

---

# Subminiature LED Lamps

## Technical Data

---

**HLMP-PXXX Series**  
**HLMP-QXXX Series**  
**HLMP-6XXX Series**  
**HLMP-70XX Series**

---

### Features

- **Subminiature Flat Top Package**  
Ideal for Backlighting and Light Piping Applications
- **Subminiature Dome Package**  
Diffused Dome for Wide Viewing Angle  
Nondiffused Dome for High Brightness
- **TTL and LSTTL Compatible 5 Volt Resistor Lamps**
- **Available in Six Colors**
- **Ideal for Space Limited Applications**
- **Axial Leads**
- **Available with Lead Configurations for Surface Mount and Through Hole PC Board Mounting**

### Description

#### Flat Top Package

The HLMP-PXXX Series flat top lamps use an untinted, non-diffused, truncated lens to provide a wide radiation pattern that is necessary for use in backlighting applications. The flat top lamps are also ideal for use as emitters in light pipe applications.

#### Dome Packages

The HLMP-6XXX Series dome lamps for use as indicators use a tinted, diffused lens to provide a wide viewing angle with a high on-off contrast ratio. High brightness lamps use an untinted, nondiffused lens to provide a high luminous intensity within a narrow radiation pattern.

#### Resistor Lamps

The HLMP-6XXX Series 5 volt subminiature lamps with built in current limiting resistors are for use in applications where space is at a premium.

#### Lead Configurations

All of these devices are made by encapsulating LED chips on axial lead frames to form molded epoxy subminiature lamp packages. A variety of package configuration options is available. These include



special surface mount lead configurations, gull wing, yoke lead or Z-bend. Right angle lead bends at 2.54 mm (0.100 inch) and 5.08 mm (0.200 inch) center spacing are available for through hole mounting. For more information refer to Standard SMT and Through Hole Lead Bend Options for Subminiature LED Lamps data sheet.

## Device Selection Guide

### Part Number: HLMP-XXXX

Standard Red	DHAS AlGaAs Red	High Efficiency Red	Orange	Yellow	High Perf. Green	Emerald Green	Device Description <sup>[1]</sup>	Device Outline Drawing
	P105	P205	P405	P305	P505	P605	Untinted, Nondiffused, Flat Top	A
	P102	P202	P402	P302	P502		Untinted, Diffused, Flat Top	B
6000/6001	Q101	6300	Q400	6400	6500	Q600	Tinted, Diffused	
	Q105	6305		6405	6505		Untinted, Nondiffused, High Brightness	
	Q150	7000		7019	7040		Tinted, Diffused, Low Current	B
	Q155						Nondiffused, Low Current	
		6600		6700	6800		Tinted, Diffused, Resistor, 5 V, 10 mA	
		6620		6720	6820		Diffused, Resistor, 5 V, 4 mA	

## Package Dimensions

### (A) Flat Top Lamps

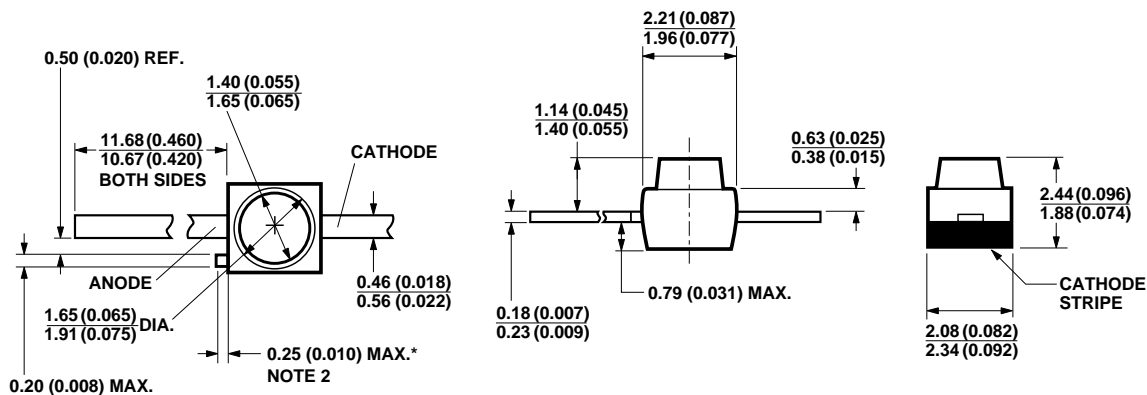

#### NOTES:

1. ALL DIMENSIONS ARE IN MILLIMETRES (INCHES).
2. PROTRUDING SUPPORT TAB IS CONNECTED TO CATHODE LEAD.

\* REFER TO FIGURE 1 FOR DESIGN CONCERNS.

## Package Dimensions (cont.)

### (B) Diffused and Nondiffused

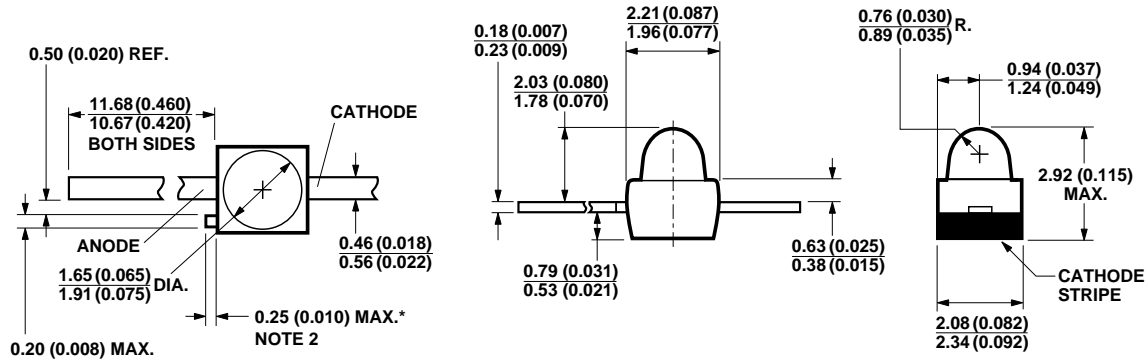

#### NOTES:

1. ALL DIMENSIONS ARE IN MILLIMETRES (INCHES).
2. PROTRUDING SUPPORT TAB IS CONNECTED TO CATHODE LEAD.

\* REFER TO FIGURE 1 FOR DESIGN CONCERNS.

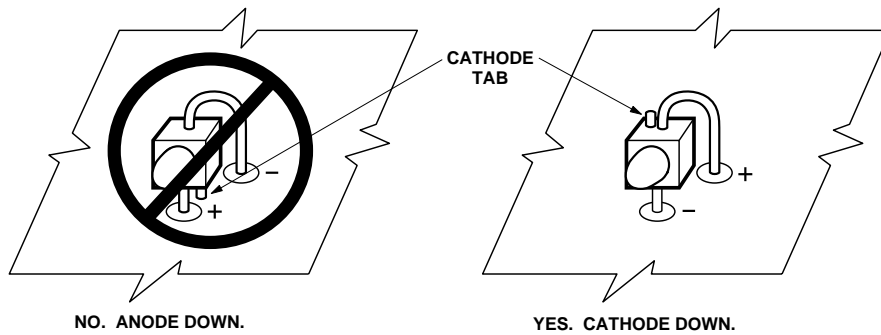

**Figure 1. Proper Right Angle Mounting to a PC Board to Prevent Protruding Cathode Tab from Shorting to Anode Connection.**

### Absolute Maximum Ratings at $T_A = 25^\circ\text{C}$

Parameter	Standard Red	DHAS AlGaAs Red	High Eff. Red	Orange	Yellow	High Perf. Green	Emerald Green	Units
DC Forward Current <sup>[1]</sup>	50	30	30	30	20	30	30	mA
Peak Forward Current <sup>[2]</sup>	1000	300	90	90	60	90	90	mA
DC Forward Voltage (Resistor Lamps Only)			6		6	6	6	V
Reverse Voltage ( $I_R = 100 \mu\text{A}$ )	5	5	5	5	5	5	5	V
Transient Forward Current <sup>[3]</sup> (10 $\mu\text{s}$ Pulse)	2000	500	500	500	500	500	500	mA
Operating Temperature Range: Non-Resistor Lamps	-55 to +100	-40 to +100	-55 to +100			-40 to +100	-20 to +100	°C
Resistor Lamps			-40 to +85			-20 to +85		
Storage Temperature Range	-55 to +100							°C
For Thru Hole Devices Wave Soldering Temperature [1.6 mm (0.063 in.) from body]	260°C for 5 Seconds							
For Surface Mount Devices: Convective IR	235°C for 90 Seconds							
Vapor Phase	215°C for 3 Minutes							

#### Notes:

1. See Figure 5 for current derating vs. ambient temperature. Derating is not applicable to resistor lamps.
2. Refer to Figure 6 showing Max. Tolerable Peak Current vs. Pulse Duration to establish pulsed operating conditions.
3. The transient peak current is the maximum non-recurring peak current the device can withstand without failure. Do not operate these lamps at this high current.

## Electrical/Optical Characteristics, $T_A = 25^\circ\text{C}$

### Standard Red

Device HLMP-	Parameter	Symbol	Min.	Typ.	Max.	Units	Test Conditions
6000	Luminous Intensity <sup>[1]</sup>	$I_v$	0.5	1.2		mcd	$I_F = 10 \text{ mA}$
6001			1.3	3.2			
All	Forward Voltage	$V_F$	1.4	1.6	2.0	V	$I_F = 10 \text{ mA}$
	Reverse Breakdown Voltage	$V_R$	5.0	12.0		V	$I_R = 100 \mu\text{A}$
P005	Included Angle Between Half Intensity Points <sup>[2]</sup>	$2\theta^{1/2}$		125		Deg.	
All Others				90			
All	Peak Wavelength	$\lambda_{\text{PEAK}}$		655		nm	
	Dominant Wavelength <sup>[3]</sup>	$\lambda_d$		640		nm	
	Spectral Line Half Width	$\Delta\lambda_{1/2}$		24		nm	
	Speed of Response	$\tau_s$		15		ns	
	Capacitance	C		100		pF	$V_F = 0; f = 1 \text{ MHz}$
	Thermal Resistance	$R\theta_{\text{J-PIN}}$		170		$^\circ\text{C/W}$	Junction-to-Cathode Lead
	Luminous Efficacy <sup>[4]</sup>	$\eta_v$		65		lm/W	

**DHASAlGaAs Red**

Device HLMP-	Parameter	Symbol	Min.	Typ.	Max.	Units	Test Conditions
P102	Luminous Intensity	$I_v$	4.0	20.0		mcd	$I_F = 20 \text{ mA}$
P105			8.6	30.0			
Q101			22.0	45.0			
Q105			100	200			$I_F = 1 \text{ mA}$
Q150			1.0	1.8			
Q155			2.0	4.0			
Q101	Forward Voltage	$V_F$		1.8	2.2	V	$I_F = 20 \text{ mA}$
P205/P505 Q101/Q105				1.8	2.2		$I_F = 1 \text{ mA}$
Q150/Q155				1.6	1.8		
All	Reverse Breakdown Voltage	$V_R$	5.0	15.0		V	$I_R = 100 \mu\text{A}$
P105	Included Angle Between Half Intensity Points <sup>[2]</sup>	$2\theta^{1/2}$		125		Deg.	
Q101/Q150				90			
Q105/Q155				28			
All	Peak Wavelength	$\lambda_{\text{PEAK}}$		645		nm	Measured at Peak
	Dominant Wavelength <sup>[3]</sup>	$\lambda_d$		637		nm	
	Spectral Line Half Width	$\Delta\lambda_{1/2}$		20		nm	
	Speed of Response	$\tau_s$		30		ns	Exponential Time Constant; $e^{-t/\tau_s}$
	Capacitance	C		30		pF	$V_F = 0$ ; $f = 1 \text{ MHz}$
	Thermal Resistance	$R\theta_{\text{J-PIN}}$		170		$^{\circ}\text{C/W}$	Junction-to Cathode Lead
	Luminous Efficacy <sup>[4]</sup>	$\eta_v$		80		lm/W	

**High Efficiency Red**

Device HLMP-	Parameter	Symbol	Min.	Typ.	Max.	Units	Test Conditions
P202	Luminous Intensity <sup>[1]</sup>	$I_v$	1.0	5.0		mcd	$I_F = 10 \text{ mA}$
P205			1.0	8.0			
6300			1.0	10.0			
6305			16.0	24.0			
7000			0.4	1.0			$I_F = 2 \text{ mA}$
6600			1.3	5.0			$V_F = 5.0 \text{ Volts}$
6620			0.8	2.0			
6653 to 6658			1.0	3.0			$I_F = 10 \text{ mA}$
All	Forward Voltage (Nonresistor Lamps)	$V_F$	1.5	1.8	3.0	V	$I_F = 10 \text{ mA}$
6600	Forward Current (Resistor Lamps)	$I_F$		9.6	13.0	mA	$V_F = 5.0 \text{ V}$
6620				3.5	5.0		
All	Reverse Breakdown Voltage	$V_R$	5.0	30.0		V	$I_R = 100 \mu\text{A}$
P205	Included Angle Between Half Intensity Points <sup>[2]</sup>	$2\theta^{1/2}$		125		Deg.	
6305				28			
All Diffused				90			
All	Peak Wavelength	$\lambda_{\text{PEAK}}$		635		nm	Measured at Peak
	Dominant Wavelength <sup>[3]</sup>	$\lambda_d$		626		nm	
	Spectral Line Half Width	$\Delta\lambda_{1/2}$		40		nm	
	Speed of Response	$\tau_s$		90		ns	
	Capacitance	C		11		pF	$V_F = 0; f = 1 \text{ MHz}$
	Thermal Resistance	$R\theta_{\text{J-PIN}}$		170		$^{\circ}\text{C/W}$	Junction-to-Cathode Lead
	Luminous Efficacy <sup>[4]</sup>	$\eta_v$		145		lm/W	

**Orange**

Device HLMP-	Parameter	Symbol	Min.	Typ.	Max.	Units	Test Conditions
P402	Luminous Intensity	$I_v$	1.0	4.0		mcd	$I_F = 10 \text{ mA}$
P405			1.0	6			
Q400			1.0	8			
All	Forward Voltage	$V_F$	1.5	1.9	3.0	V	$I_F = 10 \text{ mA}$
	Reverse Breakdown Voltage	$V_R$	5.0	30.0		V	$I_R = 100 \text{ } \mu\text{A}$
P405	Included Angle Between Half Intensity Points <sup>[2]</sup>	$2\theta^{1/2}$		125		Deg.	
Q400				90			
All	Peak Wavelength	$\lambda_{\text{PEAK}}$		600		nm	
	Dominant Wavelength <sup>[3]</sup>	$\lambda_d$		602		nm	Measured at Peak
	Spectral Line Half Width	$\Delta\lambda_{1/2}$		40		nm	
	Speed of Response	$\tau_s$		260		ns	
	Capacitance	C		4		pF	$V_F = 0; f = 1 \text{ MHz}$
	Thermal Resistance	$R\theta_{\text{J-PIN}}$		170		$^{\circ}\text{C/W}$	Junction-to-Cathode Lead
	Luminous Efficacy <sup>[4]</sup>	$\eta_v$		380		lm/W	



**Yellow**

Device HLMP-	Parameter	Symbol	Min.	Typ.	Max.	Units	Test Conditions
P302	Luminous Intensity <sup>[1]</sup>	$I_v$	1.0	3.0		mcd	$I_F = 10 \text{ mA}$
P305			1.0	4.0			
6400			1.0	9.0			
6405			3.6	20			$I_F = 2 \text{ mA}$
7019			0.4	0.6			
6700			1.4	5.0			$V_F = 5.0 \text{ Volts}$
6720			0.9	2.0			$I_F = 10 \text{ mA}$
6753 to 6758			1.0	3.0			
All	Forward Voltage (Nonresistor Lamps)	$V_F$		2.0	2.4	V	$I_F = 10 \text{ mA}$
6700	Forward Current (Resistor Lamps)	$I_F$		9.6	13.0	mA	$V_F = 5.0 \text{ V}$
6720				3.5	5.0		
All	Reverse Breakdown Voltage	$V_R$	5.0	50.0		V	
P305	Included Angle Between Half Intensity Points <sup>[2]</sup>	$2\theta^{1/2}$		125		Deg.	
6405				28			
All Diffused				90			
All	Peak Wavelength	$\lambda_{\text{PEAK}}$		583		nm	Measured at Peak
	Dominant Wavelength <sup>[3]</sup>	$\lambda_d$		585		nm	
	Spectral Line Half Width	$\Delta\lambda_{1/2}$		36		nm	
	Speed of Response	$\tau_s$		90		ns	
	Capacitance	C		15		pF	$V_F = 0; f = 1 \text{ MHz}$
	Thermal Resistance	$R\theta_{\text{J-PIN}}$		170		$^{\circ}\text{C/W}$	Junction-to-Cathode Lead
	Luminous Efficacy <sup>[4]</sup>	$\eta_v$		500		lm/W	

### High Performance Green

Device HLMP-	Parameter	Symbol	Min.	Typ.	Max.	Units	Test Conditions
P502	Luminous Intensity <sup>[1]</sup>	$I_v$	1.0	3.0		mcd	$I_F = 10 \text{ mA}$
P505			4	6.0			
6500			1.0	7.0			
6505			25	50.0			
7040			0.4	0.6			$I_F = 2 \text{ mA}$
6800			1.6	5.0			$V_F = 5.0 \text{ Volts}$
6820			0.8	2.0			
6853 to 6858			1.0	3.0			$I_F = 10 \text{ mA}$
All	Forward Voltage (Nonresistor Lamps)	$V_F$		2.1	2.7	V	$I_F = 10 \text{ mA}$
6800	Forward Current (Resistor Lamps)	$I_F$		9.6	13.0	mA	$V_F = 5.0 \text{ V}$
6820				3.5	5.0		
All	Reverse Breakdown Voltage	$V_R$	5.0	50.0		V	$I_R = 100 \mu\text{A}$
P505	Included Angle Between Half Intensity Points <sup>[2]</sup>	$2\theta^{1/2}$		125		Deg.	
6505				28			
All Diffused				90			
All	Peak Wavelength	$\lambda_{\text{PEAK}}$		565		nm	
	Dominant Wavelength <sup>[3]</sup>	$\lambda_d$		569		nm	
	Spectral Line Half Width	$\Delta\lambda_{1/2}$		28		nm	
	Speed of Response	$\tau_s$		500		ns	
	Capacitance	C		18		pF	$V_F = 0; f = 1 \text{ MHz}$
	Thermal Resistance	$R\theta_{\text{J-PIN}}$		170		$^{\circ}\text{C/W}$	Junction-to-Cathode Lead
	Luminous Efficacy <sup>[4]</sup>	$\eta_v$		595		lm/W	

#### Notes:

- The luminous intensity for arrays is tested to assure a 2.1 to 1.0 matching between elements. The average luminous intensity for an array determines its light output category bin. Arrays are binned for luminous intensity to allow  $I_v$  matching between arrays.
- $\theta^{1/2}$  is the off-axis angle where the luminous intensity is half the on-axis value.
- Dominant wavelength,  $\lambda_d$ , is derived from the CIE Chromaticity Diagram and represents the single wavelength that defines the color of the device.
- Radiant intensity,  $I_e$ , in watts/steradian, may be calculated from the equation  $I_e = I_v / \eta_v$ , where  $I_v$  is the luminous intensity in candelas and  $\eta_v$  is the luminous efficacy in lumens/watt.

**Emerald Green<sup>[1]</sup>**

Device HLMP-	Parameter	Symbol	Min.	Typ.	Max.	Units	Test Conditions
P605	Luminous Intensity	$I_v$	1.0	1.5		mcd	$I_F = 10 \text{ mA}$
Q600			1.0	1.5			
	Forward Voltage	$V_F$		2.2	3.0	V	$I_F = 10 \text{ mA}$
	Reverse Breakdown Voltage	$V_R$	5.0			V	$I_R = 100 \mu\text{A}$
P605	Included Angle Between Half Intensity Points <sup>[2]</sup>	$2\theta^{1/2}$		125		Deg.	
Q600				90			
P605/ Q600	Peak Wavelength	$\lambda_{\text{PEAK}}$		558		nm	
	Dominant Wavelength <sup>[3]</sup>	$\lambda_d$		560		nm	Measured at Peak
	Spectral Line Half Width	$\Delta\lambda_{1/2}$		24		nm	
	Speed of Response	$\tau_s$		3100		ns	
	Capacitance	C		35		pF	$V_F = 0; f = 1 \text{ MHz}$
	Thermal Resistance	$R\theta_{\text{J-PIN}}$		170		$^{\circ}\text{C/W}$	Junction-to-Cathode Lead
	Luminous Efficacy <sup>[4]</sup>	$\eta_v$		656		lm/W	

**Note:**

1. Please refer to Application Note 1061 for information comparing standard green and emerald green light output degradation.

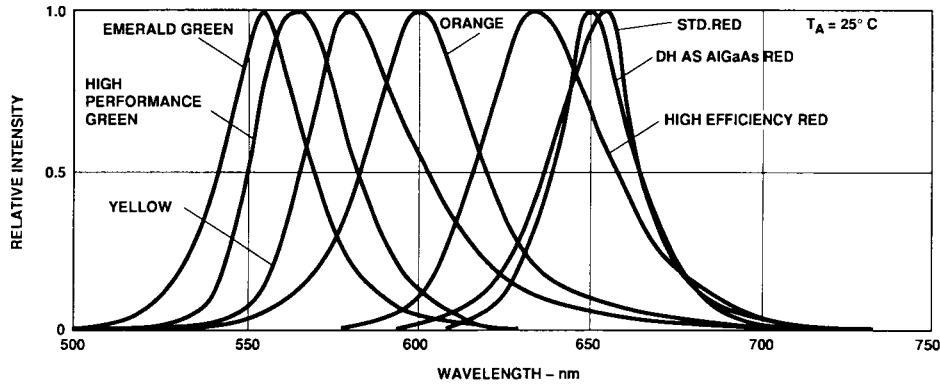

Figure 1. Relative Intensity vs. Wavelength.

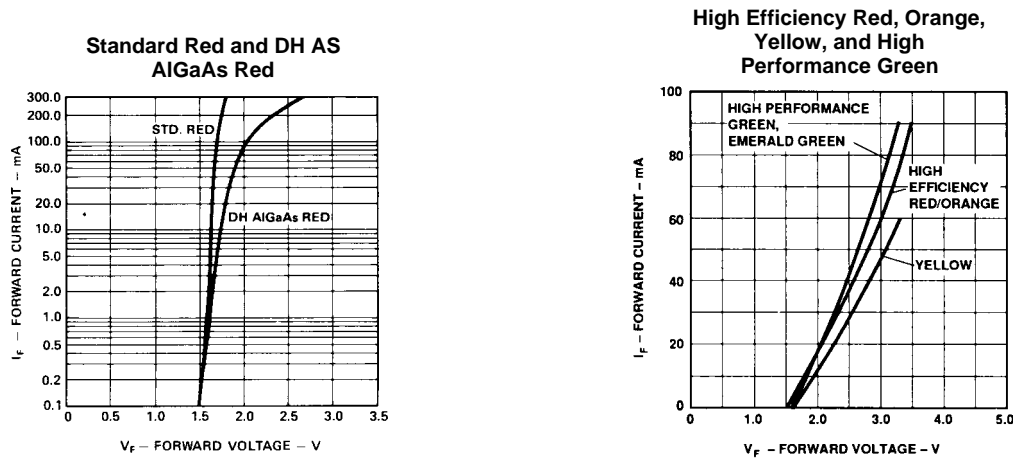

Figure 2. Forward Current vs. Forward Voltage. (Non-Resistor Lamp)

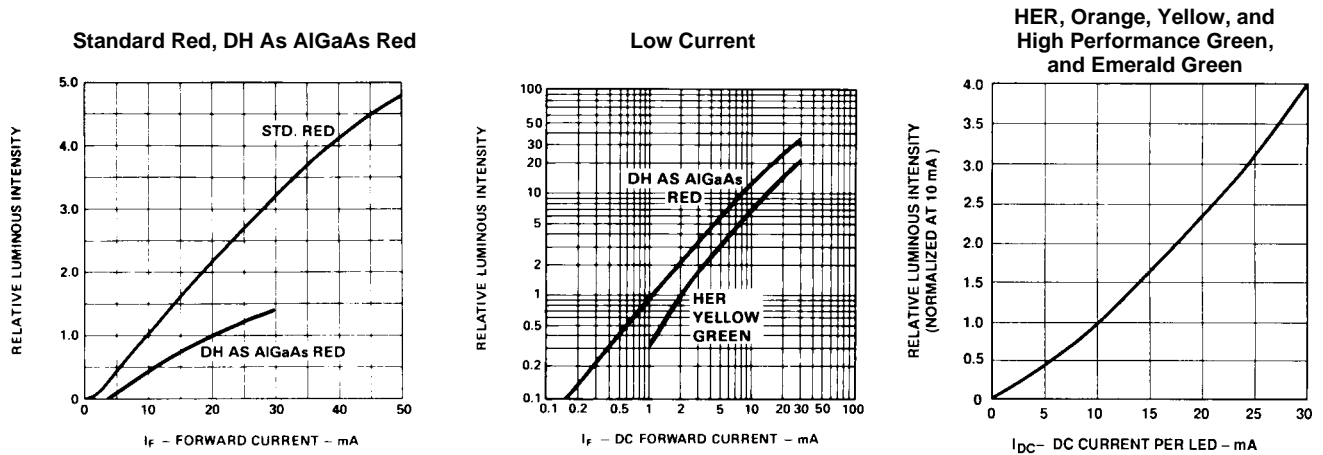

Figure 3. Relative Luminous Intensity vs. Forward Current. (Non-Resistor Lamp)

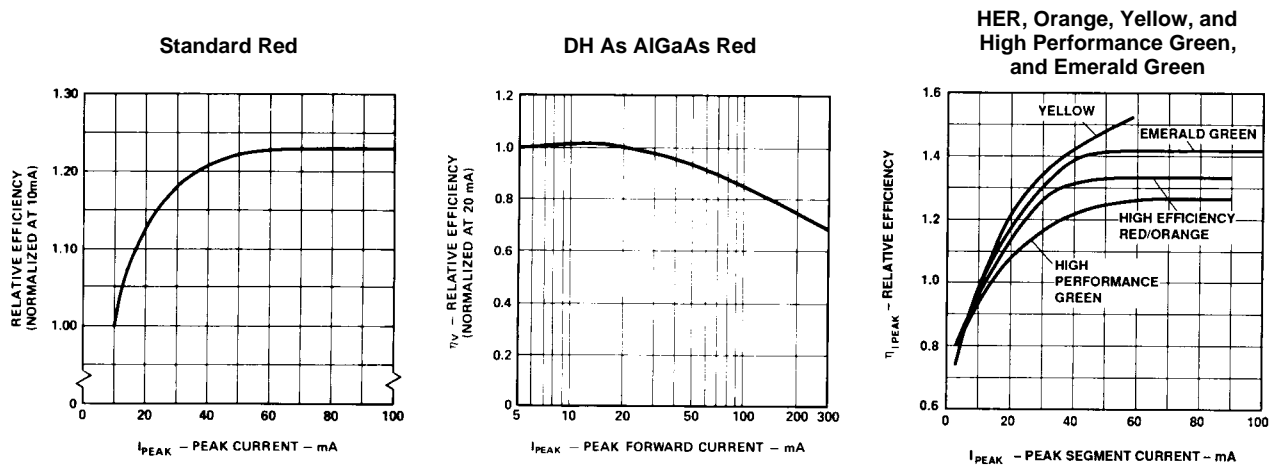

Figure 4. Relative Efficiency (Luminous Intensity per Unit Current) vs. Peak Current (Non-Resistor Lamps).

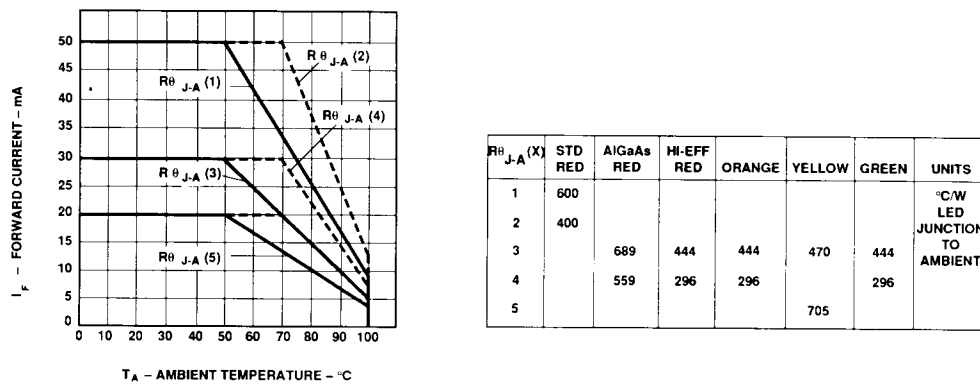

Figure 5. Maximum Forward dc Current vs. Ambient Temperature. Derating Based on T<sub>J</sub>,MAX = 110 °C (Non-Resistor Lamps).

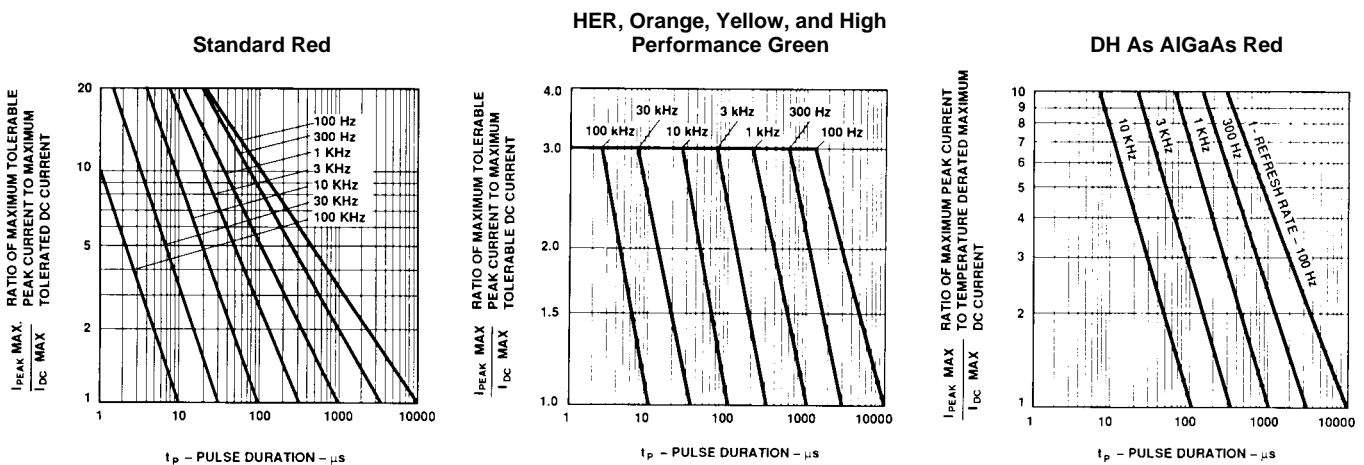

Figure 6. Maximum Tolerable Peak Current vs. Pulse Duration. (I<sub>DC</sub> MAX as per MAX Ratings) (Non-Resistor Lamps).

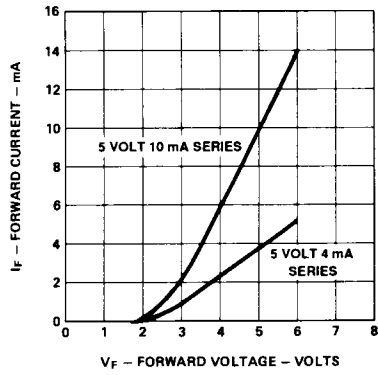

Figure 7. Resistor Lamp Forward Current vs. Forward Voltage.

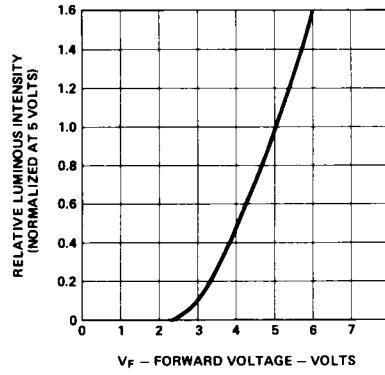

Figure 8. Resistor Lamp Luminous Intensity vs. Forward Voltage.

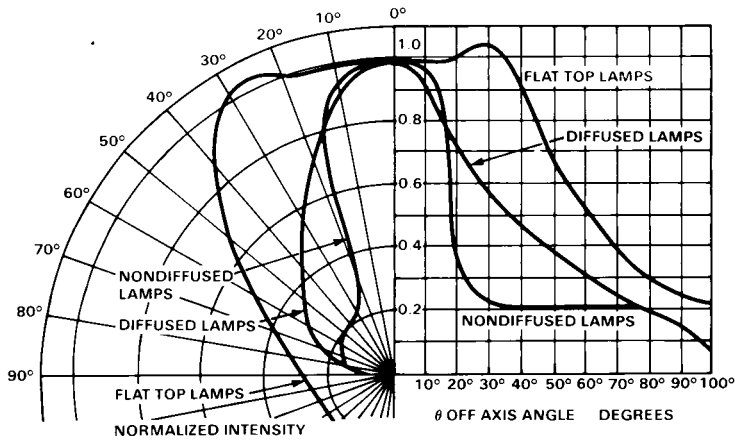

Figure 9. Relative Intensity vs. Angular Displacement.





*[www.hp.com/go/led](http://www.hp.com/go/led)*

For technical assistance or the location of your nearest Hewlett-Packard sales office, distributor or representative call:

**Americas/Canada:** 1-800-235-0312 or 408-654-8675

**Far East/Australasia:** Call your local HP sales office.

**Japan:** (81 3) 3335-8152

**Europe:** Call your local HP sales office.

Data subject to change.

Copyright © 1999 Hewlett-Packard Co.

Obsoletes 5964-9350E (4/96)

5968-2537E (2/99)