

**225 mW SOT-23**  
**Zener Voltage Regulator Diodes**  
**GENERAL DATA APPLICABLE TO ALL SERIES IN**  
**THIS GROUP**  
**Zener Voltage**  
**Regulator Diodes**

**Manufacturing Locations:**

**WAFER FAB:** Phoenix, Arizona

**ASSEMBLY:** Seremban, Malaysia

**TEST:** Seremban, Malaysia

**MAXIMUM CASE TEMPERATURE FOR SOLDERING**

**PURPOSES:** 260°C for 10 seconds

**THERMAL CHARACTERISTICS**

Characteristic	Symbol	Max	Unit
Total Device Dissipation FR-5 Board,* T <sub>A</sub> = 25°C Derate above 25°C	P <sub>D</sub>	225 1.8	mW mW/°C
Thermal Resistance Junction to Ambient	R <sub>θJA</sub>	556	°C/W
Total Device Dissipation Alumina Substrate,** T <sub>A</sub> = 25°C Derate above 25°C	P <sub>D</sub>	300 2.4	mW mW/°C
Thermal Resistance Junction to Ambient	R <sub>θJA</sub>	417	°C/W
Junction and Storage Temperature	T <sub>J</sub> , T <sub>stg</sub>	150	°C

\*FR-5 = 1.0 x 0.75 x 0.62 in.

\*\*Alumina = 0.4 x 0.3 x 0.024 in. 99.5% alumina.

**GENERAL**  
**DATA**  
**225 mW**  
**SOT-23**

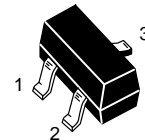
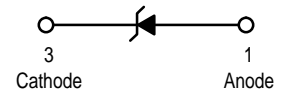

**CASE 318-07, STYLE 8**  
**SOT-23 (TO-236AB)**  
**PLASTIC**

# GENERAL DATA — 225 mW SOT-23

## TYPICAL CHARACTERISTICS

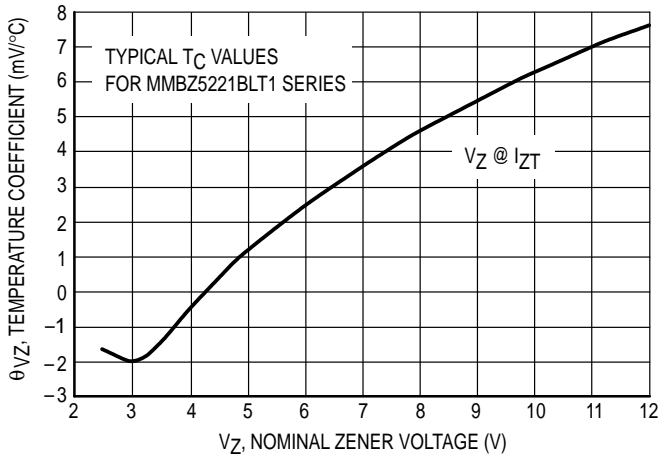

**Figure 1. Temperature Coefficients**  
(Temperature Range  $-55^\circ\text{C}$  to  $+150^\circ\text{C}$ )

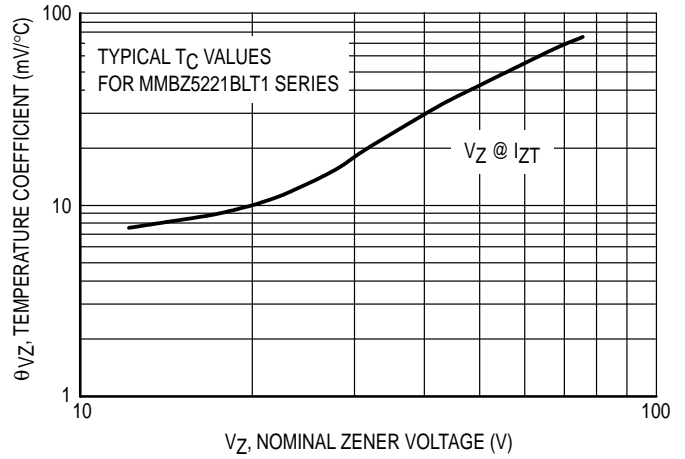

**Figure 2. Temperature Coefficients**  
(Temperature Range  $-55^\circ\text{C}$  to  $+150^\circ\text{C}$ )

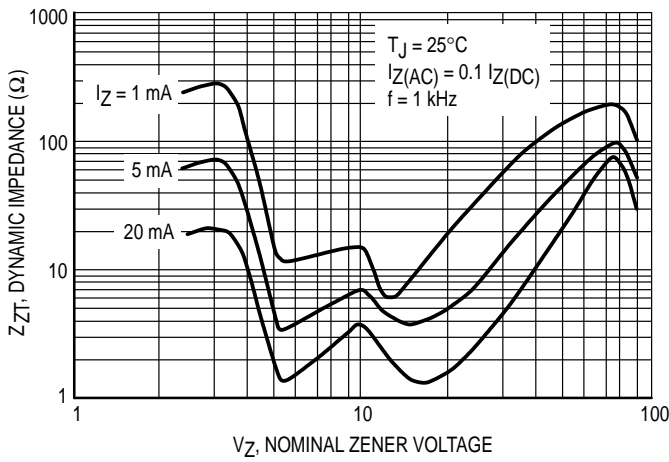

**Figure 3. Effect of Zener Voltage on**  
**Zener Impedance**

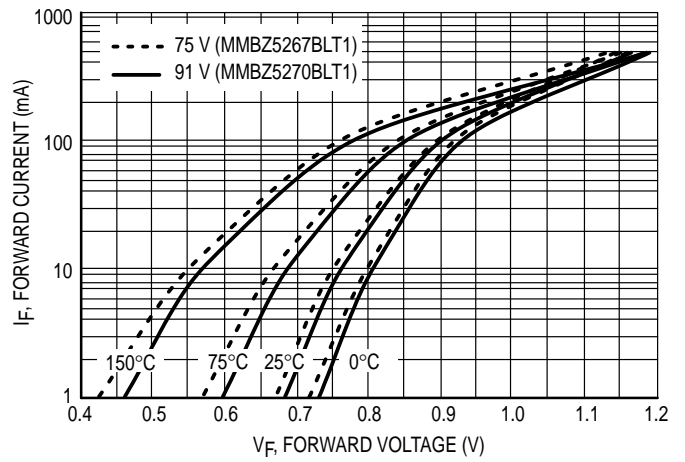

**Figure 4. Typical Forward Voltage**

# GENERAL DATA — 225 mW SOT-23

## TYPICAL CHARACTERISTICS

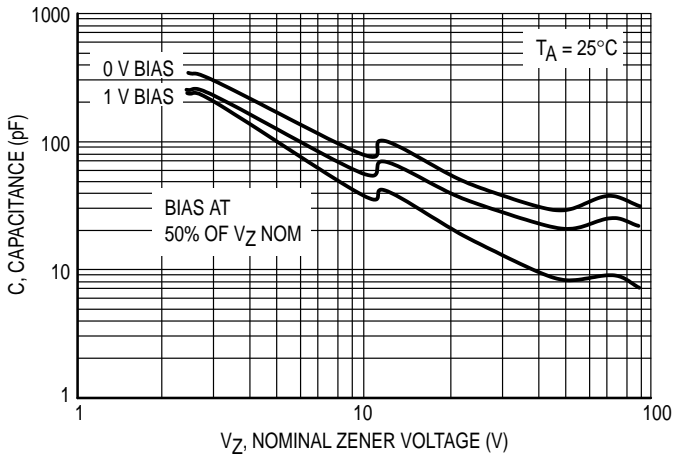

Figure 5. Typical Capacitance

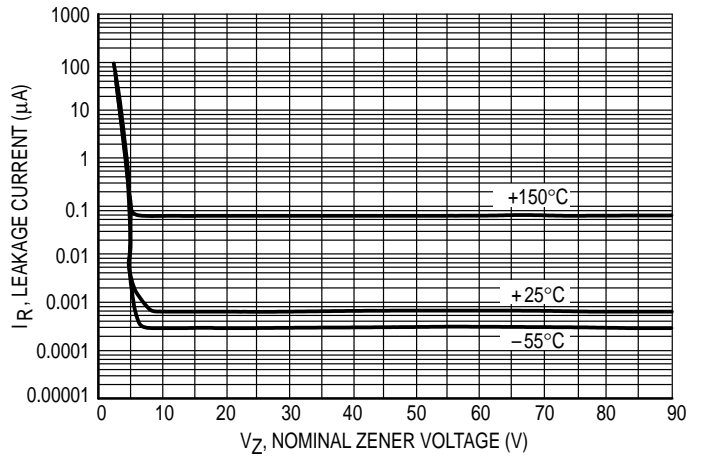

Figure 6. Typical Leakage Current

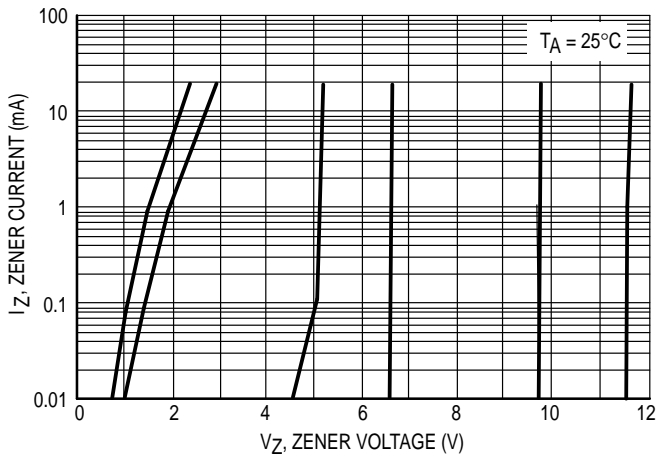

Figure 7. Zener Voltage versus Zener Current  
( $V_Z$  Up to 12 V)

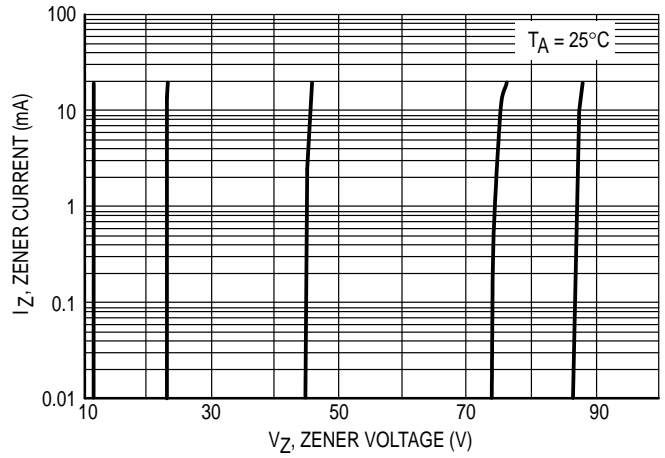

Figure 8. Zener Voltage versus Zener Current  
(12 V to 91 V)

# GENERAL DATA — 225 mW SOT-23

## ELECTRICAL CHARACTERISTICS (Pinout: 1-Anode, 2-NC, 3-Cathode) ( $V_F = 0.9\text{ V Max @ } I_F = 10\text{ mA}$ for all types)

Type Number	Marking	Zener Voltage $V_{Z1}$ (Volts) @ $I_{Z1} = 5\text{ mA}$ (Note 1)			Max Zener Impedance $Z_{ZT1}$ (Ohms) @ $I_{Z1} = 5\text{ mA}$	Max Reverse Leakage Current		Zener Voltage $V_{Z2}$ (Volts) @ $I_{Z2} = 1\text{ mA}$ (Note 1)		Max Zener Impedance $Z_{ZT2}$ (Ohms) @ $I_{Z2} = 1\text{ mA}$	Zener Voltage $V_{Z3}$ (Volts) @ $I_{Z3} = 20\text{ mA}$ (Note 1)		Max Zener Impedance $Z_{ZT3}$ (Ohms) @ $I_{Z3} = 20\text{ mA}$	$dV_Z/dt$ (mV/k) @ $I_{Z1} = 5\text{ mA}$		C pF Max @ $V_R = 0$ $f = 1\text{ MHz}$
		Nom	Min	Max		$I_R$ $\mu\text{A}$	$V_R$ Volts	Min	Max		Min	Max		Min	Max	
BZX84C2V4LT1	Z11	2.4	2.2	2.6	100	50	1	1.7	2.1	600	2.6	3.2	50	-3.5	0	450
BZX84C2V7LT1	Z12	2.7	2.5	2.9	100	20	1	1.9	2.4	600	3	3.6	50	-3.5	0	450
BZX84C3V0LT1	Z13	3	2.8	3.2	95	10	1	2.1	2.7	600	3.3	3.9	50	-3.5	0	450
BZX84C3V3LT1	Z14	3.3	3.1	3.5	95	5	1	2.3	2.9	600	3.6	4.2	40	-3.5	0	450
BZX84C3V6LT1	Z15	3.6	3.4	3.8	90	5	1	2.7	3.3	600	3.9	4.5	40	-3.5	0	450
BZX84C3V9LT1	Z16	3.9	3.7	4.1	90	3	1	2.9	3.5	600	4.1	4.7	30	-3.5	-2.5	450
BZX84C4V3LT1	W9	4.3	4	4.6	90	3	1	3.3	4	600	4.4	5.1	30	-3.5	0	450
<b>BZX84C4V7LT1</b>	<b>Z1</b>	<b>4.7</b>	<b>4.4</b>	<b>5</b>	<b>80</b>	<b>3</b>	<b>2</b>	<b>3.7</b>	<b>4.7</b>	<b>500</b>	<b>4.5</b>	<b>5.4</b>	<b>15</b>	<b>-3.5</b>	<b>0.2</b>	<b>260</b>
<b>BZX84C5V1LT1</b>	<b>Z2</b>	<b>5.1</b>	<b>4.8</b>	<b>5.4</b>	<b>60</b>	<b>2</b>	<b>2</b>	<b>4.2</b>	<b>5.3</b>	<b>480</b>	<b>5</b>	<b>5.9</b>	<b>15</b>	<b>-2.7</b>	<b>1.2</b>	<b>225</b>
<b>BZX84C5V6LT1</b>	<b>Z3</b>	<b>5.6</b>	<b>5.2</b>	<b>6</b>	<b>40</b>	<b>1</b>	<b>2</b>	<b>4.8</b>	<b>6</b>	<b>400</b>	<b>5.2</b>	<b>6.3</b>	<b>10</b>	<b>-2.0</b>	<b>2.5</b>	<b>200</b>
<b>BZX84C6V2LT1</b>	<b>Z4</b>	<b>6.2</b>	<b>5.8</b>	<b>6.6</b>	<b>10</b>	<b>3</b>	<b>4</b>	<b>5.6</b>	<b>6.6</b>	<b>150</b>	<b>5.8</b>	<b>6.8</b>	<b>6</b>	<b>0.4</b>	<b>3.7</b>	<b>185</b>
BZX84C6V8LT1	Z5	6.8	6.4	7.2	15	2	4	6.3	7.2	80	6.4	7.4	6	1.2	4.5	155
BZX84C7V5LT1	Z6	7.5	7	7.9	15	1	5	6.9	7.9	80	7	8	6	2.5	5.3	140
BZX84C8V2LT1	Z7	8.2	7.7	8.7	15	0.7	5	7.6	8.7	80	7.7	8.8	6	3.2	6.2	135
BZX84C9V1LT1	Z8	9.1	8.5	9.6	15	0.5	6	8.4	9.6	100	8.5	9.7	8	3.8	7.0	130
BZX84C10LT1	Z9	10	9.4	10.6	20	0.2	7	9.3	10.6	150	9.4	10.7	10	4.5	8.0	130
BZX84C11LT1	Y1	11	10.4	11.6	20	0.1	8	10.2	11.6	150	10.4	11.8	10	5.4	9.0	130
<b>BZX84C12LT1</b>	<b>Y2</b>	<b>12</b>	<b>11.4</b>	<b>12.7</b>	<b>25</b>	<b>0.1</b>	<b>8</b>	<b>11.2</b>	<b>12.7</b>	<b>150</b>	<b>11.4</b>	<b>12.9</b>	<b>10</b>	<b>6.0</b>	<b>10.0</b>	<b>130</b>
BZX84C13LT1	Y3	13	12.4	14.1	30	0.1	8	12.3	14	170	12.5	14.2	15	7.0	11.0	120
BZX84C15LT1	Y4	15	13.8	15.6	30	0.05	10.5	13.7	15.5	200	13.9	15.7	20	9.2	13.0	110
BZX84C16LT1	Y5	16	15.3	17.1	40	0.05	11.2	15.2	17	200	15.4	17.2	20	10.4	14.0	105
<b>BZX84C18LT1</b>	<b>Y6</b>	<b>18</b>	<b>16.8</b>	<b>19.1</b>	<b>45</b>	<b>0.05</b>	<b>12.6</b>	<b>16.7</b>	<b>19</b>	<b>225</b>	<b>16.9</b>	<b>19.2</b>	<b>20</b>	<b>12.4</b>	<b>16.0</b>	<b>100</b>
BZX84C20LT1	Y7	20	18.8	21.2	55	0.05	14	18.7	21.1	225	18.9	21.4	20	14.4	18.0	85
BZX84C22LT1	Y8	22	20.8	23.3	55	0.05	15.4	20.7	23.2	250	20.9	23.4	25	16.4	20.0	85
BZX84C24LT1	Y9	24	22.8	25.6	70	0.05	16.8	22.7	25.5	250	22.9	25.7	25	18.4	22.0	80
		$V_{Z1}$ Below @ $I_{Z1} = 2\text{ mA}$			$Z_{ZT1}$ Below @ $I_{Z1} = 2\text{ mA}$			$V_{Z2}$ Below @ $I_{Z2} = 0.1\text{ mA}$		$Z_{ZT2}$ Below @ $I_{Z2} = 0.5\text{ mA}$ (Note 2)	$V_{Z3}$ Below @ $I_{Z3} = 10\text{ mA}$		$Z_{ZT3}$ Below @ $I_{Z3} = 10\text{ mA}$	$dV_Z/dt$ (mV/k) Below @ $I_{Z1} = 2\text{ mA}$		
BZX84C27LT1	Y10	27	25.1	28.9	80	0.05	18.9	25	28.9	300	25.2	29.3	45	21.4	25.3	70
BZX84C30LT1	Y11	30	28	32	80	0.05	21	27.8	32	300	28.1	32.4	50	24.4	29.4	70
BZX84C33LT1	Y12	33	31	35	80	0.05	23.1	30.8	35	325	31.1	35.4	55	27.4	33.4	70
BZX84C36LT1	Y13	36	34	38	90	0.05	25.2	33.8	38	350	34.1	38.4	60	30.4	37.4	70
BZX84C39LT1	Y14	39	37	41	130	0.05	27.3	36.7	41	350	37.1	41.5	70	33.4	41.2	45
BZX84C43LT1	Y15	43	40	46	150	0.05	30.1	39.7	46	375	40.1	46.5	80	37.6	46.6	40
BZX84C47LT1	Y16	47	44	50	170	0.05	32.9	43.7	50	375	44.1	50.5	90	42.0	51.8	40
BZX84C51LT1	Y17	51	48	54	180	0.05	35.7	47.6	54	400	48.1	54.6	100	46.6	57.2	40
BZX84C56LT1	Y18	56	52	60	200	0.05	39.2	51.5	60	425	52.1	60.8	110	52.2	63.8	40
BZX84C62LT1	Y19	62	58	66	215	0.05	43.4	57.4	66	450	58.2	67	120	58.8	71.6	35
BZX84C68LT1	Y20	68	64	72	240	0.05	47.6	63.4	72	475	64.2	73.2	130	65.6	79.8	35
BZX84C75LT1	Y21	75	70	79	255	0.05	52.5	69.4	79	500	70.3	80.2	140	73.4	88.6	35

NOTES: 1. Zener voltage is measured with a pulse test current ( $I_Z$ ) applied at an ambient temperature of 25°C.

2. The zener impedance,  $Z_{ZT2}$ , for the 27 through 75 volt types is tested at 0.5 mA rather than the test current of 0.1 mA used for  $V_{Z2}$ .

# Zener Voltage Regulator Diodes — Surface Mounted

## 225 mW SOT-23

NOTES:

1. DIMENSIONING AND TOLERANCING PER ANSI Y14.5M, 1982.
2. CONTROLLING DIMENSION: INCH.
3. MAXIMUM LEAD THICKNESS INCLUDES LEAD FINISH THICKNESS. MINIMUM LEAD THICKNESS IS THE MINIMUM THICKNESS OF BASE MATERIAL.

DIM	INCHES		MILLIMETERS	
	MIN	MAX	MIN	MAX
A	0.1102	0.1197	2.80	3.04
B	0.0472	0.0551	1.20	1.40
C	0.0350	0.0440	0.89	1.11
D	0.0150	0.0200	0.37	0.50
G	0.0701	0.0807	1.78	2.04
H	0.0005	0.0040	0.013	0.100
J	0.0034	0.0070	0.085	0.177
K	0.0180	0.0236	0.45	0.60
L	0.0350	0.0401	0.89	1.02
S	0.0830	0.0984	2.10	2.50
V	0.0177	0.0236	0.45	0.60

- STYLE 8:  
 PIN 1. ANODE  
 2. NO CONNECTION  
 3. CATHODE

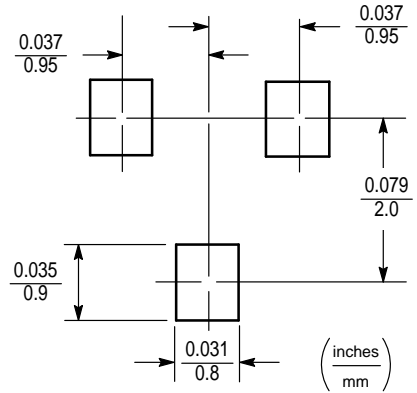
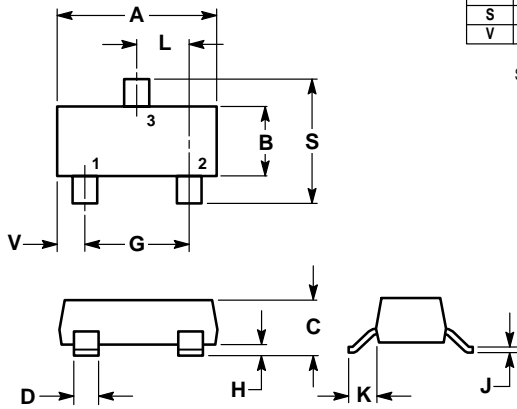

SOT-23 Footprint

CASE 318-07  
 PLASTIC

(Refer to Section 10 for Surface Mount, Thermal Data and Footprint Information.)

### MULTIPLE PACKAGE QUANTITY (MPQ) REQUIREMENTS

Package Option	Type No. Suffix	MPQ (Units)
Tape and Reel	T1	3K
Tape and Ammo	T3	10K

(Refer to Section 10 for more information on Packaging Specifications.)

# GENERAL DATA — 225 mW SOT-23

**ELECTRICAL CHARACTERISTICS (Pinout: 1-Anode, 2-NC, 3-Cathode)** ( $V_F = 0.9\text{ V Max @ } I_F = 10\text{ mA}$  for all types.)

Device	Marking	Test Current $I_{ZT}$ mA	Zener Voltage $V_Z (\pm 5\%)$ Nominal (Note 1)	ZZK $I_Z = 0.25\text{ mA}$ $\Omega$ Max	ZZT $I_Z = I_{ZT}$ @ 10% Mod $\Omega$ Max	Max $I_R$ $\mu\text{A}$	@	$V_R$ V
MMBZ5221BLT1	18A	20	2.4	1200	30	100		1
MMBZ5222BLT1	18B	20	2.5	1250	30	100		1
MMBZ5223BLT1	18C	20	2.7	1300	30	75		1
MMBZ5224BLT1	18D	20	2.8	1400	30	75		1
MMBZ5225BLT1	18E	20	3	1600	29	50		1
MMBZ5226BLT1	8A	20	3.3	1600	28	25		1
MMBZ5227BLT1	8B	20	3.6	1700	24	15		1
MMBZ5228BLT1	8C	20	3.9	1900	23	10		1
MMBZ5229BLT1	8D	20	4.3	2000	22	5		1
MMBZ5230BLT1	8E	20	4.7	1900	19	5		2
<b>MMBZ5231BLT1</b>	<b>8F</b>	<b>20</b>	<b>5.1</b>	<b>1600</b>	<b>17</b>	<b>5</b>		<b>2</b>
<b>MMBZ5232BLT1</b>	<b>8G</b>	<b>20</b>	<b>5.6</b>	<b>1600</b>	<b>11</b>	<b>5</b>		<b>3</b>
MMBZ5233BLT1	8H	20	6	1600	7	5		3.5
<b>MMBZ5234BLT1</b>	<b>8J</b>	<b>20</b>	<b>6.2</b>	<b>1000</b>	<b>7</b>	<b>5</b>		<b>4</b>
<b>MMBZ5235BLT1</b>	<b>8K</b>	<b>20</b>	<b>6.8</b>	<b>750</b>	<b>5</b>	<b>3</b>		<b>5</b>
MMBZ5236BLT1	8L	20	7.5	500	6	3		6
MMBZ5237BLT1	8M	20	8.2	500	8	3		6.5
MMBZ5238BLT1	8N	20	8.7	600	8	3		6.5
MMBZ5239BLT1	8P	20	9.1	600	10	3		7
<b>MMBZ5240BLT1</b>	<b>8Q</b>	<b>20</b>	<b>10</b>	<b>600</b>	<b>17</b>	<b>3</b>		<b>8</b>
MMBZ5241BLT1	8R	20	11	600	22	2		8.4
<b>MMBZ5242BLT1</b>	<b>8S</b>	<b>20</b>	<b>12</b>	<b>600</b>	<b>30</b>	<b>1</b>		<b>9.1</b>
MMBZ5243BLT1	8T	9.5	13	600	13	0.5		9.9
MMBZ5244BLT1	8U	9	14	600	15	0.1		10
<b>MMBZ5245BLT1</b>	<b>8V</b>	<b>8.5</b>	<b>15</b>	<b>600</b>	<b>16</b>	<b>0.1</b>		<b>11</b>
MMBZ5246BLT1	8W	7.8	16	600	17	0.1		12
MMBZ5247BLT1	8X	7.4	17	600	19	0.1		13
<b>MMBZ5248BLT1</b>	<b>8Y</b>	<b>7</b>	<b>18</b>	<b>600</b>	<b>21</b>	<b>0.1</b>		<b>14</b>
MMBZ5249BLT1	8Z	6.6	19	600	23	0.1		14
<b>MMBZ5250BLT1</b>	<b>81A</b>	<b>6.2</b>	<b>20</b>	<b>600</b>	<b>25</b>	<b>0.1</b>		<b>15</b>
MMBZ5251BLT1	81B	5.6	22	600	29	0.1		17
MMBZ5252BLT1	81C	5.2	24	600	33	0.1		18
MMBZ5253BLT1	81D	5	25	600	35	0.1		19
<b>MMBZ5254BLT1</b>	<b>81E</b>	<b>4.6</b>	<b>27</b>	<b>600</b>	<b>41</b>	<b>0.1</b>		<b>21</b>
MMBZ5255BLT1	81F	4.5	28	600	44	0.1		21
MMBZ5256BLT1	81G	4.2	30	600	49	0.1		23
<b>MMBZ5257BLT1</b>	<b>81H</b>	<b>3.8</b>	<b>33</b>	<b>700</b>	<b>58</b>	<b>0.1</b>		<b>25</b>
MMBZ5258BLT1	81J	3.4	36	700	70	0.1		27
MMBZ5259BLT1	81K	3.2	39	800	80	0.1		30
MMBZ5260BLT1	18F	3	43	900	93	0.1		33
MMBZ5261BLT1	81M	2.7	47	1000	105	0.1		36
MMBZ5262BLT1	81N	2.5	51	1100	125	0.1		39
MMBZ5263BLT1	81P	2.2	56	1300	150	0.1		43
MMBZ5264BLT1	81Q	2.1	60	1400	170	0.1		46
MMBZ5265BLT1	81R	2	62	1400	185	0.1		47
MMBZ5266BLT1	81S	1.8	68	1600	230	0.1		52
MMBZ5267BLT1	81T	1.7	75	1700	270	0.1		56
MMBZ5268BLT1	81U	1.5	82	2000	330	0.1		62
MMBZ5269BLT1	81V	1.4	87	2200	370	0.1		68
MMBZ5270BLT1	81W	1.4	91	2300	400	0.1		69

NOTE 1. Zener voltage is measured with a pulse test current ( $I_{ZT}$ ) applied at an ambient temperature of 25°C.

# Designer's™ Data Sheet

## Surface Mount Silicon Zener Diodes

### Plastic SOD-123 Package

Three complete series of Zener Diodes are offered in the convenient, surface mount plastic SOD-123 package. These devices provide a convenient alternative to the leadless 34 package style.

- 500 mW Rating on FR-4 or FR-5 Board
- Package Designed for Optimal Automated Board Assembly
- Corrosion Resistant Finish, Easily Solderable
- ESD Rating of Class 3 (exceeding 16 kV) per the Human Body Model
- Small Package Size for High Density Applications
- Available in 8 mm Tape and Reel
  - Add "T1" to the device number to order the 7 inch/3000 unit reel.
  - Add "T3" to the device number to order the 13 inch/10,000 unit reel.
- Wafer Fab Location: Phoenix, Arizona  
Assembly/Test Location: Seremban, Malaysia

#### MMSZ5221BT1 thru MMSZ5270BT1

- General Purpose, Medium Current
- Wide Voltage Range — 2.4 to 91 Volts

#### MMSZ4678T1 thru MMSZ4717T1

- Low Operating Currents, Low Leakage, Sharp Breakdown Characteristics
- Wide Voltage Range — 1.8 to 43 Volts

#### MMSZ2V4T1 thru MMSZ75T1

- Specified Similar to European BZV55C Series
- Wide Voltage Range — 2.4 to 75 Volts

**MMSZ5221BT1 -  
MMSZ5270BT1\*  
MMSZ4678T1 -  
MMSZ4717T1  
MMSZ2V4T1 -  
MMSZ75T1**

\*Motorola Preferred Device Series

**PLASTIC SURFACE  
MOUNT  
ZENER DIODES  
500 MILLIWATTS  
1.8–91 VOLTS**



**1: CATHODE  
2: ANODE**



**CASE 425, STYLE 1  
PLASTIC**

#### DEVICE RATING ( $T_A = 25^\circ\text{C}$ unless otherwise noted)

Rating	Symbol	Value	Unit
Power Dissipation on FR-4 or FR-5 Board [1] Derate above $T_L = 75^\circ\text{C}$	$P_D$ —	500 6.7	mW mW/°C
Thermal Resistance Junction to Lead [2] Thermal Resistance Junction to Ambient [2]	$R_{\theta JL}$ $R_{\theta JA}$	150 340	°C/W
Junction Temperature Range	$T_J$	-55 to +150	°C
Storage Temperature Range	$T_{stg}$	-55 to +150	°C
Lead Solder Temperature – Maximum (10 sec. duration)	—	260	°C

[1] FR-4 or FR-5 = 3.5 x 1.5 inches, using the Motorola minimum recommended footprint as shown in Figure 11.

[2] Thermal Resistance measurement obtained via Infrared Scan Method

**Designer's Data for "Worst Case" Conditions** — The Designer's Data Sheet permits the design of most circuits entirely from the information presented. Limit curves — representing boundaries on device characteristics — are given to facilitate "worst case" design.

Designer's is a trademark of Motorola, Inc.

Thermal Clad is a trademark of the Bergquist Company.

**Preferred** devices are Motorola recommended choices for future use and best overall value.

# MMSZ5221BT1, MMSZ4678T1, MMSZ2V4T1 Series

## TYPICAL CHARACTERISTICS

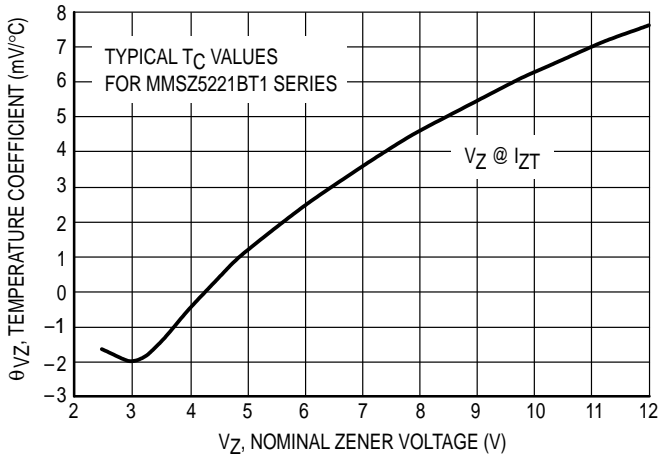

**Figure 1. Temperature Coefficients (Temperature Range -55°C to +150°C)**

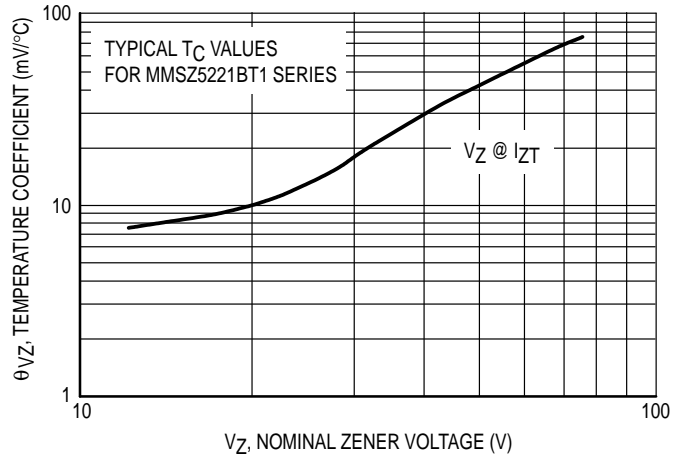

**Figure 2. Temperature Coefficients (Temperature Range -55°C to +150°C)**

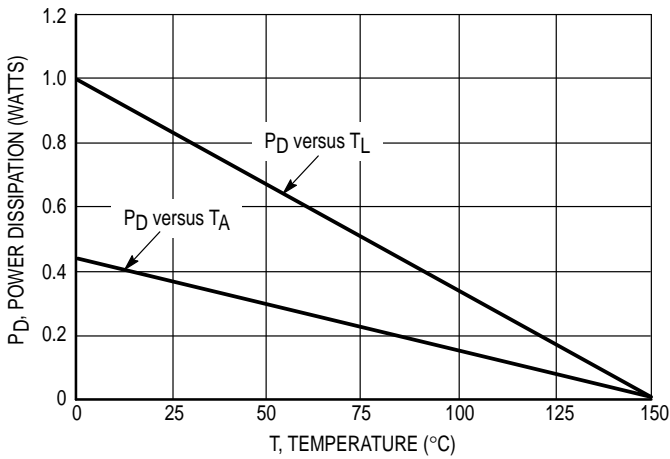

**Figure 3. Steady State Power Derating**

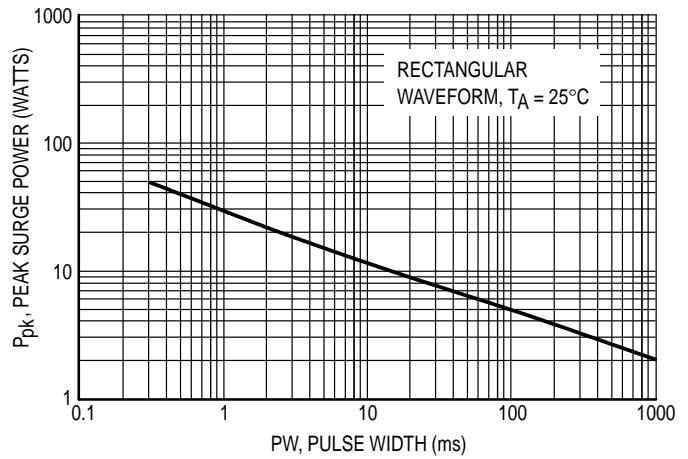

**Figure 4. Maximum Nonrepetitive Surge Power**

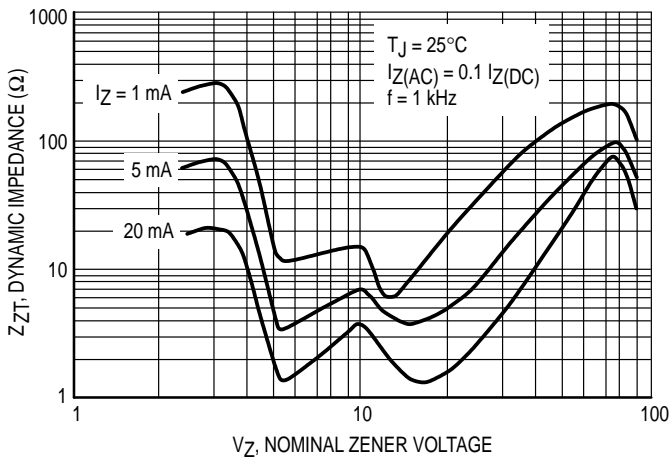

**Figure 5. Effect of Zener Voltage on Zener Impedance**

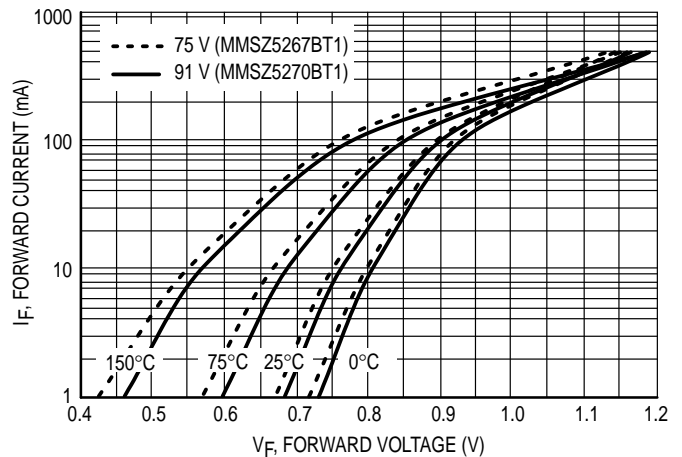

**Figure 6. Typical Forward Voltage**



# MMSZ5221BT1, MMSZ4678T1, MMSZ2V4T1 Series

## TYPICAL CHARACTERISTICS

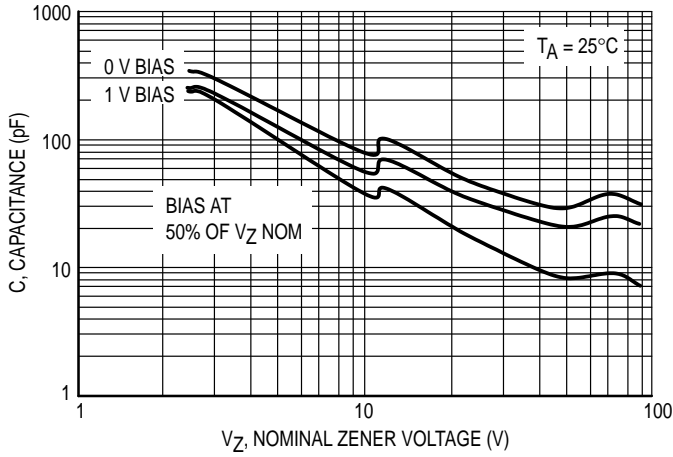

Figure 7. Typical Capacitance

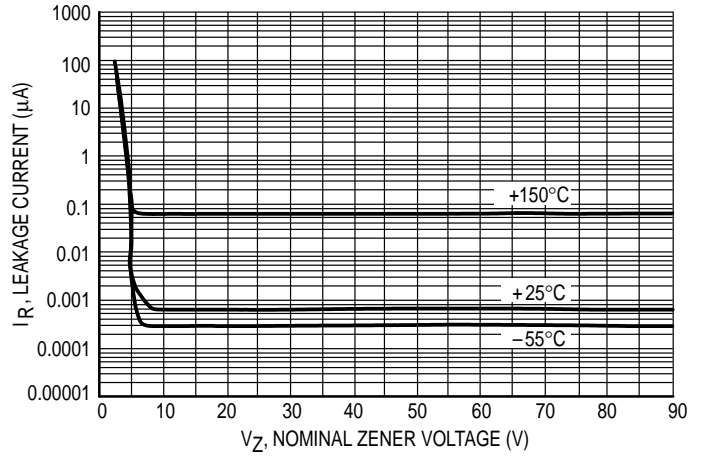

Figure 8. Typical Leakage Current

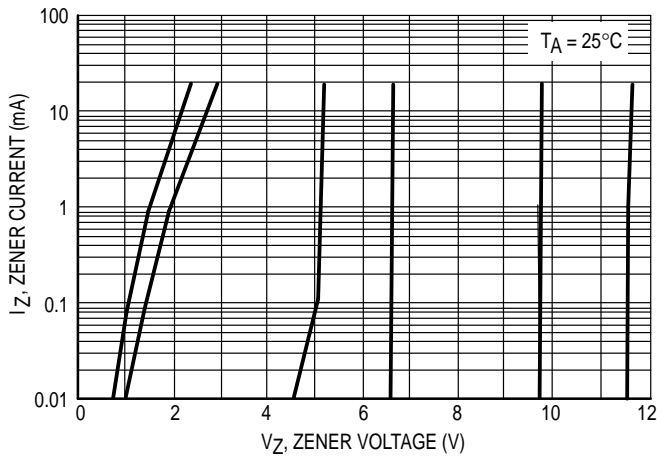

Figure 9. Zener Voltage versus Zener Current ( $V_Z$  Up to 12 V)

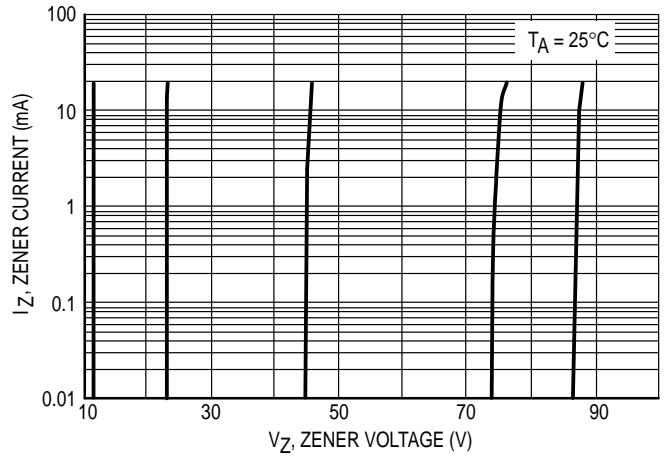

Figure 10. Zener Voltage versus Zener Current (12 V to 91 V)

# MMSZ5221BT1, MMSZ4678T1, MMSZ2V4T1 Series

**ELECTRICAL CHARACTERISTICS** ( $T_A = 25^\circ\text{C}$  unless otherwise noted [1]), ( $V_F = 0.9\text{ V Max. @ } I_F = 10\text{ mA}$  for all types)

Type Number	Marking	Zener Voltage $V_Z @ I_{ZT}$ Volts [1] [2]			Test Current $I_{ZT}$ mA	Max Zener Impedance [3]		Max Reverse Leakage Current $I_R @ V_R$ $\mu\text{A}$	Test Voltage $V_R$ Volts
		Nom	Min	Max		$Z_{ZT}$ @ $I_Z = I_{ZT}$ $\Omega$	$Z_{ZK}$ @ $I_{ZK} = 0.25\text{ mA}$ $\Omega$		
<b>MMSZ5221BT1</b>	C1	2.4	2.28	2.52	20	30	1200	100	1
<b>MMSZ5222BT1</b>	C2	2.5	2.38	2.63	20	30	1250	100	1
MMSZ5223BT1	C3	2.7	2.57	2.84	20	30	1300	75	1
MMSZ5224BT1	C4	2.8	2.66	2.94	20	30	1400	75	1
<b>MMSZ5225BT1</b>	C5	3.0	2.85	3.15	20	30	1600	50	1
MMSZ5226BT1	D1	3.3	3.14	3.47	20	28	1600	25	1
MMSZ5227BT1	D2	3.6	3.42	3.78	20	24	1700	15	1
MMSZ5228BT1	D3	3.9	3.71	4.10	20	23	1900	10	1
<b>MMSZ5229BT1</b>	D4	4.3	4.09	4.52	20	22	2000	5	1
<b>MMSZ5230BT1</b>	D5	4.7	4.47	4.94	20	19	1900	5	2
<b>MMSZ5231BT1</b>	E1	5.1	4.85	5.36	20	17	1600	5	2
<b>MMSZ5232BT1</b>	E2	5.6	5.32	5.88	20	11	1600	5	3
MMSZ5233BT1	E3	6.0	5.70	6.30	20	7	1600	5	3.5
<b>MMSZ5234BT1</b>	E4	6.2	5.89	6.51	20	7	1000	5	4
MMSZ5235BT1	E5	6.8	6.46	7.14	20	5	750	3	5
MMSZ5236BT1	F1	7.5	7.13	7.88	20	6	500	3	6
MMSZ5237BT1	F2	8.2	7.79	8.61	20	8	500	3	6.5
MMSZ5238BT1	F3	8.7	8.27	9.14	20	8	600	3	6.5
MMSZ5239BT1	F4	9.1	8.65	9.56	20	10	600	3	7
<b>MMSZ5240BT1</b>	F5	10	9.50	10.50	20	17	600	3	8
MMSZ5241BT1	H1	11	10.45	11.55	20	22	600	2	8.4
<b>MMSZ5242BT1</b>	H2	12	11.40	12.60	20	30	600	1	9.1
MMSZ5243BT1	H3	13	12.35	13.65	9.5	13	600	0.5	9.9
MMSZ5244BT1	H4	14	13.30	14.70	9.0	15	600	0.1	10
<b>MMSZ5245BT1</b>	H5	15	14.25	15.75	8.5	16	600	0.1	11
<b>MMSZ5246BT1</b>	J1	16	15.20	16.80	7.8	17	600	0.1	12
MMSZ5247BT1	J2	17	16.15	17.85	7.4	19	600	0.1	13
<b>MMSZ5248BT1</b>	J3	18	17.10	18.90	7.0	21	600	0.1	14
MMSZ5249BT1	J4	19	18.05	19.95	6.6	23	600	0.1	14
MMSZ5250BT1	J5	20	19.00	21.00	6.2	25	600	0.1	15
MMSZ5251BT1	K1	22	20.90	23.10	5.6	29	600	0.1	17
<b>MMSZ5252BT1</b>	K2	24	22.80	25.20	5.2	33	600	0.1	18
MMSZ5253BT1	K3	25	23.75	26.25	5.0	35	600	0.1	19
MMSZ5254BT1	K4	27	25.65	28.35	4.6	41	600	0.1	21
MMSZ5255BT1	K5	28	26.60	29.40	4.5	44	600	0.1	21

[1] Nominal zener voltage is measured with the device junction in thermal equilibrium at  $T_L = 30^\circ\text{C} \pm 1^\circ\text{C}$ .

[2] All part numbers shown indicate a  $V_Z$  tolerance of  $\pm 5\%$ .

[3]  $Z_{ZT}$  and  $Z_{ZK}$  are measured by dividing the AC voltage drop across the device by the AC current applied. The specified limits are for  $I_{Z(AC)} = 0.1 I_{Z(DC)}$ , with the AC frequency = 1 kHz.

# MMSZ5221BT1, MMSZ4678T1, MMSZ2V4T1 Series

**ELECTRICAL CHARACTERISTICS** ( $T_A = 25^\circ\text{C}$  unless otherwise noted <sup>[1]</sup>), ( $V_F = 0.9\text{ V Max. @ } I_F = 10\text{ mA}$  for all types)

Type Number	Marking	Zener Voltage $V_Z @ I_{ZT}$ Volts [1] [2]			Test Current $I_{ZT}$ mA	Max Zener Impedance [3]		Max Reverse Leakage Current $I_R @ V_R$ $\mu\text{A}$	Test Voltage $V_R$ Volts
		Nom	Min	Max		$Z_{ZT} @ I_Z = I_{ZT}$ $\Omega$	$Z_{ZK} @ I_{ZK} = 0.25\text{ mA}$ $\Omega$		
<b>MMSZ5256BT1</b>	M1	30	28.50	31.50	4.2	49	600	0.1	23
MMSZ5257BT1	M2	33	31.35	34.65	3.8	58	700	0.1	25
MMSZ5258BT1	M3	36	34.20	37.80	3.4	70	700	0.1	27
MMSZ5259BT1	M4	39	37.05	40.95	3.2	80	800	0.1	30
MMSZ5260BT1	M5	43	40.85	45.15	3.0	93	900	0.1	33
<b>MMSZ5261BT1</b>	N1	47	44.65	49.35	2.7	105	1000	0.1	36
MMSZ5262BT1	N2	51	48.45	53.55	2.5	125	1100	0.1	39
MMSZ5263BT1	N3	56	53.20	58.80	2.2	150	1300	0.1	43
MMSZ5264BT1	N4	60	57.00	63.00	2.1	170	1400	0.1	46
MMSZ5265BT1	N5	62	58.90	65.10	2.0	185	1400	0.1	47
MMSZ5266BT1	P1	68	64.60	71.40	1.8	230	1600	0.1	52
MMSZ5267BT1	P2	75	71.25	78.75	1.7	270	1700	0.1	56
MMSZ5268BT1	P3	82	77.90	86.10	1.5	330	2000	0.1	62
MMSZ5269BT1	P4	87	82.65	91.35	1.4	370	2200	0.1	68
MMSZ5270BT1	P5	91	86.45	95.55	1.4	400	2300	0.1	69

<sup>[1]</sup> Nominal zener voltage is measured with the device junction in thermal equilibrium at  $T_L = 30^\circ\text{C} \pm 1^\circ\text{C}$ .

<sup>[2]</sup> All part numbers shown indicate a  $V_Z$  tolerance of  $\pm 5\%$ .

<sup>[3]</sup>  $Z_{ZT}$  and  $Z_{ZK}$  are measured by dividing the AC voltage drop across the device by the AC current applied. The specified limits are for  $I_{Z(AC)} = 0.1 I_{Z(DC)}$ , with the AC frequency = 1 kHz.

# MMSZ5221BT1, MMSZ4678T1, MMSZ2V4T1 Series

**ELECTRICAL CHARACTERISTICS** ( $T_A = 25^\circ\text{C}$  unless otherwise noted [1], ( $V_F = 0.9\text{ V Max. @ } I_F = 10\text{ mA}$  for all types)

Type Number	Marking	Zener Voltage $V_Z @ I_{ZT} = 50\ \mu\text{A}$ Volts [1] [2]			Max Reverse Leakage Current $I_R @ V_R$ $\mu\text{A}$	Test Voltage $V_R$ Volts
		Nom	Min	Max		
MMSZ4678T1	CC	1.8	1.71	1.89	7.5	1
MMSZ4679T1	CD	2.0	1.90	2.10	5	1
<b>MMSZ4680T1</b>	CE	2.2	2.09	2.31	4	1
MMSZ4681T1	CF	2.4	2.28	2.52	2	1
MMSZ4682T1	CH	2.7	2.57	2.84	1	1
MMSZ4683T1	CJ	3.0	2.85	3.15	0.8	1
MMSZ4684T1	CK	3.3	3.14	3.47	7.5	1.5
<b>MMSZ4685T1</b>	CM	3.6	3.42	3.78	7.5	2
MMSZ4686T1	CN	3.9	3.71	4.10	5	2
MMSZ4687T1	CP	4.3	4.09	4.52	4	2
MMSZ4688T1	CT	4.7	4.47	4.94	10	3
MMSZ4689T1	CU	5.1	4.85	5.36	10	3
<b>MMSZ4690T1</b>	CV	5.6	5.32	5.88	10	4
MMSZ4691T1	CA	6.2	5.89	6.51	10	5
MMSZ4692T1	CX	6.8	6.46	7.14	10	5.1
MMSZ4693T1	CY	7.5	7.13	7.88	10	5.7
MMSZ4694T1	CZ	8.2	7.79	8.61	1	6.2
MMSZ4695T1	DC	8.7	8.27	9.14	1	6.6
MMSZ4696T1	DD	9.1	8.65	9.56	1	6.9
MMSZ4697T1	DE	10	9.50	10.50	1	7.6
MMSZ4698T1	DF	11	10.45	11.55	0.05	8.4
MMSZ4699T1	DH	12	11.40	12.60	0.05	9.1
MMSZ4700T1	DJ	13	12.35	13.65	0.05	9.8
MMSZ4701T1	DK	14	13.30	14.70	0.05	10.6
MMSZ4702T1	DM	15	14.25	15.75	0.05	11.4
MMSZ4703T1	DN	16	15.20	16.80	0.05	12.1
MMSZ4704T1	DP	17	16.15	17.85	0.05	12.9
MMSZ4705T1	DT	18	17.10	18.90	0.05	13.6
MMSZ4706T1	DU	19	18.05	19.95	0.05	14.4
MMSZ4707T1	DV	20	19.00	21.00	0.01	15.2
MMSZ4708T1	DA	22	20.90	23.10	0.01	16.7
MMSZ4709T1	DZ	24	22.80	25.20	0.01	18.2
MMSZ4710T1	DY	25	23.75	26.25	0.01	19.00
MMSZ4711T1	EA	27	25.65	28.35	0.01	20.4
MMSZ4712T1	EC	28	26.60	29.40	0.01	21.2
MMSZ4713T1	ED	30	28.50	31.50	0.01	22.8
MMSZ4714T1	EE	33	31.35	34.65	0.01	25.0
MMSZ4715T1	EF	36	34.20	37.80	0.01	27.3
MMSZ4716T1	EH	39	37.05	40.95	0.01	29.6
MMSZ4717T1	EJ	43	40.85	45.15	0.01	32.6

[1] Nominal zener voltage is measured with the device junction in thermal equilibrium at  $T_L = 30^\circ\text{C} \pm 1^\circ\text{C}$ .

[2] All part numbers shown indicate a  $V_Z$  tolerance of  $\pm 5\%$

# MMSZ5221BT1, MMSZ4678T1, MMSZ2V4T1 Series

**ELECTRICAL CHARACTERISTICS** ( $T_A = 25^\circ\text{C}$  unless otherwise noted), ( $V_F = 0.9\text{ V Max.}$  @  $I_F = 10\text{ mA}$  for all types)

Type Number	Marking	Zener Voltage $V_{Z1}$ (Volts) @ $I_{ZT1} = 5\text{ mA}$ [1][2]			Max Zener Impedance $Z_{ZT1}$ @ $I_{ZT1} = 5\text{ mA}$ [3] $\Omega$	Max Reverse Leakage Current		Zener Voltage $V_{Z2}$ (Volts) @ $I_{ZT2} = 1\text{ mA}$ [1]		Max Zener Impedance $Z_{ZT2}$ @ $I_{ZT1} = 1\text{ mA}$ [3] $\Omega$
		Nom	Min	Max		$I_R$ $\mu\text{A}$	@ $V_R$ Volts	Min	Max	
MMSZ2V4T1	T1	2.4	2.28	2.52	100	50	1	1.7	2.1	600
MMSZ2V7T1	T2	2.7	2.57	2.84	100	20	1	1.9	2.4	600
MMSZ3V0T1	T3	3.0	2.85	3.15	95	10	1	2.1	2.7	600
MMSZ3V3T1	T4	3.3	3.14	3.47	95	5	1	2.3	2.9	600
MMSZ3V6T1	T5	3.6	3.42	3.78	90	5	1	2.7	3.3	600
MMSZ3V9T1	U1	3.9	3.71	4.10	90	3	1	2.9	3.5	600
MMSZ4V3T1	U2	4.3	4.09	4.52	90	3	1	3.3	4.0	600
MMSZ4V7T1	U3	4.7	4.47	4.94	80	3	2	3.7	4.7	500
<b>MMSZ5V1T1</b>	U4	5.1	4.85	5.36	60	2	2	4.2	5.3	480
<b>MMSZ5V6T1</b>	U5	5.6	5.32	5.88	40	1	2	4.8	6.0	400
<b>MMSZ6V2T1</b>	V1	6.2	5.89	6.51	10	3	4	5.6	6.6	150
MMSZ6V8T1	V2	6.8	6.46	7.14	15	2	4	6.3	7.2	80
MMSZ7V5T1	V3	7.5	7.13	7.88	15	1	5	6.9	7.9	80
MMSZ8V2T1	V4	8.2	7.79	8.61	15	0.7	5	7.6	8.7	80
MMSZ9V1T1	V5	9.1	8.65	9.56	15	0.5	6	8.4	9.6	100
MMSZ10T1	A1	10	9.50	10.50	20	0.2	7	9.3	10.6	150
MMSZ11T1	A2	11	10.45	11.55	20	0.1	8	10.2	11.6	150
MMSZ12T1	A3	12	11.40	12.60	25	0.1	8	11.2	12.7	150
MMSZ13T1	A4	13	12.35	13.65	30	0.1	8	12.3	14.0	170
MMSZ15T1	A5	15	14.25	15.75	30	0.05	10.5	13.7	15.5	200
MMSZ16T1	X1	16	15.20	16.80	40	0.05	11.2	15.2	17.0	200
<b>MMSZ18T1</b>	X2	18	17.10	18.90	45	0.05	12.6	16.7	19.0	225
MMSZ20T1	X3	20	19.00	21.00	55	0.05	14	18.7	21.1	225
MMSZ22T1	X4	22	20.80	23.10	55	0.05	15.4	20.7	23.2	250
MMSZ24T1	X5	24	22.80	25.20	70	0.05	16.8	22.7	25.5	250

Type Number	Marking	Zener Voltage $V_{Z1}$ (Volts) @ $I_{ZT1} = 2\text{ mA}$ [1][2]			Max Zener Impedance $Z_{ZT1}$ @ $I_{ZT1} = 2\text{ mA}$ [3] $\Omega$	Max Reverse Leakage Current		Zener Voltage $V_{Z2}$ (Volts) @ $I_{ZT2} = 0.1\text{ mA}$ [1]		Max Zener Impedance $Z_{ZT2}$ @ $I_{ZT1} = 0.5\text{ mA}$ [3][4] $\Omega$
		Nom	Min	Max		$I_R$ $\mu\text{A}$	@ $V_R$ Volts	Min	Max	
MMSZ27T1	Y1	27	25.65	28.35	80	0.05	18.9	25	28.9	300
MMSZ30T1	Y2	30	28.50	31.50	80	0.05	21	27.8	32	300
MMSZ33T1	Y3	33	31.35	34.65	80	0.05	23.1	30.8	35	325
MMSZ36T1	Y4	36	34.20	37.80	90	0.05	25.2	33.8	38	350
<b>MMSZ39T1</b>	Y5	39	37.05	40.95	130	0.05	27.3	36.7	41	350
MMSZ43T1	Z1	43	40.85	45.15	150	0.05	30.1	39.7	46	375
MMSZ47T1	Z2	47	44.65	49.35	170	0.05	32.9	43.7	50	375
MMSZ51T1	Z3	51	48.45	53.55	180	0.05	35.7	47.6	54	400
MMSZ56T1	Z4	56	53.20	58.80	200	0.05	39.2	51.5	60	425
MMSZ62T1	Z5	62	58.90	65.10	215	0.05	43.4	57.4	66	450
MMSZ68T1	Z6	68	64.60	71.40	240	0.05	47.6	63.4	72	475
MMSZ75T1	Z7	75	71.25	78.75	255	0.05	52.5	69.4	79	500

[1] Zener voltage is measured with the zener current applied for  $PW = 1.0\text{ ms}$ .

[2] All part numbers shown indicate a  $V_Z$  tolerance of  $\pm 5\%$ .

[3]  $Z_{ZT1}$  and  $Z_{ZT2}$  are measured by dividing the AC voltage drop across the device by the AC current applied. The specified limits are for  $I_{Z(AC)} = 0.1 I_{Z(DC)}$ , with the AC frequency = 1 kHz.

[4] The zener impedance,  $Z_{ZT2}$ , for the 27 through 75 volt types is tested at 0.5 mA rather than the test current of 0.1 mA used for  $V_{Z2}$ .

# MMSZ5221BT1, MMSZ4678T1, MMSZ2V4T1 Series

## INFORMATION FOR USING THE SOD-123 SURFACE MOUNT PACKAGE

### MINIMUM RECOMMENDED FOOTPRINTS FOR SURFACE MOUNT APPLICATIONS

Surface mount board layout is a critical portion of the total design. The footprint for the semiconductor packages must be the correct size to ensure proper solder connection interface between the board and the package.

The minimum recommended footprint for the SOD-123 is shown at the right.

The SOD-123 package can be used on existing surface mount boards which have been designed for the leadless 34 package style. The footprint compatibility makes conversion from leadless 34 to SOD-123 straightforward.

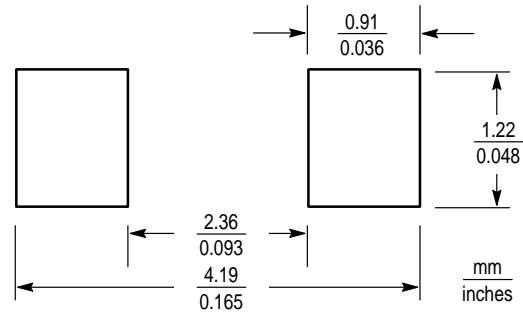

Figure 11. Minimum Recommended Footprint

### SOD-123 POWER DISSIPATION

The power dissipation of the SOD-123 is a function of the pad size. This can vary from the minimum pad size for soldering to a pad size given for maximum power dissipation. Power dissipation for a surface mount device is determined by  $T_{J(max)}$ , the maximum rated junction temperature of the die,  $R_{\theta JA}$ , the thermal resistance from the device junction to ambient; and the operating temperature,  $T_A$ . Using the values provided on the data sheet for the SOD-123 package,  $P_D$  can be calculated as follows:

$$P_D = \frac{T_{J(max)} - T_A}{R_{\theta JA}}$$

The values for the equation are found in the maximum

ratings table on the data sheet. Substituting these values into the equation for an ambient temperature  $T_A$  of 25°C, one can calculate the power dissipation of the device which in this case is 0.37 watts.

$$P_D = \frac{150^\circ\text{C} - 25^\circ\text{C}}{340^\circ\text{C/W}} = 0.37 \text{ watts}$$

The 340°C/W for the SOD-123 package assumes using recommended footprint shown on FR-4 glass epoxy printed circuit board. Another alternative is to use a ceramic substrate or an aluminum core board such as Thermal Clad™. By using an aluminum core board material such as Thermal Clad, the power dissipation can be doubled using the same footprint.

### GENERAL SOLDERING PRECAUTIONS

The melting temperature of solder is higher than the rated temperature of the device. When the entire device is heated to a high temperature, failure to complete soldering within a short time could result in device failure. Therefore, the following items should always be observed in order to minimize the thermal stress to which the devices are subjected.

- Always preheat the device.
- The delta temperature between the preheat and soldering should be 100°C or less.\*
- When preheating and soldering, the temperature of the leads and the case must not exceed the maximum temperature ratings as shown on the data sheet. When using infrared heating with the reflow soldering method, the difference shall be a maximum of 10°C.

- The soldering temperature and time shall not exceed 260°C for more than 10 seconds.
- When shifting from preheating to soldering, the maximum temperature gradient shall be 5°C or less.
- After soldering has been completed, the device should be allowed to cool naturally for at least three minutes. Gradual cooling should be used as the use of forced cooling will increase the temperature gradient and result in latent failure due to mechanical stress.
- Mechanical stress or shock should not be applied during cooling

\* Soldering a device without preheating can cause excessive thermal shock and stress which can result in damage to the device.

# Zener Voltage Regulator Diodes — Surface Mounted

## 500 mW SOD-123

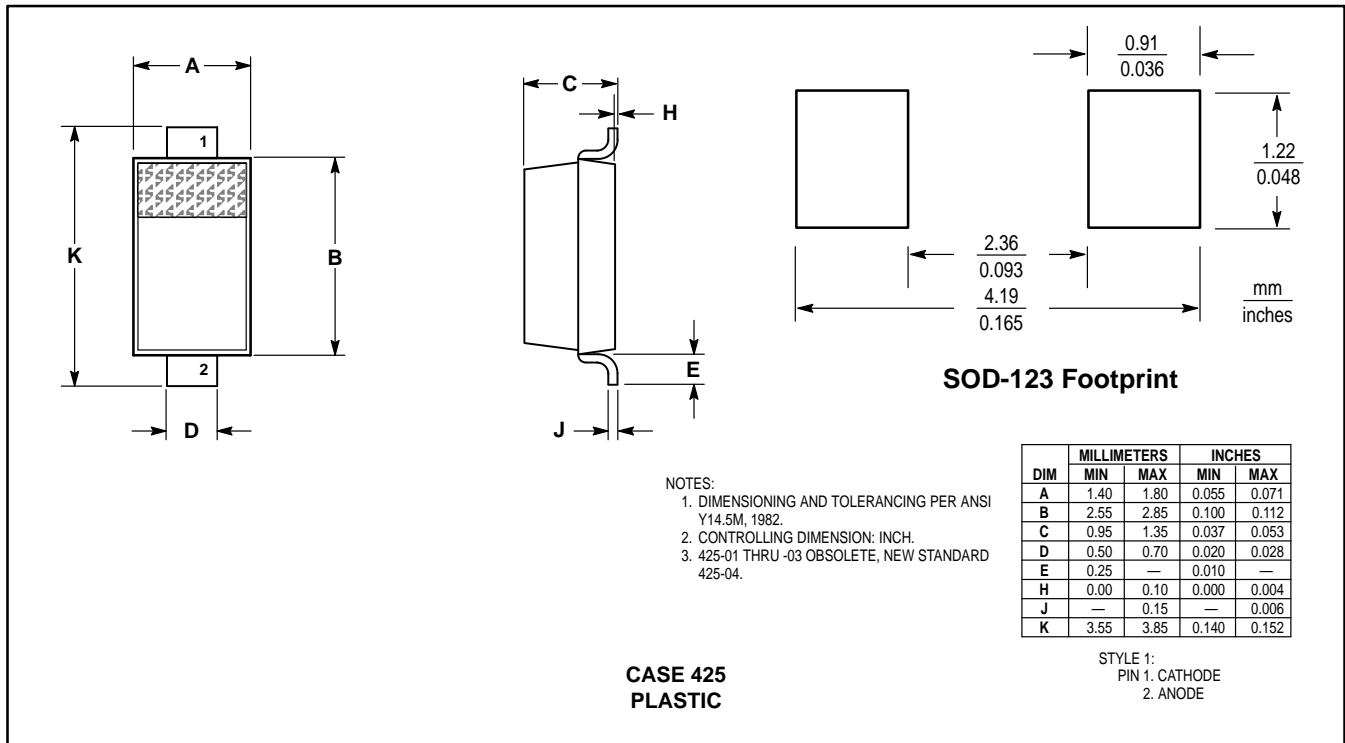

(Refer to Section 10 for Surface Mount, Thermal Data and Footprint Information.)

### MULTIPLE PACKAGE QUANTITY (MPQ) REQUIREMENTS

Package Option	Type No. Suffix	MPQ (Units)
Tape and Reel	T1(1)	3K
Tape and Reel	T3(2)	10K

NOTE: 1. The numbers on the suffixes indicate the following:

1. 7" Reel. Cathode lead toward sprocket hole.
2. 13" Reel. Cathode lead toward sprocket hole.

(Refer to Section 10 for more information on Packaging Specifications.)

## 3 Watt Plastic Surface Mount Silicon Zener Diodes

**1SMB5913BT3  
through  
1SMB5956BT3**

This complete new line of 3 Watt Zener Diodes offers the following advantages.

### Specification Features:

- A Complete Voltage Range — 3.3 to 200 Volts
- Flat Handling Surface for Accurate Placement
- Package Design for Top Side or Bottom Circuit Board Mounting
- Available in Tape and Reel

### Mechanical Characteristics:

**CASE:** Void-free, transfer-molded plastic

**MAXIMUM CASE TEMPERATURE FOR SOLDERING PURPOSES:** 260°C for 10 seconds

**FINISH:** All external surfaces are corrosion resistant with readily solderable leads

**POLARITY:** Cathode indicated by molded polarity notch. When operated in zener mode, cathode will be positive with respect to anode.

**MOUNTING POSITION:** Any

**WEIGHT:** Modified L-Bend providing more contact area to bond pad

**WAFER FAB LOCATION:** Phoenix, Arizona

**ASSEMBLY/TEST LOCATION:** Seremban, Malaysia

**PLASTIC SURFACE MOUNT  
ZENER DIODES  
3 WATTS  
3.3–200 VOLTS**



**CASE 403A  
PLASTIC**

### MAXIMUM RATINGS

Rating	Symbol	Value	Unit
DC Power Dissipation @ $T_L = 75^\circ\text{C}$ , Measured at Zero Lead Length Derate above 75°C	$P_D$	3 40	Watts mW/°C
DC Power Dissipation @ $T_A = 25^\circ\text{C}^*$ Derate above 25°C	$P_D$	830 6.6	mW mW/°C
Operating and Storage Junction Temperature Range	$T_J, T_{stg}$	- 65 to +150	°C

\*FR4 Board, within 1" to device, using Motorola minimum recommended footprint, as shown in case 403A outline dimensions spec.

### ELECTRICAL CHARACTERISTICS ( $T_L = 30^\circ\text{C}$ unless otherwise noted.) ( $V_F = 1.5$ Volts Max @ $I_F = 200$ mAdc for all types.)

Device*	Nominal Zener Voltage $V_Z$ @ $I_{ZT}$ Volts (Note 1)	Test Current $I_{ZT}$ mA	Max Zener Impedance (Note 2)			Max Reverse Leakage Current		Maximum DC Zener Current $I_{ZM}$ mAdc	Device Marking
			$Z_{ZT}$ @ $I_{ZT}$ Ohms	$Z_{ZK}$ Ohms @	$I_{ZK}$ mA	$I_R$ @ $V_R$ $\mu\text{A}$ Volts			
1SMB5913BT3	3.3	113.6	10	500	1	100	1	454	913B
1SMB5914BT3	3.6	104.2	9	500	1	75	1	416	914B
<b>1SMB5915BT3</b>	<b>3.9</b>	<b>96.1</b>	<b>7.5</b>	<b>500</b>	<b>1</b>	<b>25</b>	<b>1</b>	<b>384</b>	<b>915B</b>
<b>1SMB5916BT3</b>	<b>4.3</b>	<b>87.2</b>	<b>6</b>	<b>500</b>	<b>1</b>	<b>5</b>	<b>1</b>	<b>348</b>	<b>916B</b>
<b>1SMB5917BT3</b>	<b>4.7</b>	<b>79.8</b>	<b>5</b>	<b>500</b>	<b>1</b>	<b>5</b>	<b>1.5</b>	<b>319</b>	<b>917B</b>
<b>1SMB5918BT3</b>	<b>5.1</b>	<b>73.5</b>	<b>4</b>	<b>350</b>	<b>1</b>	<b>5</b>	<b>2</b>	<b>294</b>	<b>918B</b>
<b>1SMB5919BT3</b>	<b>5.6</b>	<b>66.9</b>	<b>2</b>	<b>250</b>	<b>1</b>	<b>5</b>	<b>3</b>	<b>267</b>	<b>919B</b>
<b>1SMB5920BT3</b>	<b>6.2</b>	<b>60.5</b>	<b>2</b>	<b>200</b>	<b>1</b>	<b>5</b>	<b>4</b>	<b>241</b>	<b>920B</b>
1SMB5921BT3	6.8	55.1	2.5	200	1	5	5.2	220	921B
1SMB5922BT3	7.5	50	3	400	0.5	5	6.8	200	922B
<b>1SMB5923BT3</b>	<b>8.2</b>	<b>45.7</b>	<b>3.5</b>	<b>400</b>	<b>0.5</b>	<b>5</b>	<b>6.5</b>	<b>182</b>	<b>923B</b>
1SMB5924BT3	9.1	41.2	4	500	0.5	5	7	164	924B
<b>1SMB5925BT3</b>	<b>10</b>	<b>37.5</b>	<b>4.5</b>	<b>500</b>	<b>0.25</b>	<b>5</b>	<b>8</b>	<b>150</b>	<b>925B</b>
<b>1SMB5926BT3</b>	<b>11</b>	<b>34.1</b>	<b>5.5</b>	<b>550</b>	<b>0.25</b>	<b>1</b>	<b>8.4</b>	<b>136</b>	<b>926B</b>
<b>1SMB5927BT3</b>	<b>12</b>	<b>31.2</b>	<b>6.5</b>	<b>550</b>	<b>0.25</b>	<b>1</b>	<b>9.1</b>	<b>125</b>	<b>927B</b>
1SMB5928BT3	13	28.8	7	550	0.25	1	9.9	115	928B

(continued)

\*TOLERANCE AND VOLTAGE DESIGNATION Tolerance designation — The type numbers listed indicate a tolerance of  $\pm 5\%$ .

Devices listed in bold, italic are Motorola preferred devices.



# 1SMB5913BT3 Series

**ELECTRICAL CHARACTERISTICS — continued** ( $T_L = 30^\circ\text{C}$  unless otherwise noted.) ( $V_F = 1.5$  Volts Max @  $I_F = 200$  mAdc for all types.)

Device*	Nominal Zener Voltage $V_Z$ @ $I_{ZT}$ Volts (Note 1)	Test Current $I_{ZT}$ mA	Max Zener Impedance (Note 2)			Max Reverse Leakage Current		Maximum DC Zener Current $I_{ZM}$ mAdc	Device Marking
			$Z_{ZT}$ @ $I_{ZT}$ Ohms	$Z_{ZK}$ @ $I_{ZK}$ Ohms	$I_{ZK}$ mA	$I_R$ @ $V_R$ $\mu\text{A}$ Volts			
<b>1SMB5929BT3</b>	<b>15</b>	<b>25</b>	<b>9</b>	<b>600</b>	<b>0.25</b>	<b>1</b>	<b>11.4</b>	<b>100</b>	<b>929B</b>
1SMB5930BT3	16	23.4	10	600	0.25	1	12.2	93	930B
<b>1SMB5931BT3</b>	<b>18</b>	<b>20.8</b>	<b>12</b>	<b>650</b>	<b>0.25</b>	<b>1</b>	<b>13.7</b>	<b>83</b>	<b>931B</b>
1SMB5932BT3	20	18.7	14	650	0.25	1	15.2	75	932B
1SMB5933BT3	22	17	17.5	650	0.25	1	16.7	68	933B
<b>1SMB5934BT3</b>	<b>24</b>	<b>15.6</b>	<b>19</b>	<b>700</b>	<b>0.25</b>	<b>1</b>	<b>18.2</b>	<b>62</b>	<b>934B</b>
<b>1SMB5935BT3</b>	<b>27</b>	<b>13.9</b>	<b>23</b>	<b>700</b>	<b>0.25</b>	<b>1</b>	<b>20.6</b>	<b>55</b>	<b>935B</b>
<b>1SMB5936BT3</b>	<b>30</b>	<b>12.5</b>	<b>26</b>	<b>750</b>	<b>0.25</b>	<b>1</b>	<b>22.8</b>	<b>50</b>	<b>936B</b>
1SMB5937BT3	33	11.4	33	800	0.25	1	25.1	45	937B
<b>1SMB5938BT3</b>	<b>36</b>	<b>10.4</b>	<b>38</b>	<b>850</b>	<b>0.25</b>	<b>1</b>	<b>27.4</b>	<b>41</b>	<b>938B</b>
1SMB5939BT3	39	9.6	45	900	0.25	1	29.7	38	939B
1SMB5940BT3	43	8.7	53	950	0.25	1	32.7	34	940B
1SMB5941BT3	47	8	67	1000	0.25	1	35.8	31	941B
1SMB5942BT3	51	7.3	70	1100	0.25	1	38.8	29	942B
1SMB5943BT3	56	6.7	86	1300	0.25	1	42.6	26	943B
1SMB5944BT3	62	6	100	1500	0.25	1	47.1	24	944B
1SMB5945BT3	68	5.5	120	1700	0.25	1	51.7	22	945B
1SMB5946BT3	75	5	140	2000	0.25	1	56	20	946B
1SMB5947BT3	82	4.6	160	2500	0.25	1	62.2	18	947B
1SMB5948BT3	91	4.1	200	3000	0.25	1	69.2	16	948B
<b>1SMB5949BT3</b>	<b>100</b>	<b>3.7</b>	<b>250</b>	<b>3100</b>	<b>0.25</b>	<b>1</b>	<b>76</b>	<b>15</b>	<b>949B</b>
1SMB5950BT3	110	3.4	300	4000	0.25	1	83.6	13	950B
1SMB5951BT3	120	3.1	380	4500	0.25	1	91.2	12	951B
1SMB5952BT3	130	2.9	450	5000	0.25	1	98.8	11	952B
1SMB5953BT3	150	2.5	600	6000	0.25	1	114	10	953B
1SMB5954BT3	160	2.3	700	6500	0.25	1	121.6	9	954B
1SMB5955BT3	180	2.1	900	7000	0.25	1	136.8	8	955B
1SMB5956BT3	200	1.9	1200	8000	0.25	1	152	7	956B

\*TOLERANCE AND VOLTAGE DESIGNATION Tolerance designation — The type numbers listed indicate a tolerance of  $\pm 5\%$ .

Devices listed in bold, italic are Motorola preferred devices.

# 1SMB5913BT3 Series

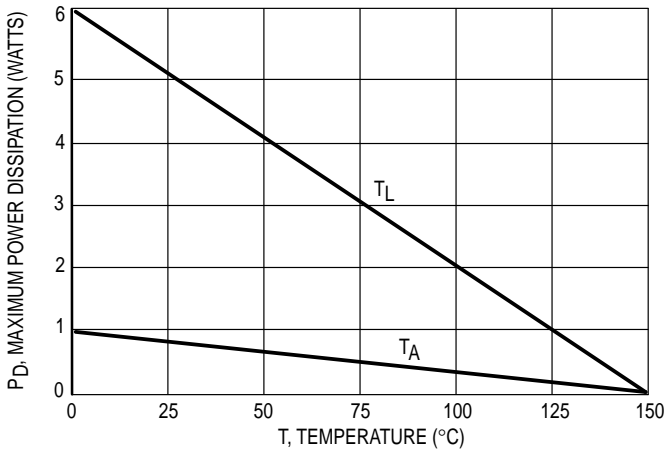

Figure 1. Steady State Power Derating

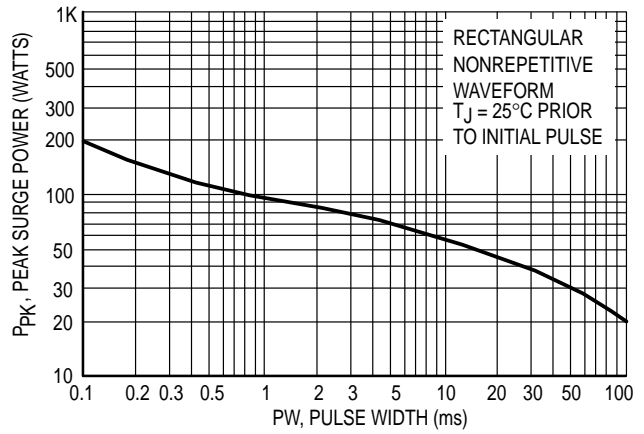

Figure 2. Maximum Surge Power

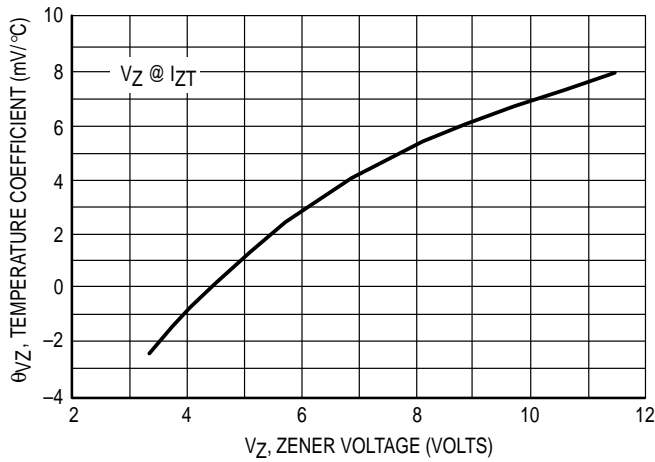

Figure 3. Zener Voltage — To 12 Volts

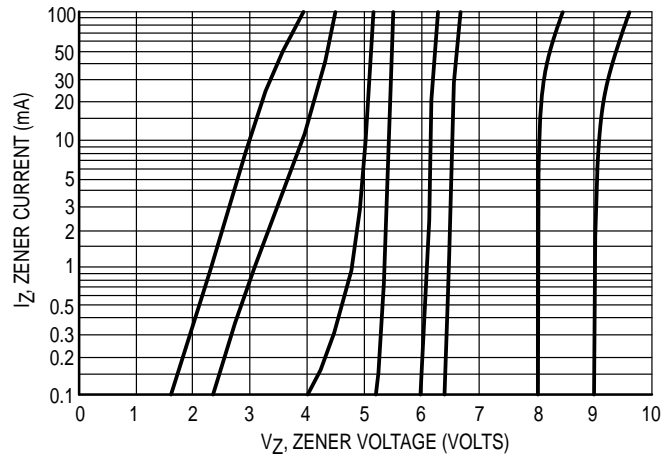

Figure 4. V<sub>Z</sub> = 3.3 thru 10 Volts

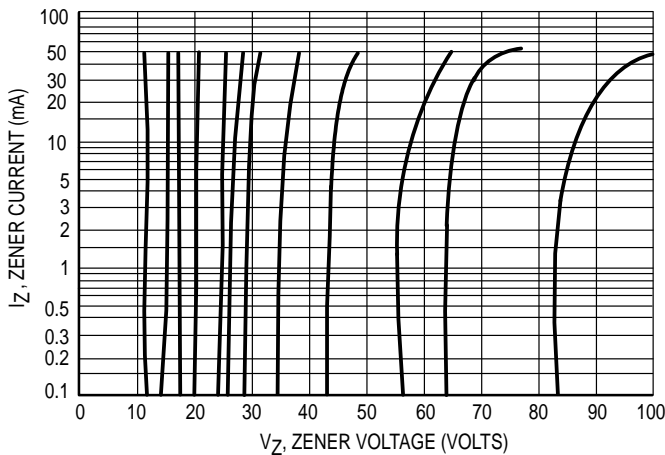

Figure 5. V<sub>Z</sub> = 12 thru 82 Volts

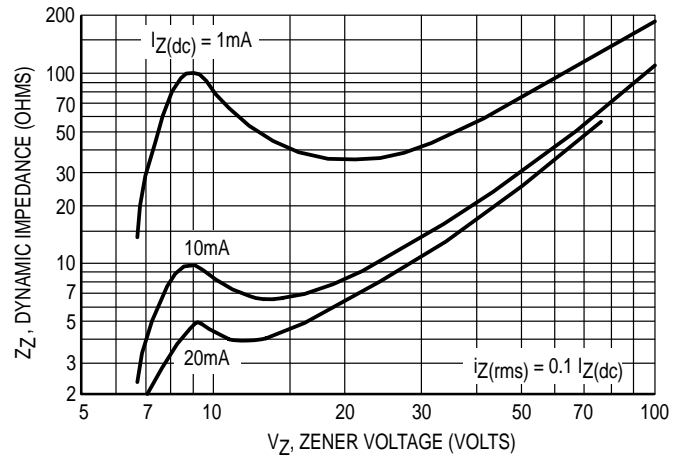

Figure 6. Effect of Zener Voltage

# 1SMB5913BT3 Series

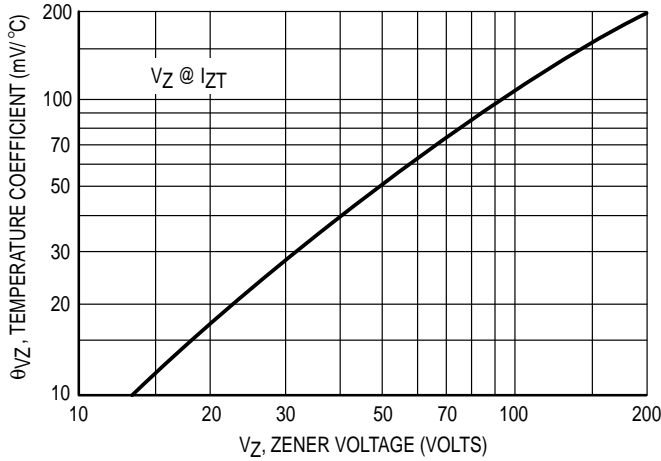

Figure 7. Zener Voltage — 14 To 200 Volts

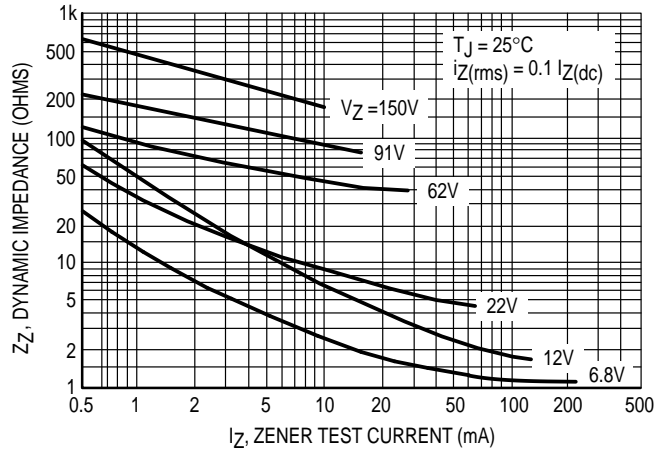

Figure 8. Effect of Zener Current

**NOTE 1. ZENER VOLTAGE ( $V_Z$ ) MEASUREMENT**

Nominal zener voltage is measured with the device junction in thermal equilibrium with ambient temperature at 25°C.

**NOTE 2. ZENER IMPEDANCE ( $Z_Z$ ) DERIVATION**

$Z_{ZT}$  and  $Z_{ZK}$  are measured by dividing the ac voltage drop across the device by the ac current applied. The specified limits are for  $I_Z(ac) = 0.1 I_Z(dc)$  with the ac frequency = 60 Hz.

# Zener Voltage Regulator Diodes — Surface Mounted

## 3 Watt DC Power

NOTES:

1. DIMENSIONING AND TOLERANCING PER ANSI Y14.5M, 1982.
2. CONTROLLING DIMENSION: INCH.
3. D DIMENSION SHALL BE MEASURED WITHIN DIMENSION P.

DIM	INCHES		MILLIMETERS	
	MIN	MAX	MIN	MAX
A	0.160	0.180	4.06	4.57
B	0.130	0.150	3.30	3.81
C	0.075	0.095	1.90	2.41
D	0.077	0.083	1.96	2.11
H	0.0020	0.0060	0.051	0.152
J	0.006	0.012	0.15	0.30
K	0.030	0.050	0.76	1.27
P	0.020	REF	0.51	REF
S	0.205	0.220	5.21	5.59

**SMB Footprint**

**CASE 403A-03  
PLASTIC**

(Refer to Section 10 for Surface Mount, Thermal Data and Footprint Information.)

### MULTIPLE PACKAGE QUANTITY (MPQ) REQUIREMENTS

Package Option	Type No. Suffix	MPQ (Units)
Tape and Reel	T3 (13 inch)	2.5K

(Refer to Section 10 for more information on Packaging Specifications.)