



**DUAL POSITIVE/NEGATIVE,
3 AMP, ULTRA LOW DROPOUT
FIXED VOLTAGE REGULATORS**

**5200
SERIES**

4707 Dey Road Liverpool, N.Y. 13088

(315) 701-6751

FEATURES:

MIL-PRF-38534 QUALIFIED

- Ultra Low Dropout Voltage
- Internal Short Circuit Current Limit
- Output Voltages Are Internally Set To $\pm 1\%$ Maximum
- Electrically Isolated Case
- Internal Thermal Overload Protection
- Many Output Voltage Combinations
- Alternate Package and Lead Form Configurations Available

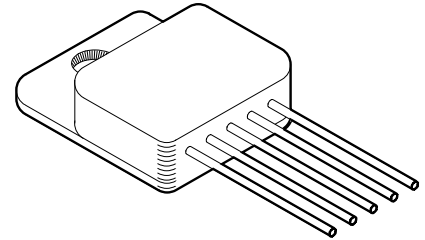

DESCRIPTION:

The MSK 5200 Series offers ultra low dropout voltages on both the positive and negative regulators. This, combined with the low θ_{JC} , allows increased output current while providing exceptional device efficiency. Because of the increased efficiency, a small hermetic 5 pin package can be used providing maximum performance while occupying minimal board space. Output voltages are internally trimmed to $\pm 1\%$ maximum resulting in consistent and accurate operation. Additionally, both regulators offer internal short circuit current and thermal limiting, which allows circuit protection and eliminates the need for external components and excessive derating.

EQUIVALENT SCHEMATIC

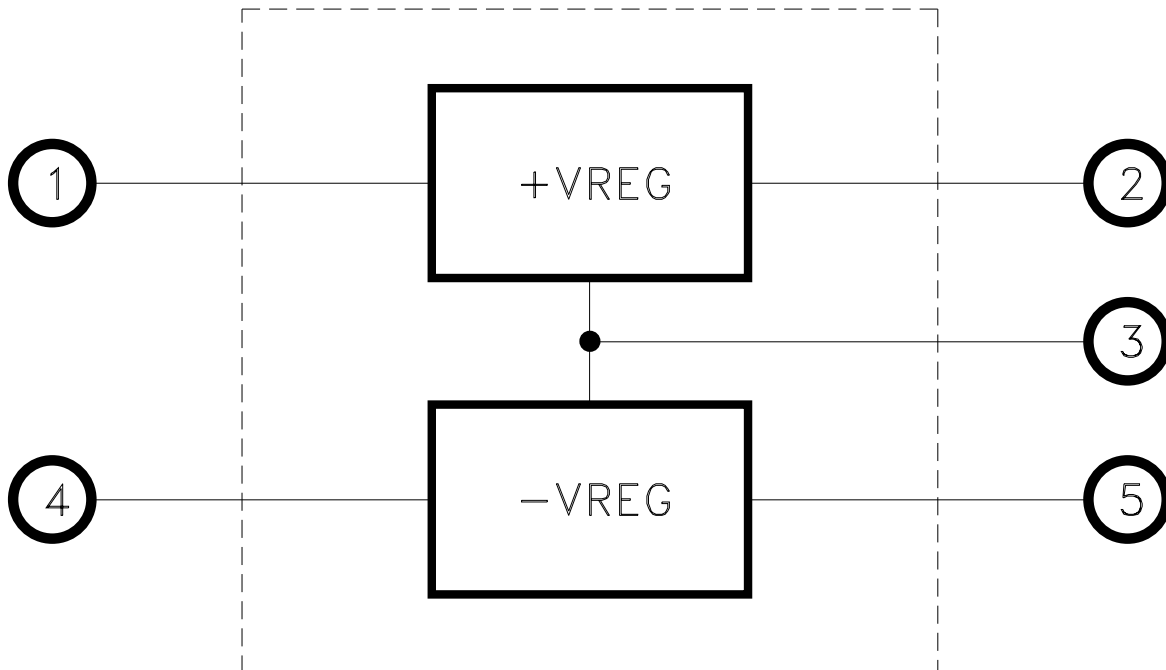

TYPICAL APPLICATIONS

- High Efficiency Linear Regulators
- Constant Voltage/Current Regulators
- System Power Supplies
- Switching Power Supply Post Regulators

PIN-OUT INFORMATION

- 1 +Vin
- 2 +Vout
- 3 GND
- 4 -Vin
- 5 -Vout

ABSOLUTE MAXIMUM RATINGS

$\pm V_{IN}$	Input Voltage	$\pm 26V$	T_{ST}	Storage Temperature Range	$-65^{\circ}C$ to $+150^{\circ}C$
P_D	Power Dissipation	Internally Limited	T_{LD}	Lead Temperature Range	$300^{\circ}C$ (10 Seconds)
I_{OUT}	Output Current	$\pm 3.5A$	T_C	Case Operating Temperature	MSK5200-5210 $-40^{\circ}C$ to $+125^{\circ}C$ MSK5200H-5210H $-55^{\circ}C$ to $+125^{\circ}C$
T_J	Junction Temperature	$+175^{\circ}C$			

ELECTRICAL SPECIFICATIONS

Parameter	Test Conditions ① ③	Group A Subgroup	MSK 5200(H) SERIES			MSK 5200 SERIES			Units
			Min.	Typ.	Max.	Min.	Typ.	Max.	
POSITIVE OUTPUT REGULATORS:									
Output Voltage Tolerance	$V_{IN} = V_{OUT} + 1V$	1	-	0.5	1.0	-	0.5	1.5	%
	$I_{OUT} = 0A$	2,3	-	1.0	2.0	-	1.0	-	%
Dropout Voltage ②	$I_{OUT} = 2A; \Delta V_{OUT} = -1\%$	1	-	350	600	-	350	625	mV
Load Regulation	$100mA \leq I_{OUT} \leq 3A$	1	-	0.2	1.0	-	0.2	1.2	%
	$V_{IN} = V_{OUT} + 1V$	2,3	-	0.3	2.0	-	0.3	-	%
Line Regulation	$I_{OUT} = 0A$	1	-	0.1	0.5	-	0.1	0.6	%
	$(V_{OUT} + 1V) \leq V_{IN} \leq (26V)$	2,3	-	0.5	1.0	-	0.5	-	%
Quiescent Current	$V_{IN} = V_{OUT} + 1V; I_{OUT} = 0A$	1,2,3	-	10	15	-	10	15	mA
Short Circuit Current ②	$V_{IN} = V_{OUT} + 1V$	-	3.2	4.5	5.0	3.0	4.5	5.0	A
Ripple Rejection ②	$I_{OUT} = 3A; C_{OUT} = 25\mu F; f = 120Hz$	-	60	75	-	60	75	-	dB
Thermal Resistance ②	JUNCTION TO CASE	-	-	2.5	2.8	-	2.5	2.8	$^{\circ}C/W$
NEGATIVE OUTPUT REGULA- ⑨									
TORS:									
Output Voltage Tolerance	$V_{IN} = V_{OUT} + 1.5V$	1	-	0.1	1.0	-	0.1	2.0	%
	$I_{OUT} = 0A$	2,3	-	0.1	2.0	-	-	-	%
②	$I_{OUT} = 2A; \Delta V_{OUT} = -1\%$	1	-	550	700	-	550	750	mV
Dropout Voltage	$V_{IN} = V_{OUT} + 1.5V$	1	-	0.3	1.5	-	0.3	1.7	%
Load Regulation	$100mA \leq I_{OUT} \leq 3A$	2,3	-	0.5	2.5	-	0.5	-	%
	$I_{OUT} = 0A$	1	-	0.1	0.5	-	0.1	0.6	%
Line Regulation	$(V_{OUT} + 1.5V) \leq V_{IN} \leq (26V)$	2,3	-	0.5	1.0	-	0.5	-	%
	$V_{IN} = V_{OUT} + 1.5V; I_{OUT} = 0A$	1,2,3	-	4.5	10	-	4.5	10	mA
Quiescent Current ②	$V_{IN} = V_{OUT} + 1V$	-	3.2	3.6	5.0	3.0	3.6	5.0	A
Short Circuit Current ②	$I_{OUT} = 3A; C_{OUT} = 25\mu F; f = 120Hz$	-	60	75	-	60	75	-	dB
Ripple Rejection ②	JUNCTION TO CASE	-	-	2.0	2.4	-	2.0	2.4	$^{\circ}C/W$

Thermal Resistance

PART ⑧ NUMBER	OUTPUT VOLTAGES	
	POSITIVE	NEGATIVE
MSK 5200(H)	+3.3V	-5.2V
MSK 5201(H)	+5.0V	-5.0V
MSK 5202(H)	+5.0V	-5.2V
MSK 5203(H)	+12.0V	-5.0V
MSK 5204(H)	+12.0V	-12.0V
MSK 5205(H)	+15.0V	-15.0V
MSK 5206(H)	+15.0V	-5.0V
MSK 5207(H)	+5.0V	-12.0V
MSK 5208(H)	+5.0V	-15.0V
MSK 5209(H)	+10.0V	-10.0V
MSK 5210(H)	+5.2V	-5.2V

NOTES:

- ① Outputs are decoupled to ground using 20 μF minimum tantalum capacitors unless otherwise specified.
- ② This parameter is guaranteed by design but need not be tested. Typical parameters are representative of actual device performance but are for reference only.
- ③ All output parameters are tested using a low duty cycle pulse to maintain $T_J = T_C$.
- ④ Industrial grade devices shall be tested to subgroups 1 and 4 unless otherwise specified.
- ⑤ Military grade devices ('H' suffix) shall be 100% tested to subgroups 1,2,3 and 4.
- ⑥ Subgroup 5 and 6 testing available upon request.
- ⑦ Subgroup 1,4 $T_C = +25^{\circ}C$
Subgroup 2,5 $T_J = +125^{\circ}C$
Subgroup 3,6 $T_A = -55^{\circ}C$
- ⑧ Please consult the factory if alternate output voltages are required.
- ⑨ Input voltage ($V_{IN} = V_{OUT} +$ a specified voltage) is implied to be more negative than V_{OUT} .

APPLICATION NOTES

BYPASS CAPACITORS:

For most applications a 20uF, tantalum capacitor should be attached as close to the regulator's output as possible. This will effectively lower the regulator's output impedance, improve transient response and eliminate any oscillations that may be normally associated with low dropout regulators. Additional bypass capacitors can be used at the remote load locations to further improve regulation. These can be either of the tantalum or the electrolytic variety. Unless the regulator is located very close to the power supply filter capacitor(s), a 4.7uF minimum tantalum capacitor should also be added to the regulator's input. An electrolytic may also be substituted if desired. When substituting electrolytic in place of tantalum capacitors, a good rule of thumb to follow is to increase the size of the electrolytic by a factor of 10 over the tantalum value.

LOAD REGULATION:

For best results the ground pin should be connected directly to the load as shown below. This effectively reduces the ground loop effect and eliminates excessive voltage drop in the sense leg. It is also important to keep the output connection between the regulator and the load as short as possible since this directly affects the load regulation. If 20 gauge wire were used as an example, which has a resistance of about .008 ohms per foot, this would result in a drop of 8mV/ft at 1Amp of load current. It is also important to follow the capacitor selection guidelines to achieve best performance. Refer to Figure 2 for connection diagram.

MSK 5202 TYPICAL APPLICATION:

Low Dropout Positive and Negative Power Supply

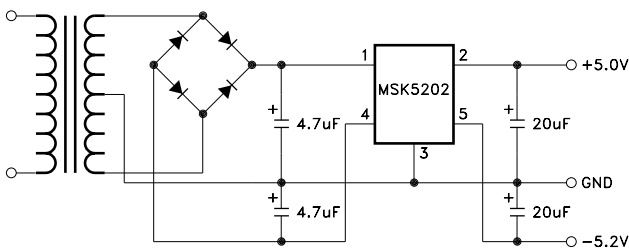

FIGURE 1

Avoiding Ground Loops

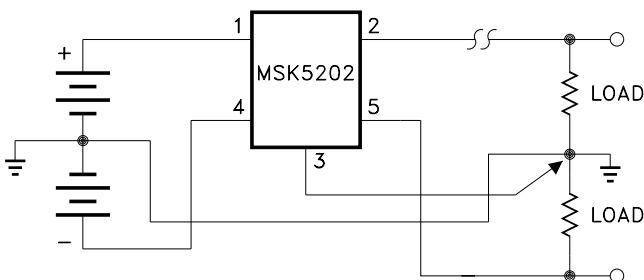

FIGURE 2

OVERLOAD SHUTDOWN:

The regulators feature both current and thermal overload protection. When the maximum power dissipation is not exceeded, the regulators will current limit slightly above their 3 amp rating. As the Vin-Vout voltage increases, however, shutdown occurs in relation to the maximum power dissipation curve. If the device heats enough to exceed its rated die junction temperature due to excessive ambient temperature, improper heat sinking etc., the regulators also shutdown until an appropriate junction temperature is maintained. It should also be noted that in the case of an extreme overload, such as a sustained direct short, the device may not be able to recover. In these instances, the device must be shut off and power reapplied to eliminate the shutdown condition.

HEAT SINKING:

To determine if a heat sink is required for your application and if so, what type, refer to the thermal model and governing equation below.

Governing Equation: $T_j = P_d \times (R_{\theta jc} + R_{\theta cs} + R_{\theta sa}) + T_a$

WHERE

T_j = Junction Temperature
 P_d = Total Power Dissipation
 $R_{\theta jc}$ = Junction to Case Thermal Resistance
 $R_{\theta cs}$ = Case to Heat Sink Thermal Resistance
 $R_{\theta sa}$ = Heat Sink to Ambient Thermal Resistance
 T_c = Case Temperature
 T_a = Ambient Temperature
 T_s = Heat Sink Temperature

EXAMPLE:

This example demonstrates an analysis where each regulator is at one-half of its maximum rated power dissipation, which occurs when the output currents are at 1.5 amps each.

Conditions for MSK 5202:

$V_{in} = \pm 7.0V$; $I_{out} = \pm 1.5A$

- 1.) Assume 45° heat spreading model.
- 2.) Find positive regulator power dissipation:

$$P_d = (V_{in} - V_{out})(I_{out})$$

$$P_d = (7-5)(1.5)$$

$$P_d = 3.0W$$

- 3.) For conservative design, set $T_j = +125^\circ C$ Max.
- 4.) For this example, worst case $T_a = +90^\circ C$.
- 5.) $R_{\theta jc} = 2.5^\circ C/W$ from the Electrical Specification Table.
- 6.) $R_{\theta cs} = 0.15^\circ C/W$ for most thermal greases.
- 7.) Rearrange governing equation to solve for $R_{\theta sa}$:

$$R_{\theta sa} = ((T_j - T_a)/P_d) - (R_{\theta jc}) - (R_{\theta cs})$$

$$= (125^\circ C - 90^\circ C)/3.0W - (2.5^\circ C/W) - (0.15^\circ C/W)$$

$$= 9.15^\circ C/W$$

The same exercise must be performed for the negative regulator. In this case the result is 9.15°C/W. Therefore, a heat sink with a thermal resistance of no more than 9.1°C/W must be used in this application to maintain both regulator circuit junction temperatures under 125°C.

TYPICAL PERFORMANCE CURVES

POSITIVE REGULATORS

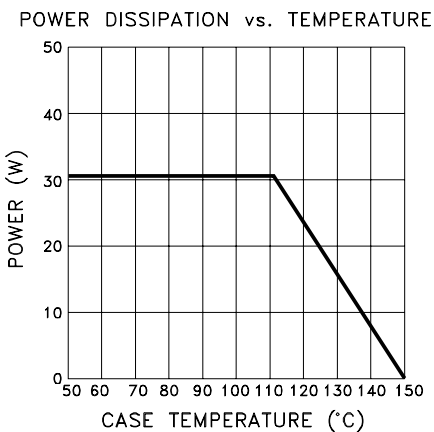
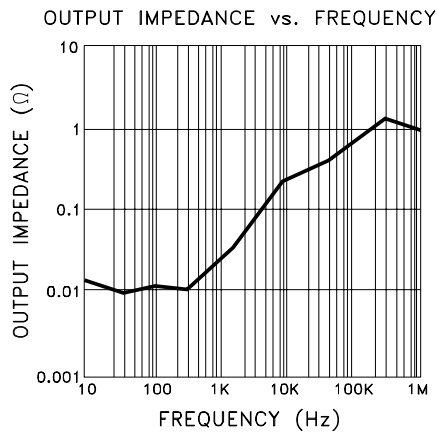
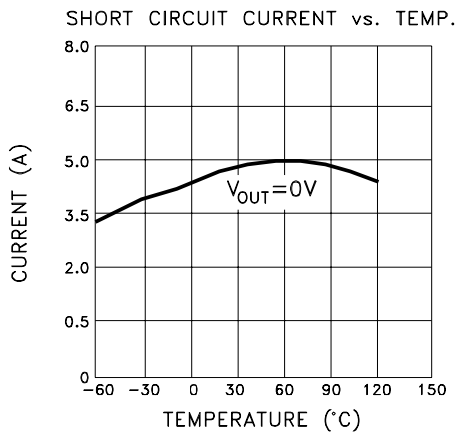
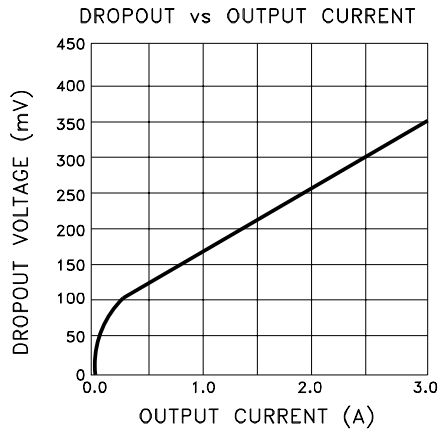

NEGATIVE REGULATORS

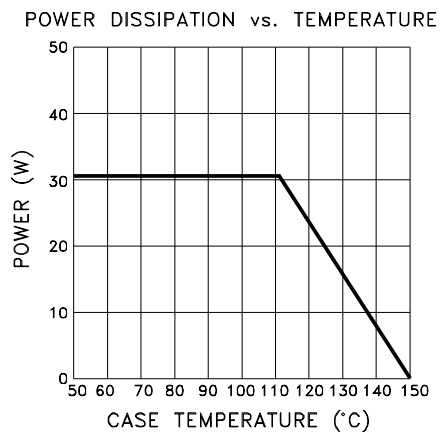
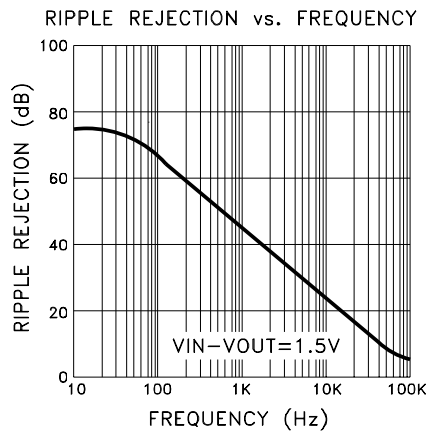
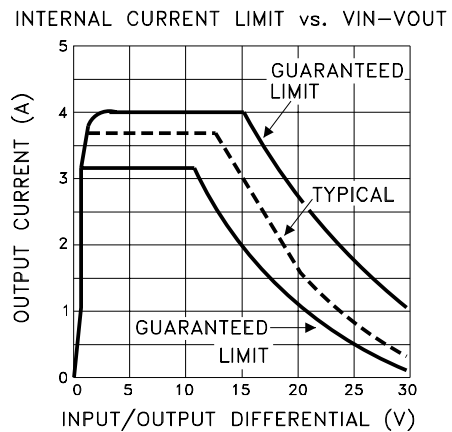
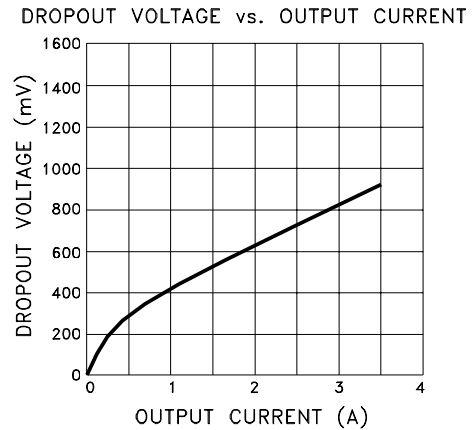

MECHANICAL SPECIFICATIONS

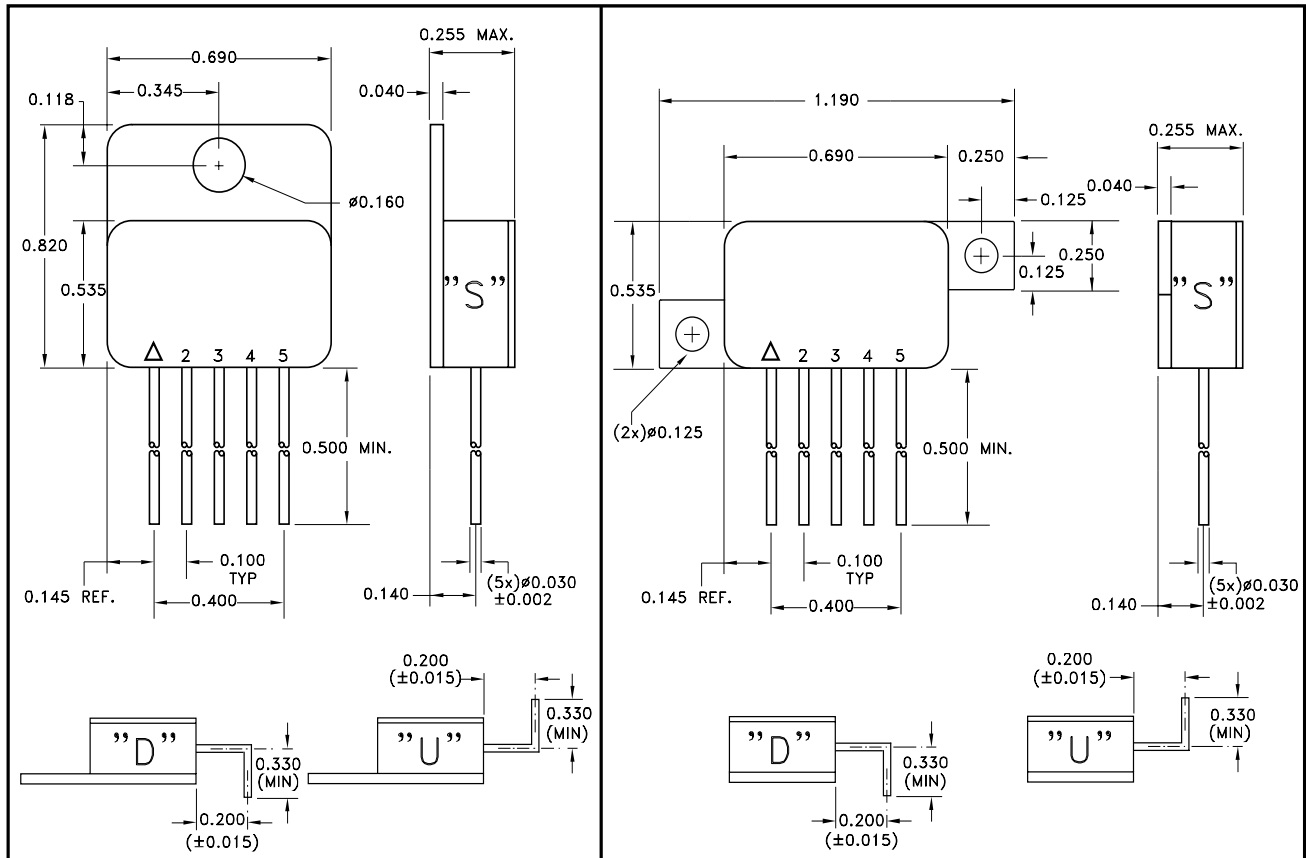

NOTE: ALL DIMENSIONS ARE ± 0.010 INCHES UNLESS OTHERWISE LABELED
ESD Triangle indicates Pin 1.

ORDERING INFORMATION

MSK5200 H T U

LEAD CONFIGURATIONS

S = STRAIGHT; U = BENT UP; D = BENT DOWN

PACKAGE STYLE

T = TOP TAB; Z = Z PACK

SCREENING

BLANK = INDUSTRIAL; H = MIL-PRF-38534

GENERAL PART NUMBER

(VOLTAGE)

THE ABOVE EXAMPLE IS A: +3.3V, -5.2V MILITARY SCREENED REGULATOR USING THE TOP TAB PACKAGE WITH LEADS BENT UP.

M.S. Kennedy Corp.

4707 Dey Road, Liverpool, New York 13088

Phone (315) 701-6751

FAX (315) 701-6752

www.mskennedy.com

The information contained herein is believed to be accurate at the time of printing. MSK reserves the right to make changes to its products or specifications without notice, however, and assumes no liability for the use of its products.