

# NAIS

## HIGH ELECTRICAL & MECHANICAL NOISE IMMUNITY RELAY

# JQ RELAYS

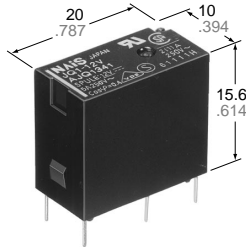

mm inch

### FEATURES

- High electrical noise immunity
- High switching capacity in a compact package
- High sensitivity: 200 mW (1a), 400 mW (1c)
- High surge voltage: 8,000 V between contacts and coil
- UL, CSA, VDE, TÜV, SEMKO approved
- Class B coil insulation type available

### SPECIFICATIONS

#### Contact

		Standard type	High capacity type		
Arrangement		1 Form A, 1 Form C			
Initial contact resistance, max. (By voltage drop 6 V DC 1 A)		100 mΩ			
Contact material		Silver alloy			
Rating (resistive)	Nominal switching capacity	1a	5 A 125 V AC 2 A 250 V AC 5 A 30 V DC	10 A 125 V AC 5 A 250 V AC 5 A 30 V DC	
		1c	N.O.	5 A 125 V AC 2 A 250 V AC 3 A 30 V AC	10 A 125 V AC 5 A 250 V AC 5 A 30 V DC
			N.C.	2 A 125 V AC 1 A 250 V AC 1 A 30 V DC	3 A 125 V AC 2 A 250 V AC 1 A 30 V DC
	Max. switching power	1a	625 VA, 150 W	1,250 VA, 150 W	
		1c	N.O.	625 VA, 90 W	1,250 V AC, 150 W
	N.C.		250 VA, 30 W	500 V AC, 30 W	
Max. switching voltage		250 V AC, 110 V DC (0.3A)			
Max. switching current		N.O.: 5 A N.C.: 2 A	N.O.: 10 A N.C.: 3 A		
Expected mechanical life (at 180 cpm)(min. operations)		10 <sup>7</sup>			

#### Expected electrical life (min. operations)

Type		Switching capacity	No. of operations		
Standard type	1a	5 A 125 V AC	5×10 <sup>4</sup>		
		3 A 125 V AC	2×10 <sup>5</sup>		
		2 A 250 V AC	2×10 <sup>5</sup>		
	1c	5 A 30 V DC	10 <sup>5</sup>		
		1c	N.O.	5 A 125 V AC 2 A 250 V AC 3 A 30 V DC	5×10 <sup>4</sup> 2×10 <sup>5</sup> 10 <sup>5</sup>
N.C.	2 A 125 V AC 1 A 250 V AC 1 A 30 V DC		2×10 <sup>5</sup> 2×10 <sup>5</sup> 10 <sup>5</sup>		
	High capacity type		1a	10 A 125 V AC 5 A 250 V AC 5 A 30 V DC	5×10 <sup>4</sup> 5×10 <sup>4</sup> 10 <sup>5</sup>
1c		N.O.		10 A 125 V AC 5 A 250 V AC 5 A 30 V DC	5×10 <sup>4</sup> 5×10 <sup>4</sup> 10 <sup>5</sup>
		N.C.		3 A 125 V AC 2 A 250 V AC 1 A 30 V DC	2×10 <sup>5</sup> 2×10 <sup>5</sup> 10 <sup>5</sup>

#### Coil (at 20°C 68°F)

Nominal operating power	1a: 200 mW	1c: 400 mW
-------------------------	------------	------------

#### Characteristics

Max. operating speed	20 cpm	
Initial insulation resistance* <sup>1</sup>	Min. 1,000 MΩ at 500 V DC	
Initial breakdown voltage* <sup>2</sup>	Between open contacts	1a: 1,000 Vrms for 1 min. 1c: 750 Vrms for 1 min.
	Between contacts and coil	4,000 Vrms for 1 min.
Surge voltage between contact and coil* <sup>3</sup>	8,000 V	
Operate time* <sup>4</sup> (at nominal voltage)	Approx. 5 ms	
Release time* <sup>4</sup> (at nominal voltage)(without diode)	Approx. 2 ms	
Temperature rise* <sup>5</sup>	Max. 45°C	
Shock resistance	Functional* <sup>6</sup>	Min. 294 m/s <sup>2</sup> {30 G}
	Destructive* <sup>7</sup>	Min. 980 m/s <sup>2</sup> {100 G}
Vibration resistance	Functional* <sup>8</sup>	98 m/s <sup>2</sup> {10 G}, 10 to 55 Hz at double amplitude of 1.6 mm
	Destructive	117.6 m/s <sup>2</sup> {12 G}, 10 to 55 Hz at double amplitude of 2.0 mm
Conditions for operation, transport and storage* <sup>9</sup> (Not freezing and condensing at low temperature)	Ambient temp.* <sup>10</sup>	-40°C to +85°C -40°F to +185°F
	Humidity	5 to 85% R.H.
Unit weight	Approx. 7 g .25 oz	

#### Remarks

- \* Specifications will vary with foreign standards certification ratings.
- \*<sup>1</sup> Measurement at same location as "Initial breakdown voltage" section
- \*<sup>2</sup> Detection current: 10 mA
- \*<sup>3</sup> Wave is standard shock voltage of ±1.2 × 50μs according to JEC-212-1981
- \*<sup>4</sup> Excluding contact bounce time
- \*<sup>5</sup> Measured conditions

Standard type	Resistive, nominal voltage applied to the coil. Contact carrying current: 5 A, at 70°C 158°F
High capacity type	Resistive, nominal voltage applied to the coil. Contact carrying current: 10 A, at 70°C 158°F

\*<sup>6</sup> Half-wave pulse of sine wave: 11 ms; detection time: 10μs

\*<sup>7</sup> Half-wave pulse of sine wave: 6ms

\*<sup>8</sup> Detection time: 10μs

\*<sup>9</sup> Refer to 5. Conditions for operation, transport and storage mentioned in AMBIENT ENVIRONMENT (Page 24).

\*<sup>10</sup> When using relays in a high ambient temperature, consider the pick-up voltage rise due to the high temperature (a rise of approx. 0.4% V for each 1°C 33.8°F with 20°C 68°F as a reference) and use a coil impressed voltage that is within the maximum allowable voltage range.

**TYPICAL APPLICATIONS**

- Air conditioners
- Refrigerators
- Microwave ovens
- Heaters

**ORDERING INFORMATION**

Ex. JQ 1a P — B — 12 V

Contact arrangement	Contact capacity	Coil insulation class	Coil voltage (DC)
1a: 1 Form A 1: 1 Form C	Nil: Standard P: High capacity	Nil: Class E coil insulation B: Class B coil insulation	5, 6, 9, 12, 18, 24, 48* V

UL/CSA, VDE, SEMKO approved type is standard.

\* Available only for 1 Form C type

**TYPES AND COIL DATA at 20°C 68°F**

	Part No.	Nominal voltage, V DC	Pick-up voltage, V DC (min.)	Drop-out voltage, V DC (min.)	Nominal operating current, mA	Nominal operating power, mW	Coil resistance, Ω (±10%)	Max. allowable voltage, V DC	
1 Form A	Standard type	JQ1a-5V	5	3.75	0.25	40	125	180% of nominal voltage (at 20°C 68°F)	
		JQ1a-6V	6	4.5	0.3	33.3	180		
		JQ1a-9V	9	6.75	0.45	22.2	405		
		JQ1a-12V	12	9	0.6	16.7	720		
		JQ1a-18V	18	13.5	0.9	11.1	1,620		
		JQ1a-24V	24	18	1.2	8.3	2,880		
	High capacity type	JQ1aP-5V	5	4	0.25	40	125	130% of nominal voltage (at 85°C 185°F)	
		JQ1aP-6V	6	4.8	0.3	33.3	180		
		JQ1aP-9V	9	7.2	0.45	22.2	405		
		JQ1aP-12V	12	9.6	0.6	16.7	720		
		JQ1aP-18V	18	14.4	0.9	11.1	1,620		
		JQ1aP-24V	24	19.2	1.2	8.3	2,880		
	1 Form C	Standard type	JQ1-5V	5	3.75	0.25	80	62.5	150% of nominal voltage (at 20°C 68°F)
			JQ1-6V	6	4.5	0.3	66.7	90	
JQ1-9V			9	6.75	0.45	44.4	202.5		
JQ1-12V			12	9	0.6	33.3	360		
JQ1-18V			18	13.5	0.9	22.2	810		
JQ1-24V			24	18	1.2	16.7	1,440		
JQ1-48V			48	36	2.4	8.3	5,760		
High capacity type		JQ1P-5V	5	4	0.25	80	62.5	110% of nominal voltage (at 85°C 185°F)	
		JQ1P-6V	6	4.8	0.3	66.7	90		
		JQ1P-9V	9	7.2	0.45	44.4	202.5		
		JQ1P-12V	12	9.6	0.6	33.3	360		
		JQ1P-18V	18	14.4	0.9	22.2	810		
		JQ1P-24V	24	19.2	1.2	16.7	1,440		
		JQ1P-48V	48	38.4	2.4	8.3	5,760		

# DIMENSIONS

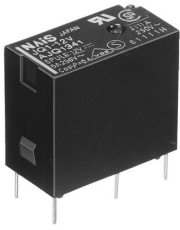

1 Form A

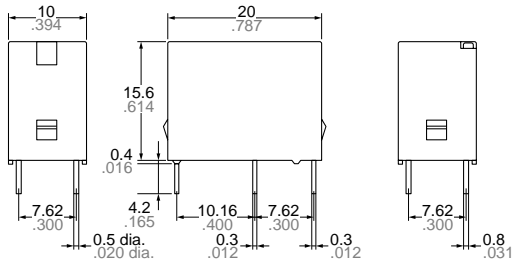

1 Form A

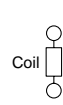

Schematic (Bottom view)

1 Form C

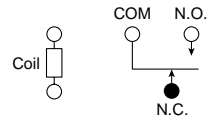
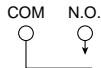

1 Form C

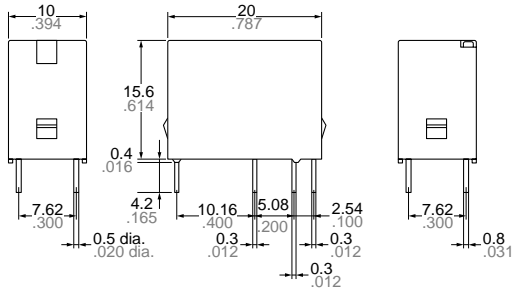

1 Form A

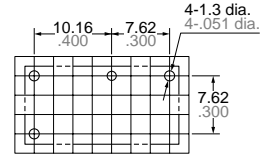

1 Form C

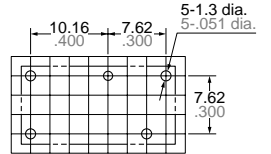

Tolerance:  $\pm 0.1 \pm 0.004$

**Dimension :**

Max. 1mm .039 inch  
 1 to 5mm .039 to .118 inch  
 Min. 5mm .118 inch

**General tolerance**

$\pm 0.2 \pm 0.008$   
 $\pm 0.3 \pm 0.012$   
 $\pm 0.4 \pm 0.016$

# REFERENCE DATA

Max. switching capacity (1 Form A type)

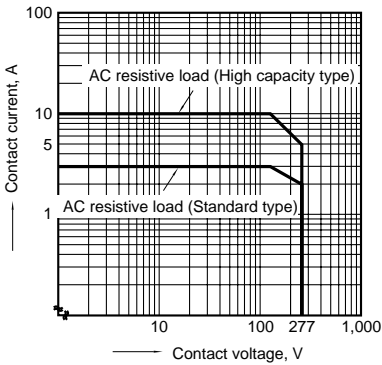

Max. switching capacity (1 Form C type)

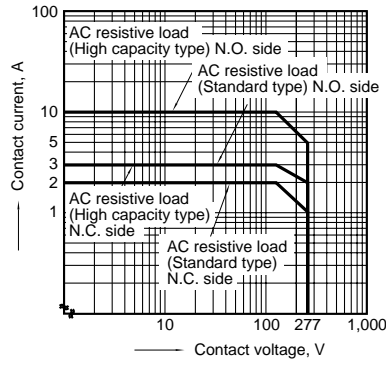

**Standard type**

1-(1). Operate & release time (1 Form A type)

Tested sample: JQ1a-12V, 25 pcs.

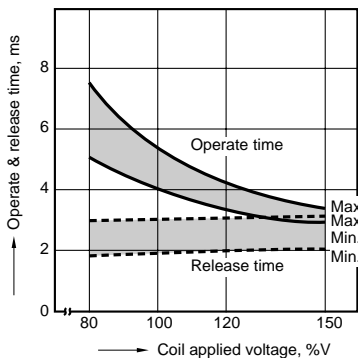

1-(2). Operate & release time (1 Form C type)

Tested sample: JQ1-24V, 25 pcs.

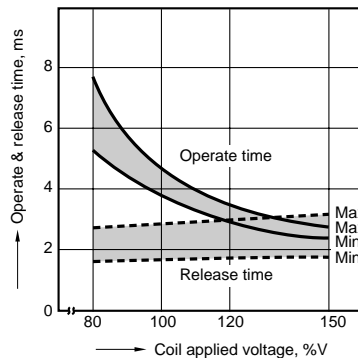

2. Life curve

Ambient temperature: room temperature

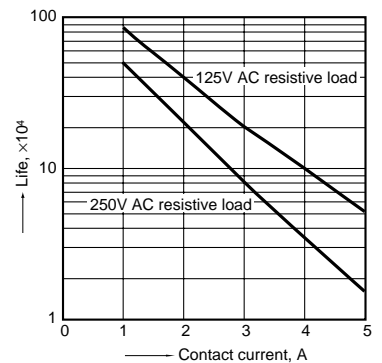

3-(1). Coil temperature rise  
(1 Form A type)

Contact carrying current: 3 A, 5 A  
Measured portion: Inside the coil

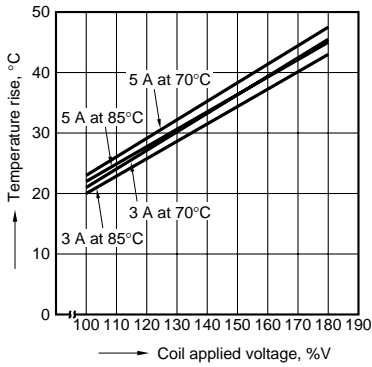

3-(2). Coil temperature rise  
(1 Form C type)

Contact carrying current: 3 A, 5 A  
Measured portion: Inside the coil

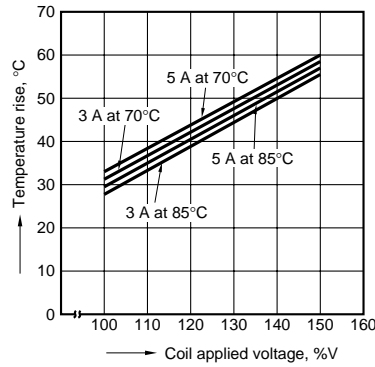

4-(1). Ambient temperature characteristics  
(1 Form A type)

Tested sample: JQ1a-24V  
Contact carrying current: 3 A, 5 A

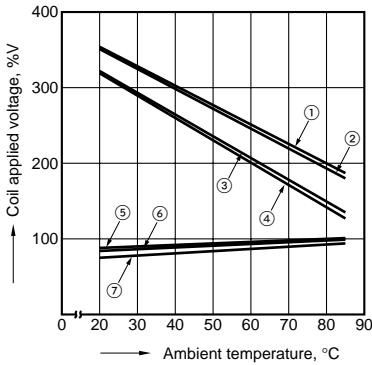

4-(2). Ambient temperature characteristics  
(1 Form C type)

Tested sample: JQ1-24V  
Contact carrying current: 3 A, 5 A

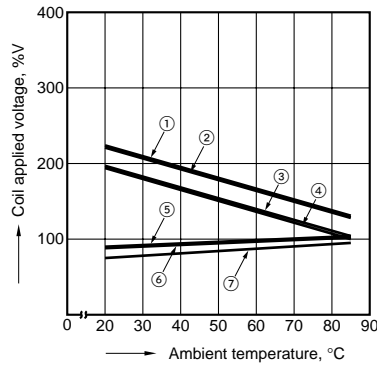

- ① Allowable ambient temperature against % coil voltage (max. inside the coil temperature set as 130°C 266°F) (Carrying current: 3 A)
- ② Allowable ambient temperature against % coil voltage (max. inside the coil temperature set as 130°C 266°F) (Carrying current: 5 A)
- ③ Allowable ambient temperature against % coil voltage (max. inside the coil temperature set as 115°C 239°F) (Carrying current: 3 A)
- ④ Allowable ambient temperature against % coil voltage (max. inside the coil temperature set as 115°C 239°F) (Carrying current: 5 A)
- ⑤ Pick-up voltage with a hot-start condition of 100%V on the coil (Carrying current: 5 A)
- ⑥ Pick-up voltage with a hot-start condition of 100%V on the coil (Carrying current: 3 A)
- ⑦ Pick-up voltage

High capacity type

1-(1). Operate & release time  
(1 Form A type)

Tested sample: JQ1aP-12V, 25 pcs.

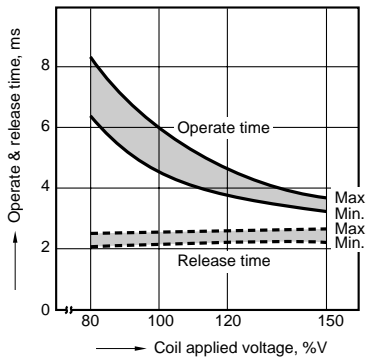

1-(2). Operate & release time  
(1 Form C type)

Tested sample: JQ1P-12V, 25 pcs.

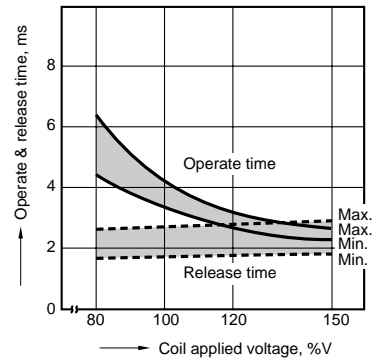

2. Life curve

Ambient temperature: room temperature

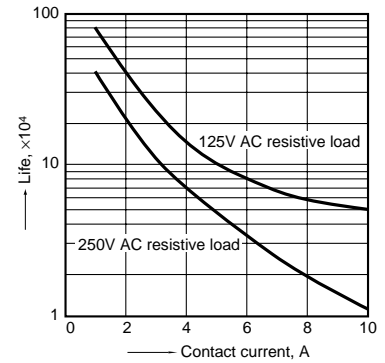

3-(1). Coil temperature rise  
(1 Form A type)

Contact carrying current: 5 A, 10 A  
Measured portion: Inside the coil

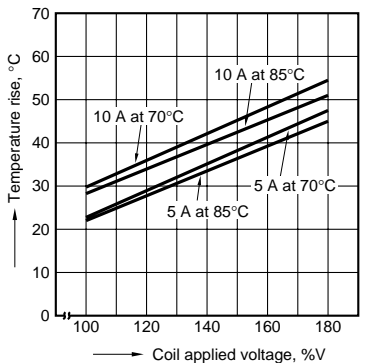

3-(2). Coil temperature rise  
(1 Form C type)

Contact carrying current: 5 A, 10 A  
Measured portion: Inside the coil

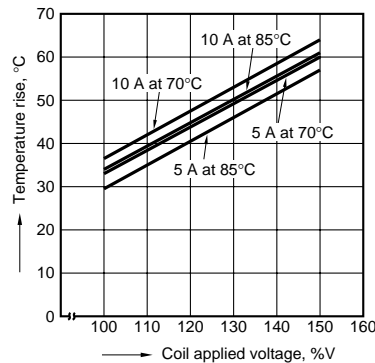

4-(1). Ambient temperature characteristics  
(1 Form A type)

Tested sample: JQ1aP-24V  
Contact carrying current: 5 A, 10 A

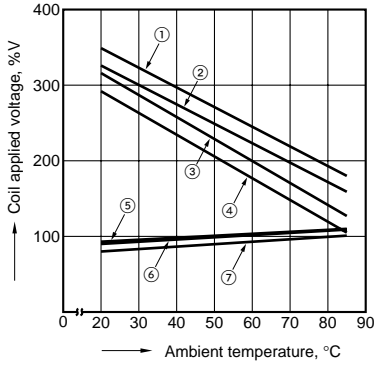

4-(2). Ambient temperature characteristics  
(1 Form C type)

Tested sample: JQ1P-24V  
Contact carrying current: 5 A, 10 A

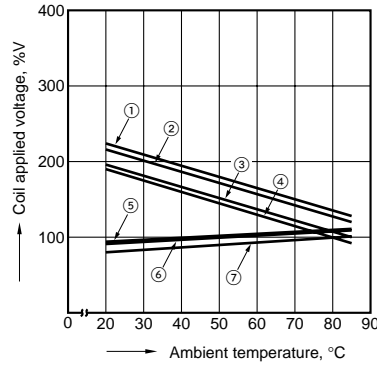

- ① Allowable ambient temperature against % coil voltage (max. inside the coil temperature set as 130°C 266°F) (Carrying current: 5 A)
- ② Allowable ambient temperature against % coil voltage (max. inside the coil temperature set as 130°C 266°F) (Carrying current: 10 A)
- ③ Allowable ambient temperature against % coil voltage (max. inside the coil temperature set as 115°C 239°F) (Carrying current: 5 A)
- ④ Allowable ambient temperature against % coil voltage (max. inside the coil temperature set as 115°C 239°F) (Carrying current: 10 A)
- ⑤ Pick-up voltage with a hot-start condition of 100%V on the coil (Carrying current: 10 A)
- ⑥ Pick-up voltage with a hot-start condition of 100%V on the coil (Carrying current: 5 A)
- ⑦ Pick-up voltage

**For Cautions for Use, see Relay Technical Information (Page 11 to 39).**