

# Low Signal Relay G6K

- Fourth generation design.
- Design based on worldwide communications, computer peripheral and office automation relay requirements.
- Offers excellent board space savings.
- Meets 2.5 kV Bellcore surge requirements.
- Terminal design based on Omron's successful G6S relay.
- Available in PCB through-hole, SMT gullwing and SMT "inside-L" terminals.
- Ambient temperature range of -40 to +85°C.
- Complies with UL1950 Basic Insulation at 125 V.
- Available in 2.54 and 3.2 mm coil-contact terminal spacing versions.
- Available in single coil latching.
- RoHS Compliant.

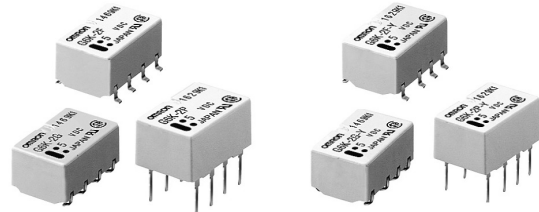

## Ordering Information

To Order: Select the part number and add the desired coil voltage rating (e.g., G6K-2F-DC5).

Terminal	Contact form	Model		
		Non-latching 2.54 mm spacing	Non-latching 3.2 mm coil-contact terminal spacing	Single coil latching 3.2 mm coil-contact terminal spacing
Gullwing	DPDT	G6K-2F	G6K-2F-Y	G6KU-2F-Y
Inside "L"	DPDT	G6K-2G	G6K-2G-Y	G6KU-2G-Y
PCB through-hole	DPDT	G6K-2P	G6K-2P-Y	G6KU-2P-Y

## Specifications

### ■ Contact data

Load	Resistive load (cosφ=1)
Rated load	0.3 A at 125 VAC
	1 A at 30 VDC
Contact material	Ag (Au clad)
Max. carry current	1 A
Max. operating voltage	125 VAC, 60 VDC
Max. operating current	1 A
Max. switching capacity	37.5 VA, 30W
Min. permissible load	10 μA at 10 mVDC

**G6K- 2.5 mm coil-contact terminal spacing, standard, non-latching (G6K-2F, G6K-2G, G6K-2P)**

**G6K- 3.2 mm coil-contact terminal spacing, non-latching (G6K-2F-Y, G6K-2G-Y, G6K-2P-Y)**

Rated voltage (VDC)	Rated current (mA)	Coil resistance (Ω)	Pick-up voltage	Dropout voltage	Maximum voltage	Power consumption (mW)
			% of rated value			
3	33.0	91	80% max.	10% min.	150% max. (at 85°C)	100 (approx.)
4.5	23.2	194				
5	21.1	237				
6	17.6	341				
9	11.3	795				
12	9.1	1,315				
24	4.6	5,220				

**G6KU- 3.2 mm spacing, single coil latching (G6KU-2F-Y, G6KU-2G-Y, G6KU-2P-Y)**

Rated voltage (VDC)	Rated current (mA)	Coil resistance (Ω)	Set-up voltage	Reset voltage	Maximum voltage	Power consumption (mW)
			% of rated value			
3	33.0	91	80% max.	80 % min.	150% max. (at 85°C)	100 (approx.)
4.5	23.2	194				
5	21.1	237				
6	17.6	341				
9	11.3	795				
12	9.1	1,315				
24	4.6	5,220				

- Note:**
1. The rated current and coil resistance are measured at a coil temperature of 23°C (73°F) with a tolerance of ± 10%.
  2. The operating characteristics are measured at a coil temperature of 23°C (73°F) unless otherwise specified.
  3. Pick-up voltage is measured with no carry current across the contacts.
  4. Pick-up voltage will vary with temperature.
  5. Specifications subject to change without notice.

## ■ Characteristics

<b>Contact resistance (initial)</b>		100 mΩ max.
<b>Operate time (set time)</b>		3 ms max.
<b>Release time (reset time)</b>		3 ms max.
<b>Bounce time</b>		3 ms max
<b>Insulation resistance</b>		1,000 MΩ min. (at 500 VDC)
<b>Dielectric strength</b>		1,500 VAC for 1 minute between coil contacts 1,000 VAC for 1 minute between contacts of different poles 750 VAC for 1 minute between contacts of the same pole
<b>Surge withstand voltage</b>		2,500 V, 2x10 μs (conforms to Bellcore specifications) between coil and contacts 1,500 V, 10x160 μs (conforms to FCC Part 68) between contacts of different poles 1,500 V, 10x160 μs (conforms to FCC Part 68) between contacts of the same pole
<b>Vibration</b>	<b>Mechanical durability</b>	10 to 55 Hz; 5.0 mm double amplitude
	<b>Malfunction durability</b>	10 to 55 Hz; 3.3 mm double amplitude
<b>Shock</b>	<b>Mechanical durability</b>	1,000 m/s <sup>2</sup> , approx. 100G
	<b>Malfunction durability</b>	750 m/s <sup>2</sup> , approx. 75G
<b>Ambient temperature</b>		-40°C to 85°C (-40°F to 185°F)
<b>Humidity</b>		35 to 85% RH
<b>Service life</b>	<b>Mechanical</b>	50,000,000 operations min. (at 36,000 operations per hour)
	<b>Electrical</b>	100,000 operations min. at rated load (at 1,800 operations per hour)

**Note:** Data shown are of initial value.

# Characteristic data

## Max. Switching Capacity

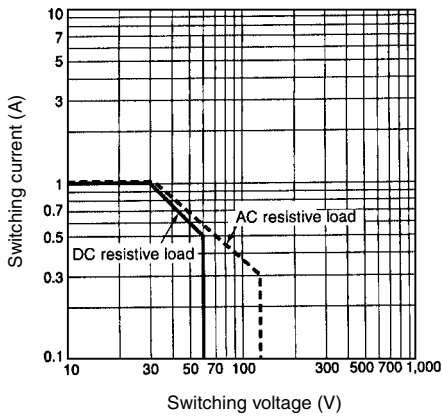

## Ambient Temperature vs. Maximum Coil Voltage

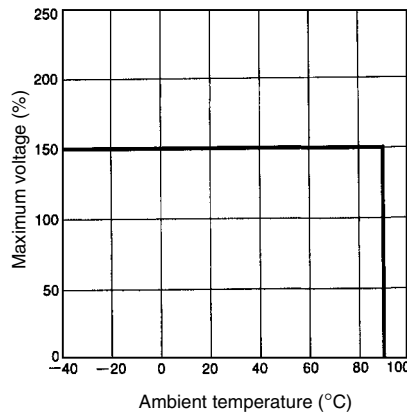

## Ambient Temperature vs. Pick-up and Dropout Voltage

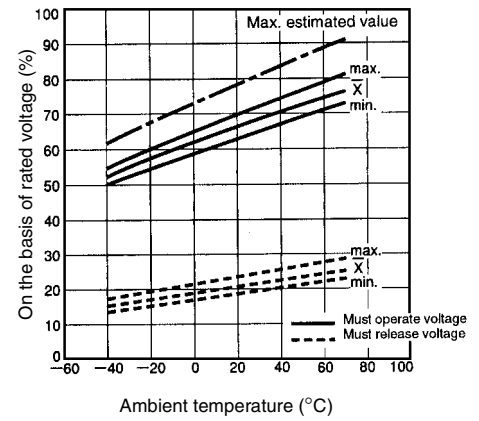

## Electrical Service Life

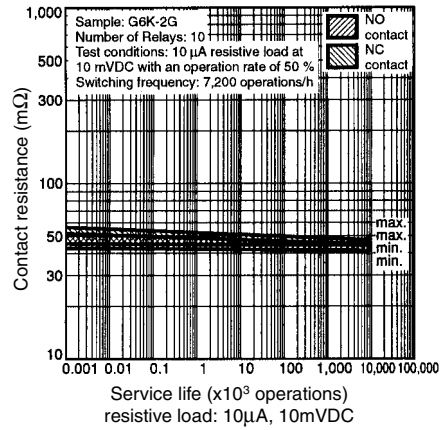
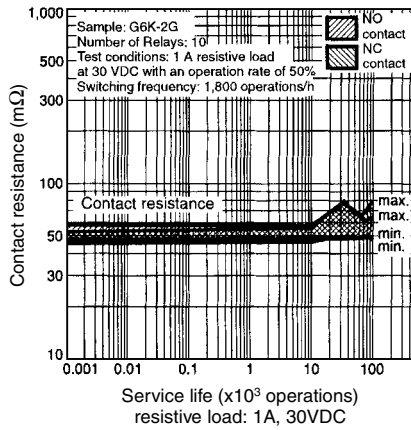
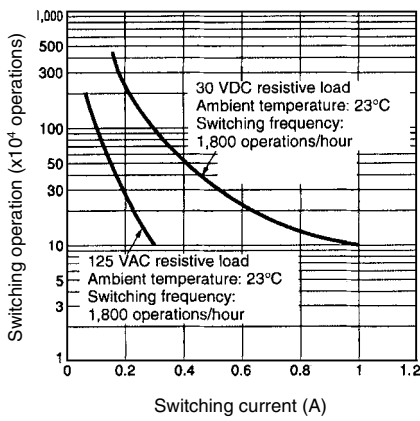

## High-frequency Characteristics

### Isolation

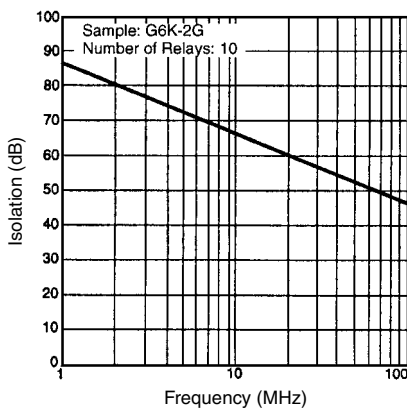

### Insertion Loss

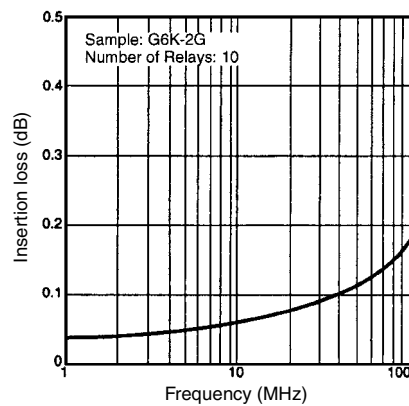

### VSWR and Return Loss

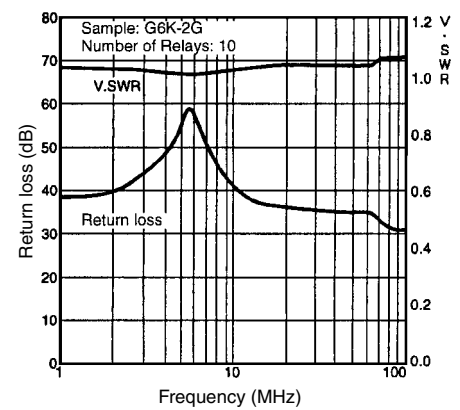

■ Approvals

UL (File No. E41515) / CSA (File No. LR24825)

Type	Contact form	Coil rating	Contact ratings
G6K-2F G6K-2G G6K-2P1 G6K-2F-Y G6K-2G-Y G6K-2P-Y G6KU-2F-Y G6KU-2G-Y G6KU-2P-Y	DPDT	3 to 24 VDC	0.3 A, 125 VAC 0.5 A, 60 VDC 1 A, 30 VDC

Note: Complies with UL1950 Basic Insulation at 125 V (pollution degree 1 for internal spacings, pollution degree 2 for external spacings).

Dimensions

Unit: mm (inch)

■ Relays

G6K-2F

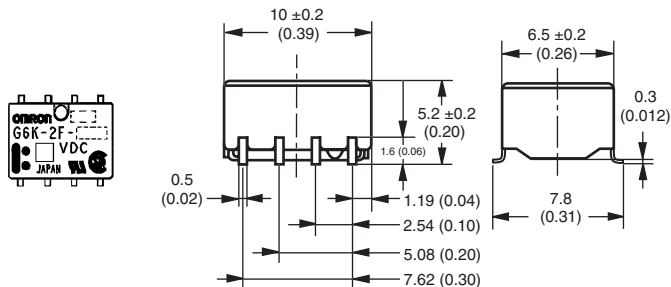

Terminal arrangement/  
Internal connections  
(top view)

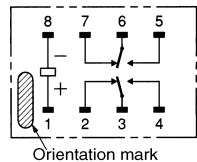

Mounting pads  
(top view)

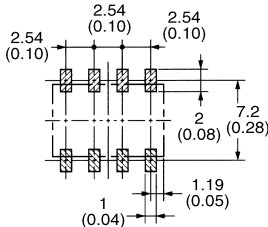

G6K-2G

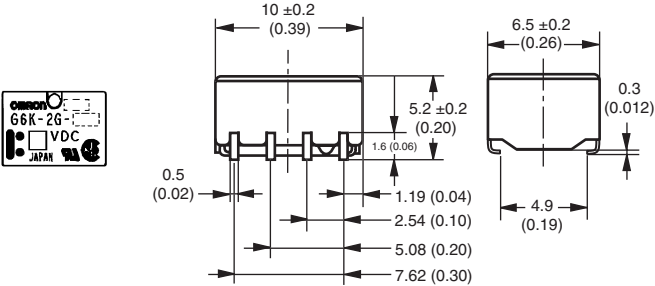

Terminal arrangement/  
Internal connections  
(top view)

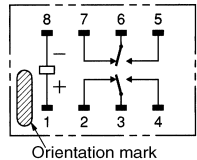

Mounting pads  
(top view)

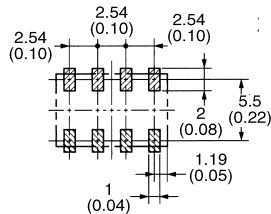

**G6K-2P**

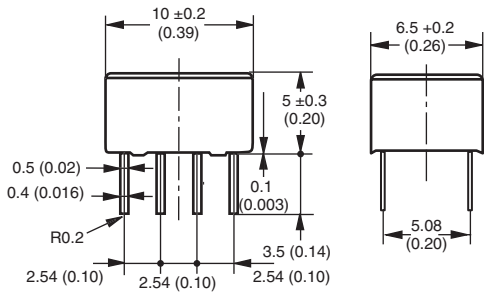
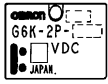

**Terminal arrangement/  
Internal connections  
(bottom view)**

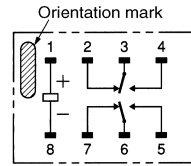

**Mounting pads  
(bottom view)**

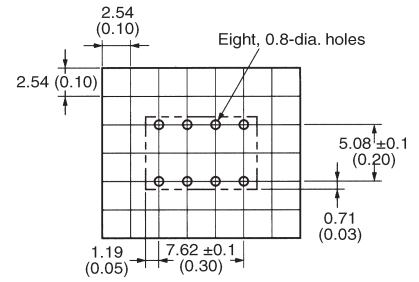

**G6K-2F-Y**

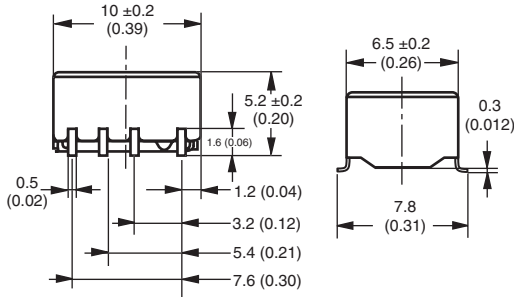
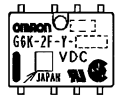

**Terminal arrangement/  
Internal connections  
(top view)**

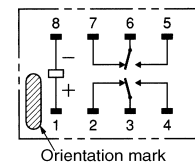

**Mounting pads  
(top view)**

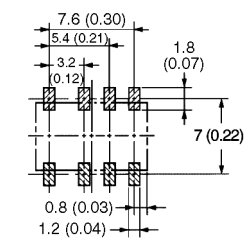

**G6K-2G-Y**

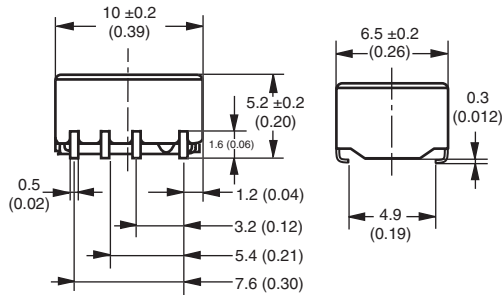
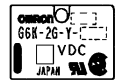

**Terminal arrangement/  
Internal connections  
(top view)**

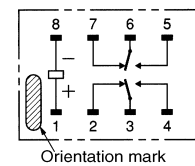

**Mounting pads  
(top view)**

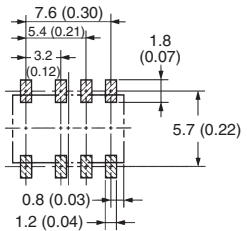

**G6K-2P-Y**

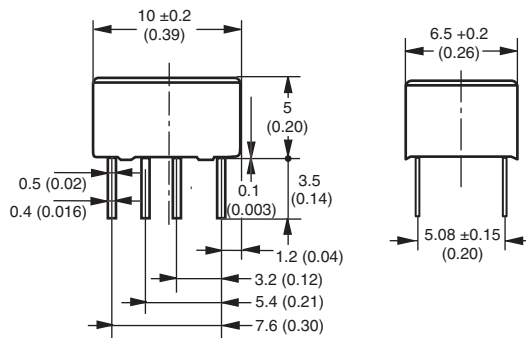

**Terminal arrangement/  
Internal connections  
(bottom view)**

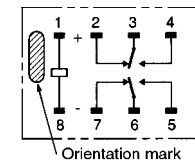

**Mounting pads  
(bottom view)**

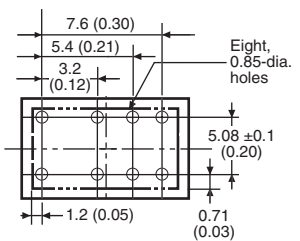

**G6KU-2F-Y**

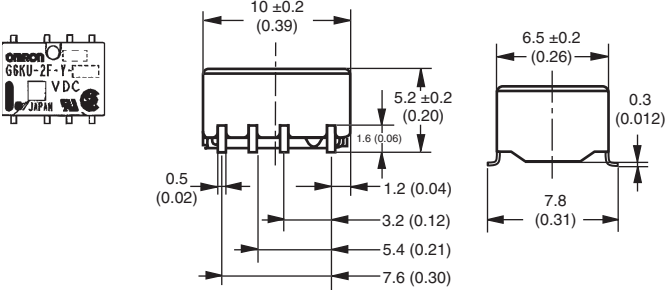

**Terminal arrangement/  
Internal connections  
(top view)**

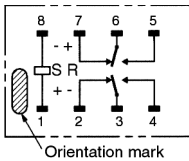

**Mounting pads  
(top view)**

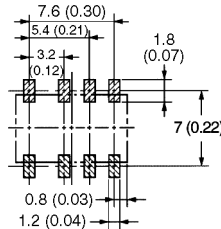

**G6KU-2G-Y**

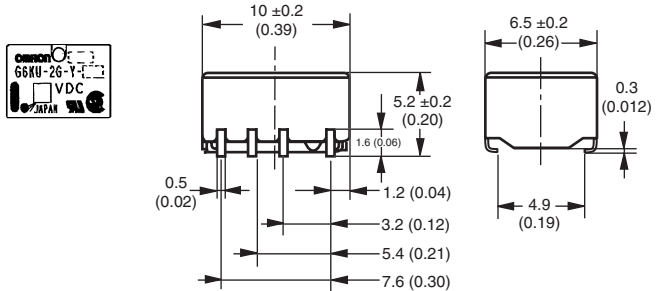

**Terminal arrangement/  
Internal connections  
(top view)**

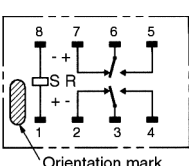

**Mounting pads  
(top view)**

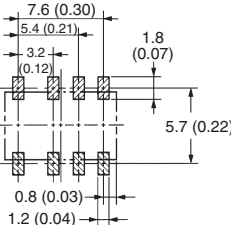

**G6KU-2P-Y**

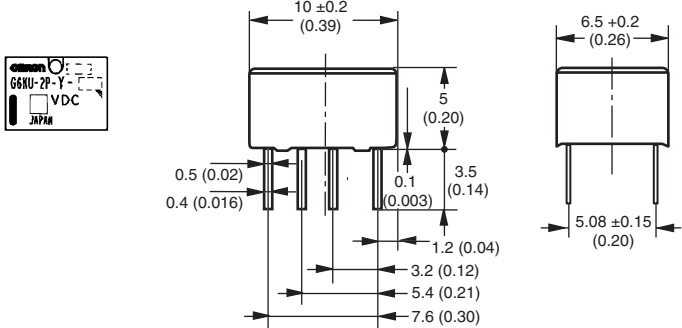

**Terminal arrangement/  
Internal connections  
(bottom view)**

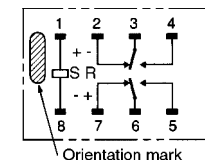

**Mounting pads  
(bottom view)**

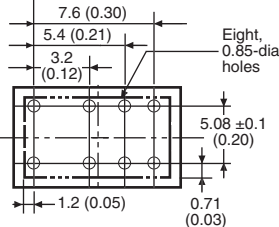

## Accessories

Relays in tube packing are arranged so that the orientation mark of each Relay is on the left side. Be sure to reference Relay orientation when mounting the Relay to the PCB.

Tube packing	Standard nomenclature	50 pcs per anti-static tube
Tape packing	When ordering, add "TR" before the rated coil voltage (e.g., G6K-2G-TR-DC5). Note: TR is not part of the relay model number and will not be marked on the relay.	900 pcs per reel (see details below)

## Tape and Reel Dimensions

- Tape type: ETX7200 (EIAJ - Electronic Industrial Association of Japan)
- 16 mm tape meets EIA Standards  
5.6 mm pocket depth  
12 mm pitch  
4 mm sprocket pitch
- Reel type: RPM-16D (EIAJ), 330 mm
- Relays per reel: 900

### 1. Direction of Relay Insertion

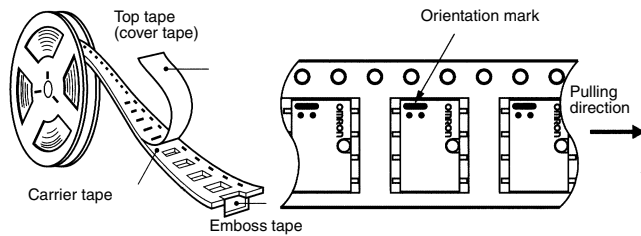

### 2. Reel Dimensions

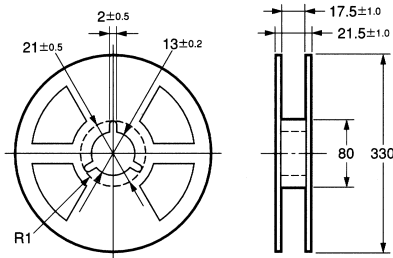

### 3. Carrier Tape Dimensions

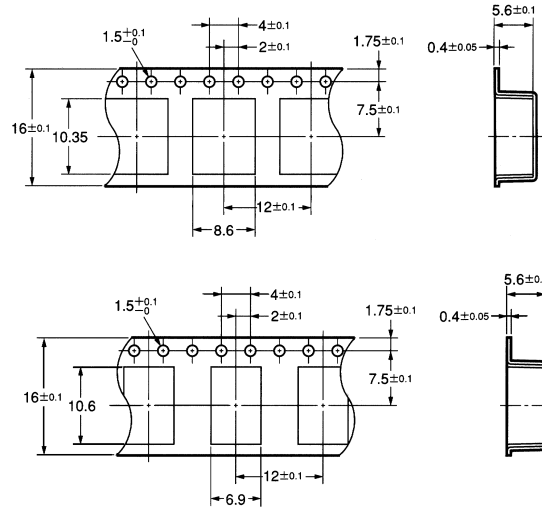

# Precautions

## ■ Correct Use

### Handling

Do not unpack the relay until mounting it.

### Soldering

Solder: JIS Z3282, H63A or equivalent

Soldering temperature: Approx. 250°C (260°C if the DWS method is used)

Soldering time: Approx. 5 s max. (approx. 2 s for the first time and approx. 3 s for the second time if the DWS method is used)

Be sure to make a molten solder level adjustment so that the solder will not overflow on the PCB.

### Claw Securing Force During Automatic Mounting

During automatic insertion of Relays, make sure to set the securing force of each claw to the following so that the Relays characteristics will be maintained.

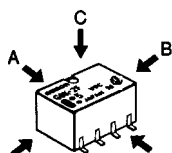

Direction A: 1.96 N  
 Direction B: 4.90 N  
 Direction C: 1.96 N

### Environmental Conditions During Operation, Storage, and Transportation

It is best to keep the relay in its packaging in a controlled environment until it is ready for mounting.

If the Relay is stored for a long time in an adverse environment with high temperature, high humidity, organic gases, or sulfide gases, sulfide or oxide films will form on the contact surfaces. These films may result in unstable contact, contact problems, or functional problems. Therefore, operate, store, or transport the product under specified environmental conditions.

### Latching Relay Mounting

Make sure that the vibration or shock that is generated from other devices, such as relays in operation, on the same panel and imposed on the Latching Relay does not exceed the rated value, otherwise the Latching Relay that has been set may be reset or vice versa. The Latching Relay is reset before shipping. If excessive vibration or shock is imposed, however, the Latching Relay may be set accidentally. Be sure to apply a reset signal before use.

### Maximum Allowable Voltage

The maximum allowable voltage of the coil can be obtained from the coil temperature increase and the heat-resisting temperature of coil insulating sheath material. (Exceeding the heat-resisting temperature may result in burning or short-circuiting.) The maximum allowable voltage also involves important restrictions which include the following:

- Must not cause thermal changes in or deterioration of the insulating material.
- Must not cause damage to other control devices.
- Must not cause any harmful effect on people.
- Must not cause fire.

Therefore, be sure to use the maximum allowable voltage as specified in the catalog.

As a rule, the rated voltage must be applied to the coil. A voltage exceeding the rated value, however, can be applied to the coil provided that the voltage is less than or equal to the maximum allowable voltage. It must be noted that continuous voltage application to the coil will cause a coil temperature increase which may affect characteristics such as electrical life and coil insulation.

### Coating

The Relay mounting on the PCB may be coated or washed but do not apply silicone coating or detergent containing silicone, otherwise the silicone coating or detergent may remain on the surface of the Relay.

### PCB Mounting

If two or more Relays are closely mounted with the long sides of the Relays facing each other and soldering is performed with infrared radiation, the solder may not be properly exposed to the infrared rays. Be sure to keep the proper distance between adjacent Relays as shown below to insure formation of good solder joints.

G6K-2G

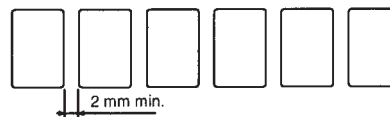

G6K-2F

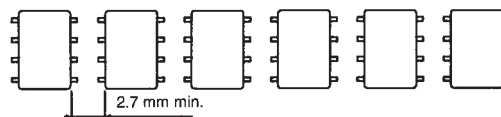

Two or more Relays may be mounted as closely as desired with the short sides of the Relays facing each other.



# Terms and Conditions of Sale

1. Offer; Acceptance. These terms and conditions (these "Terms") are deemed part of all quotations, acknowledgments, invoices, purchase orders and other documents, whether electronic or in writing, relating to the sale of products or services (collectively, the "Products") by Omron Electronic Components LLC ("Seller"). Seller hereby objects to any terms or conditions proposed in Buyer's purchase order or other documents which are inconsistent with, or in addition to, these Terms.
2. Prices; Payment. All prices stated are current, subject to change without notice by Seller. Buyer agrees to pay the price in effect at time of shipment. Payments for Products received are due net 30 days unless otherwise stated in the invoice.
3. Discounts. Cash discounts, if any, will apply only on the net amount of invoices sent to Buyer after deducting transportation charges, taxes and duties, and will be allowed only if (i) the invoice is paid according to Seller's payment terms and (ii) Buyer has no past due amounts owing to Seller.
4. Currencies. If the prices quoted herein are in a currency other than U.S. dollars, Buyer shall make remittance to Seller at the then current exchange rate most favorable to Seller and which is available on the due date; provided that if remittance is not made when due, Buyer will convert the amount to U.S. dollars at the then current exchange rate most favorable to Seller available during the period between the due date and the date remittance is actually made.
5. Governmental Approvals. Buyer shall be responsible for, and shall bear all costs involved in, obtaining any government approvals required for the importation or sale of the Products.
6. Taxes. All taxes, duties and other governmental charges (other than general real property and income taxes), including any interest or penalties thereon, imposed directly or indirectly on Seller or required to be collected directly or indirectly by Seller for the manufacture, production, sale, delivery, importation, consumption or use of the Products sold hereunder (including customs duties and sales, excise, use, turnover and license taxes) shall be charged to and remitted by Buyer to Seller.
7. Financial. If the financial position of Buyer at any time becomes unsatisfactory to Seller, Seller reserves the right to stop shipments or require satisfactory security or payment in advance. If Buyer fails to make payment or otherwise comply with these Terms or any related agreement, Seller may (without liability and in addition to other remedies) cancel any unshipped portion of Products sold hereunder and stop any Products in transit until Buyer pays all amounts, including amounts payable hereunder, whether or not then due, which are owing to it by Buyer. Buyer shall in any event remain liable for all unpaid accounts.
8. Cancellation; Etc. Orders are not subject to rescheduling or cancellation unless Buyer indemnifies Seller fully against all costs or expenses arising in connection therewith.
9. Force Majeure. Seller shall not be liable for any delay or failure in delivery resulting from causes beyond its control, including earthquakes, fires, floods, strikes or other labor disputes, shortage of labor or materials, accidents to machinery, acts of sabotage, riots, delay in or lack of transportation or the requirements of any government authority.
10. Shipping; Delivery. Unless otherwise expressly agreed in writing by Seller:
  1. Shipments shall be by a carrier selected by Seller;
  2. Such carrier shall act as the agent of Buyer and delivery to such carrier shall constitute delivery to Buyer;
  3. All sales and shipments of Products shall be FOB shipping point (unless otherwise stated in writing by Seller), at which point title to and all risk of loss of the Products shall pass from Seller to Buyer, provided that Seller shall retain a security interest in the Products until the full purchase price is paid by Buyer;
  4. Delivery and shipping dates are estimates only.
  5. Seller will package Products as it deems proper for protection against normal handling and extra charges apply to special conditions.
11. Claims. Any claim by Buyer against Seller for shortage or damage to the Products occurring before delivery to the carrier must be presented in writing to Seller within 30 days of receipt of shipment and include the original transportation bill signed by the carrier noting that the carrier received the Products from Seller in the condition claimed.
12. Warranties. (a) Exclusive Warranty. Seller's exclusive warranty is that the Products will be free from defects in materials and workmanship for a period of twelve months from the date of sale by Seller (or such other period expressed in writing by Seller). Seller disclaims all other warranties, express or implied. (b) Limitations. SELLER MAKES NO WARRANTY OR REPRESENTATION, EXPRESS OR IMPLIED, ABOUT NON-INFRINGEMENT, MERCHANTABILITY OR FITNESS FOR A PARTICULAR PURPOSE OF THE PRODUCTS. BUYER ACKNOWLEDGES THAT IT ALONE HAS DETERMINED THAT THE PRODUCTS WILL SUITABLY MEET THE REQUIREMENTS OF THEIR INTENDED USE. Seller further disclaims all warranties and responsibility of any type for claims or expenses based on infringement by the Products or otherwise of any intellectual property right. (c) Buyer Remedy. Seller's sole obligation hereunder shall be to replace (in the form originally shipped with Buyer responsible for labor charges for removal or replacement thereof) the non-complying Product or, at Seller's election, to repay or credit Buyer an amount equal to the purchase price of the Product; provided that in no event shall Seller be responsible for warranty, repair, indemnity or any other claims or expenses regarding the Products unless Seller's analysis confirms that the Products were properly handled, stored, installed and maintained and not subject to contamination, abuse, misuse or inappropriate modification. Return of any Products by Buyer must be approved in writing by Seller before shipment. Seller shall not be liable for the suitability or unsuitability or the results from the use of Products in combination with any electrical or electronic components, circuits, system assemblies, or any other materials or substances or environments. Any advice, recommendations or information given orally or in writing are not to be construed as an amendment to the above warranty.
13. Limitation on Liability; Etc. SELLER SHALL NOT BE LIABLE FOR SPECIAL, INDIRECT, INCIDENTAL OR CONSEQUENTIAL DAMAGES, LOSS OF PROFITS OR PRODUCTION OR COMMERCIAL LOSS IN ANY WAY CONNECTED WITH THE PRODUCTS, WHETHER SUCH CLAIM IS BASED IN CONTRACT, WARRANTY, NEGLIGENCE OR STRICT LIABILITY. Further, in no event shall liability of Seller exceed the individual price of the Product on which liability is asserted.
14. Indemnities. Buyer shall indemnify and hold harmless Seller, its affiliates and its employees from and against all liabilities, losses, claims, costs and expenses (including attorney's fees and expenses) related to any claim, investigation, litigation or proceeding (whether or not Seller is a party) which arises or is alleged to arise from Buyer's acts or omissions under these Terms or in any way with respect to the Products. Without limiting the foregoing, Buyer (at its own expense) shall indemnify and hold harmless Seller and defend or settle any action brought against Seller to the extent that it is based on a claim that any Product made to Buyer specifications infringed intellectual property rights of another party.
15. Property; Confidentiality. The intellectual property embodied in the Products is the exclusive property of Seller and its affiliates and Buyer shall not attempt to duplicate it in any way without the written permission of Seller. Notwithstanding any charges to Buyer for engineering or tooling, all engineering and tooling supplied by Seller to Buyer relating to the Products are confidential and proprietary, and Buyer shall limit distribution thereof to its trusted employees and strictly prevent disclosure to any third party.
16. Miscellaneous. (a) Waiver. No failure or delay by Seller in exercising any right and no course of dealing between Buyer and Seller shall operate as a waiver of rights by Seller. (b) Assignment. Buyer may not assign its rights hereunder without Seller's written consent. (c) Law. These Terms are governed by Illinois law (without regard to conflict of law principles). Federal and state courts in Illinois shall have exclusive jurisdiction for any dispute hereunder. (d) Amendment. These Terms constitute the entire agreement between Buyer and Seller relating to the Products, and no provision may be changed or waived unless in writing signed by the parties. (e) Severability. If any provision hereof is rendered ineffective or invalid, such provision shall not invalidate any other provision. (f) Setoff. Buyer shall have no right to set off any amounts against the amount owing in respect of this invoice. (g) Definitions. As used herein, "including" means "including without limitation".

## Certain Precautions on Specifications and Use

1. **Suitability for Use.** Seller shall not be responsible for conformity with any standards, codes or regulations which apply to the combination of the Product in Buyer's application or use of the Product. At Buyer's request, Seller will provide applicable third party certification documents identifying ratings and limitations of use which apply to the Product. This information by itself is not sufficient for a complete determination of the suitability of the Product in combination with the end product, machine, system, or other application or use. Buyer shall be solely responsible for determining appropriateness of the particular Product with respect to Buyer's application, product or system. Buyer shall take application responsibility in all cases but the following is a non-exhaustive list of applications for which particular attention must be given:
  - (i) Outdoor use, uses involving potential chemical contamination or electrical interference, or conditions or uses not described in this document.
  - (ii) Energy control systems, combustion systems, railroad systems, aviation systems, medical equipment, amusement machines, vehicles, safety equipment, and installations subject to separate industry or government regulations.
  - (iii) Use in consumer products or any use in significant quantities.
  - (iv) Systems, machines and equipment that could present a risk to life or property. Please know and observe all prohibitions of use applicable to this product.

NEVER USE THE PRODUCT FOR AN APPLICATION INVOLVING SERIOUS RISK TO LIFE OR PROPERTY WITHOUT ENSURING THAT THE SYSTEM AS A WHOLE HAS BEEN DESIGNED TO ADDRESS THE RISKS, AND THAT THE OMRON PRODUCT IS PROPERLY RATED AND INSTALLED FOR THE INTENDED USE WITHIN THE OVERALL EQUIPMENT OR SYSTEM.
2. **Programmable Products.** Seller shall not be responsible for the user's programming of a programmable product, or any consequence thereof.
3. **Performance Data.** Performance data given in this publication is provided as a guide for the user in determining suitability and does not constitute a warranty. It may represent the result of Seller's test conditions, and the users must correlate it to actual application requirements. Actual performance is subject to Seller's Warranty and Limitations of Liability.
4. **Change in Specifications.** Product specifications and accessories may be changed at any time based on improvements and other reasons. It is our practice to change part numbers when published ratings or features are changed or when significant construction changes are made. However, some specifications of the Product may be changed without any notice. When in doubt, special part numbers may be assigned to fix or establish key specifications for your application. Please consult with your Seller representative at any time to confirm actual specifications of purchased Product.
5. **Errors and Omissions.** The information in this publication has been carefully checked and is believed to be accurate; however, no responsibility is assumed for clerical, typographical or proofreading errors, or omissions.
6. **RoHS Compliance.** Where indicated, our products currently comply, to the best of our knowledge as of the date of this publication, with the requirements of the European Union's Directive on the Restriction of certain Hazardous Substances ("RoHS"), although the requirements of RoHS do not take effect until July 2006. These requirements may be subject to change. Please consult our website for current information.

Complete "Terms and Conditions of Sale" for product purchase and use are on Omron's website at [www.components.omron.com](http://www.components.omron.com) – under the "About Us" tab, in the Legal Matters section.

**ALL DIMENSIONS SHOWN ARE IN MILLIMETERS.**

To convert millimeters into inches, multiply by 0.03937. To convert grams into ounces, multiply by 0.03527.

# OMRON®

**OMRON ELECTRONIC  
COMPONENTS LLC**

55 E. Commerce Drive, Suite B  
Schaumburg, IL 60173

**847-882-2288**

**OMRON CANADA, INC.**

885 Milner Avenue  
Toronto, Ontario M1B 5V8

**416-286-6465**

**OMRON ON-LINE**

Global - <http://www.omron.com>

USA - <http://www.components.omron.com>

Canada - <http://www.omron.ca>