

# MC78L00A Series

## Three-Terminal Low Current Positive Voltage Regulators

The MC78L00A Series of positive voltage regulators are inexpensive, easy-to-use devices suitable for a multitude of applications that require a regulated supply of up to 100 mA. Like their higher powered MC7800 and MC78M00 Series cousins, these regulators feature internal current limiting and thermal shutdown making them remarkably rugged. No external components are required with the MC78L00 devices in many applications.

These devices offer a substantial performance advantage over the traditional zener diode-resistor combination, as output impedance and quiescent current are substantially reduced.

- Wide Range of Available, Fixed Output Voltages
- Low Cost
- Internal Short Circuit Current Limiting
- Internal Thermal Overload Protection
- No External Components Required
- Complementary Negative Regulators Offered (MC79L00A Series)

### Representative Schematic Diagram

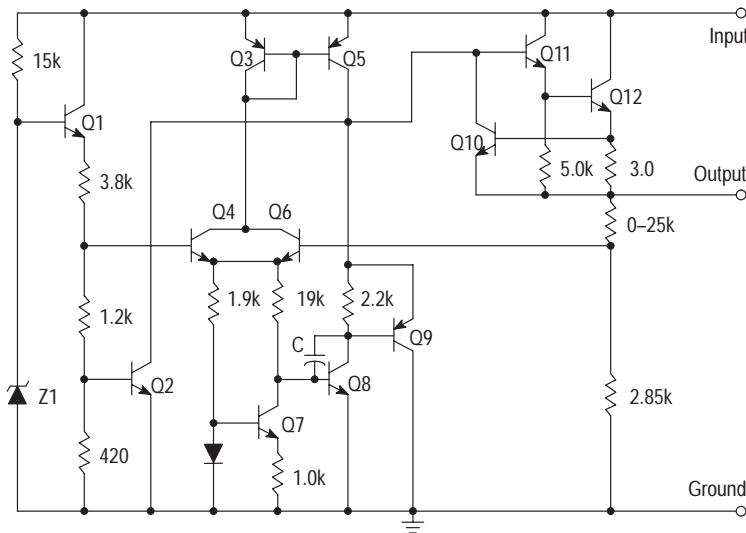

### Standard Application

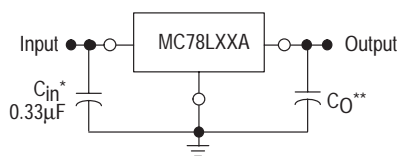

A common ground is required between the input and the output voltages. The input voltage must remain typically 2.0 V above the output voltage even during the low point on the input ripple voltage.

\* $C_{in}$  is required if regulator is located an appreciable distance from power supply filter.

\*\* $C_O$  is not needed for stability; however, it does improve transient response.



**ON Semiconductor**

Formerly a Division of Motorola

<http://onsemi.com>

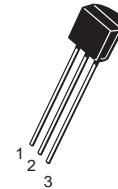

Pin: 1. Output  
2. Ground  
3. Input

**TO-92  
P SUFFIX  
CASE 29**



**SOP-8\*  
D SUFFIX  
CASE 751**

\*SOP-8 is an internally modified SO-8 package. Pins 2, 3, 6, and 7 are electrically common to the die attach flag. This internal lead frame modification decreases package thermal resistance and increases power dissipation capability when appropriately mounted on a printed circuit board. SOP-8 conforms to all external dimensions of the standard SO-8 package.

### PIN CONNECTIONS

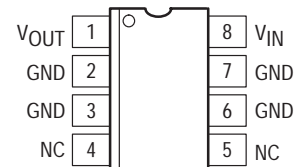

(Top View)

### DEVICE TYPE/NOMINAL VOLTAGE

| 5% Output Voltage Accuracy | Voltage |
|----------------------------|---------|
| MC78L05AC                  | 5.0     |
| MC78L08AC                  | 8.0     |
| MC78L09AC                  | 9.0     |
| MC78L12AC                  | 12      |
| MC78L15AC                  | 15      |
| MC78L18AC                  | 18      |
| MC78L24AC                  | 24      |

### ORDERING INFORMATION

See detailed ordering and shipping information in the package dimensions section on page 7 of this data sheet.

## MC78L00A Series

### MAXIMUM RATINGS ( $T_A = +125^\circ\text{C}$ , unless otherwise noted.)

| Rating   | Symbol    | Value          | Unit             |
|--|-----------|----------------|------------------|
| Input Voltage (2.6 V–8.0 V)<br>(12 V–18 V)<br>(24 V) | $V_I$     | 30<br>35<br>40 | Vdc              |
| Storage Temperature Range                            | $T_{stg}$ | –65 to +150    | $^\circ\text{C}$ |
| Operating Junction Temperature Range                 | $T_J$     | 0 to +150      | $^\circ\text{C}$ |

### ELECTRICAL CHARACTERISTICS ( $V_I = 10\text{ V}$ , $I_O = 40\text{ mA}$ , $C_I = 0.33\text{ }\mu\text{F}$ , $C_O = 0.1\text{ }\mu\text{F}$ , $-40^\circ\text{C} < T_J < +125^\circ\text{C}$ (for MC78LXXAB), $0^\circ\text{C} < T_J < +125^\circ\text{C}$ (for MC78LXXAC), unless otherwise noted.)

| Characteristics   | Symbol                     | MC78L05AC, AB |           |              | Unit          |
|---|----------------------------|---------------|-----------|--------------|---------------|
|   |                            | Min           | Typ       | Max          |               |
| Output Voltage ( $T_J = +25^\circ\text{C}$ )  | $V_O$                      | 4.8           | 5.0       | 5.2          | Vdc           |
| Line Regulation<br>( $T_J = +25^\circ\text{C}$ , $I_O = 40\text{ mA}$ )<br>$7.0\text{ Vdc} \leq V_I \leq 20\text{ Vdc}$<br>$8.0\text{ Vdc} \leq V_I \leq 20\text{ Vdc}$                 | $\text{Reg}_{\text{line}}$ | –<br>–        | 55<br>45  | 150<br>100   | mV            |
| Load Regulation<br>( $T_J = +25^\circ\text{C}$ , $1.0\text{ mA} \leq I_O \leq 100\text{ mA}$ )<br>( $T_J = +25^\circ\text{C}$ , $1.0\text{ mA} \leq I_O \leq 40\text{ mA}$ )            | $\text{Reg}_{\text{load}}$ | –<br>–        | 11<br>5.0 | 60<br>30     | mV            |
| Output Voltage<br>( $7.0\text{ Vdc} \leq V_I \leq 20\text{ Vdc}$ , $1.0\text{ mA} \leq I_O \leq 40\text{ mA}$ )<br>( $V_I = 10\text{ V}$ , $1.0\text{ mA} \leq I_O \leq 70\text{ mA}$ ) | $V_O$                      | 4.75<br>4.75  | –<br>–    | 5.25<br>5.25 | Vdc           |
| Input Bias Current<br>( $T_J = +25^\circ\text{C}$ )<br>( $T_J = +125^\circ\text{C}$ )   | $I_{IB}$                   | –<br>–        | 3.8<br>–  | 6.0<br>5.5   | mA            |
| Input Bias Current Change<br>( $8.0\text{ Vdc} \leq V_I \leq 20\text{ Vdc}$ )<br>( $1.0\text{ mA} \leq I_O \leq 40\text{ mA}$ )   | $\Delta I_{IB}$            | –<br>–        | –<br>–    | 1.5<br>0.1   | mA            |
| Output Noise Voltage<br>( $T_A = +25^\circ\text{C}$ , $10\text{ Hz} \leq f \leq 100\text{ kHz}$ )   | $V_n$                      | –             | 40        | –            | $\mu\text{V}$ |
| Ripple Rejection ( $I_O = 40\text{ mA}$ ,<br>$f = 120\text{ Hz}$ , $8.0\text{ Vdc} \leq V_I \leq 18\text{ V}$ , $T_J = +25^\circ\text{C}$ )   | RR                         | 41            | 49        | –            | dB            |
| Dropout Voltage ( $T_J = +25^\circ\text{C}$ )   | $V_I - V_O$                | –             | 1.7       | –            | Vdc           |

## MC78L00A Series

**ELECTRICAL CHARACTERISTICS** ( $V_I = 14\text{ V}$ ,  $I_O = 40\text{ mA}$ ,  $C_I = 0.33\text{ }\mu\text{F}$ ,  $C_O = 0.1\text{ }\mu\text{F}$ ,  $-40^\circ\text{C} < T_J < +125^\circ\text{C}$  (for MC78LXXAB),  $0^\circ\text{C} < T_J < +125^\circ\text{C}$  (for MC78LXXAC), unless otherwise noted.)

| Characteristics  | Symbol              | MC78L08AC, AB |           |            | Unit          |
|--|---------------------|---------------|-----------|------------|---------------|
|  |                     | Min           | Typ       | Max        |               |
| Output Voltage ( $T_J = +25^\circ\text{C}$ )   | $V_O$               | 7.7           | 8.0       | 8.3        | Vdc           |
| Line Regulation<br>( $T_J = +25^\circ\text{C}$ , $I_O = 40\text{ mA}$ )<br>$10.5\text{ Vdc} \leq V_I \leq 23\text{ Vdc}$<br>$11\text{ Vdc} \leq V_I \leq 23\text{ Vdc}$                  | Reg <sub>line</sub> | –<br>–        | 20<br>12  | 175<br>125 | mV            |
| Load Regulation<br>( $T_J = +25^\circ\text{C}$ , $1.0\text{ mA} \leq I_O \leq 100\text{ mA}$ )<br>( $T_J = +25^\circ\text{C}$ , $1.0\text{ mA} \leq I_O \leq 40\text{ mA}$ )             | Reg <sub>load</sub> | –<br>–        | 15<br>8.0 | 80<br>40   | mV            |
| Output Voltage<br>( $10.5\text{ Vdc} \leq V_I \leq 23\text{ Vdc}$ , $1.0\text{ mA} \leq I_O \leq 40\text{ mA}$ )<br>( $V_I = 14\text{ V}$ , $1.0\text{ mA} \leq I_O \leq 70\text{ mA}$ ) | $V_O$               | 7.6<br>7.6    | –<br>–    | 8.4<br>8.4 | Vdc           |
| Input Bias Current<br>( $T_J = +25^\circ\text{C}$ )<br>( $T_J = +125^\circ\text{C}$ )  | $I_{IB}$            | –<br>–        | 3.0<br>–  | 6.0<br>5.5 | mA            |
| Input Bias Current Change<br>( $11\text{ Vdc} \leq V_I \leq 23\text{ Vdc}$ )<br>( $1.0\text{ mA} \leq I_O \leq 40\text{ mA}$ )   | $\Delta I_{IB}$     | –<br>–        | –<br>–    | 1.5<br>0.1 | mA            |
| Output Noise Voltage<br>( $T_A = +25^\circ\text{C}$ , $10\text{ Hz} \leq f \leq 100\text{ kHz}$ )  | $V_n$               | –             | 60        | –          | $\mu\text{V}$ |
| Ripple Rejection ( $I_O = 40\text{ mA}$ ,<br>$f = 120\text{ Hz}$ , $12\text{ V} \leq V_I \leq 23\text{ V}$ , $T_J = +25^\circ\text{C}$ )   | RR                  | 37            | 57        | –          | dB            |
| Dropout Voltage ( $T_J = +25^\circ\text{C}$ )  | $V_I - V_O$         | –             | 1.7       | –          | Vdc           |

**ELECTRICAL CHARACTERISTICS** ( $V_I = 15\text{ V}$ ,  $I_O = 40\text{ mA}$ ,  $C_I = 0.33\text{ }\mu\text{F}$ ,  $C_O = 0.1\text{ }\mu\text{F}$ ,  $-40^\circ\text{C} < T_J < +125^\circ\text{C}$  (for MC78LXXAB),  $0^\circ\text{C} < T_J < +125^\circ\text{C}$  (for MC78LXXAC), unless otherwise noted.)

| Characteristics  | Symbol              | MC78L09AC, AB |           |            | Unit          |
|--|---------------------|---------------|-----------|------------|---------------|
|  |                     | Min           | Typ       | Max        |               |
| Output Voltage ( $T_J = +25^\circ\text{C}$ )   | $V_O$               | 8.6           | 9.0       | 9.4        | Vdc           |
| Line Regulation<br>( $T_J = +25^\circ\text{C}$ , $I_O = 40\text{ mA}$ )<br>$11.5\text{ Vdc} \leq V_I \leq 24\text{ Vdc}$<br>$12\text{ Vdc} \leq V_I \leq 24\text{ Vdc}$                  | Reg <sub>line</sub> | –<br>–        | 20<br>12  | 175<br>125 | mV            |
| Load Regulation<br>( $T_J = +25^\circ\text{C}$ , $1.0\text{ mA} \leq I_O \leq 100\text{ mA}$ )<br>( $T_J = +25^\circ\text{C}$ , $1.0\text{ mA} \leq I_O \leq 40\text{ mA}$ )             | Reg <sub>load</sub> | –<br>–        | 15<br>8.0 | 90<br>40   | mV            |
| Output Voltage<br>( $11.5\text{ Vdc} \leq V_I \leq 24\text{ Vdc}$ , $1.0\text{ mA} \leq I_O \leq 40\text{ mA}$ )<br>( $V_I = 15\text{ V}$ , $1.0\text{ mA} \leq I_O \leq 70\text{ mA}$ ) | $V_O$               | 8.5<br>8.5    | –<br>–    | 9.5<br>9.5 | Vdc           |
| Input Bias Current<br>( $T_J = +25^\circ\text{C}$ )<br>( $T_J = +125^\circ\text{C}$ )  | $I_{IB}$            | –<br>–        | 3.0<br>–  | 6.0<br>5.5 | mA            |
| Input Bias Current Change<br>( $11\text{ Vdc} \leq V_I \leq 23\text{ Vdc}$ )<br>( $1.0\text{ mA} \leq I_O \leq 40\text{ mA}$ )   | $\Delta I_{IB}$     | –<br>–        | –<br>–    | 1.5<br>0.1 | mA            |
| Output Noise Voltage<br>( $T_A = +25^\circ\text{C}$ , $10\text{ Hz} \leq f \leq 100\text{ kHz}$ )  | $V_n$               | –             | 60        | –          | $\mu\text{V}$ |
| Ripple Rejection ( $I_O = 40\text{ mA}$ ,<br>$f = 120\text{ Hz}$ , $13\text{ V} \leq V_I \leq 24\text{ V}$ , $T_J = +25^\circ\text{C}$ )   | RR                  | 37            | 57        | –          | dB            |
| Dropout Voltage<br>( $T_J = +25^\circ\text{C}$ )   | $V_I - V_O$         | –             | 1.7       | –          | Vdc           |

## MC78L00A Series

**ELECTRICAL CHARACTERISTICS** ( $V_I = 19\text{ V}$ ,  $I_O = 40\text{ mA}$ ,  $C_I = 0.33\text{ }\mu\text{F}$ ,  $C_O = 0.1\text{ }\mu\text{F}$ ,  $-40^\circ\text{C} < T_J < +125^\circ\text{C}$  (for MC78LXXAB),  $0^\circ\text{C} < T_J < +125^\circ\text{C}$  (for MC78LXXAC), unless otherwise noted.)

| Characteristics  | Symbol              | MC78L12AC, AB |            |              | Unit          |
|--|---------------------|---------------|------------|--------------|---------------|
|  |                     | Min           | Typ        | Max          |               |
| Output Voltage ( $T_J = +25^\circ\text{C}$ )   | $V_O$               | 11.5          | 12         | 12.5         | Vdc           |
| Line Regulation<br>( $T_J = +25^\circ\text{C}$ , $I_O = 40\text{ mA}$ )<br>$14.5\text{ Vdc} \leq V_I \leq 27\text{ Vdc}$<br>$16\text{ Vdc} \leq V_I \leq 27\text{ Vdc}$                  | Reg <sub>line</sub> | –<br>–        | 120<br>100 | 250<br>200   | mV            |
| Load Regulation<br>( $T_J = +25^\circ\text{C}$ , $1.0\text{ mA} \leq I_O \leq 100\text{ mA}$ )<br>( $T_J = +25^\circ\text{C}$ , $1.0\text{ mA} \leq I_O \leq 40\text{ mA}$ )             | Reg <sub>load</sub> | –<br>–        | 20<br>10   | 100<br>50    | mV            |
| Output Voltage<br>( $14.5\text{ Vdc} \leq V_I \leq 27\text{ Vdc}$ , $1.0\text{ mA} \leq I_O \leq 40\text{ mA}$ )<br>( $V_I = 19\text{ V}$ , $1.0\text{ mA} \leq I_O \leq 70\text{ mA}$ ) | $V_O$               | 11.4<br>11.4  | –<br>–     | 12.6<br>12.6 | Vdc           |
| Input Bias Current<br>( $T_J = +25^\circ\text{C}$ )<br>( $T_J = +125^\circ\text{C}$ )  | $I_{IB}$            | –<br>–        | 4.2<br>–   | 6.5<br>6.0   | mA            |
| Input Bias Current Change<br>( $16\text{ Vdc} \leq V_I \leq 27\text{ Vdc}$ )<br>( $1.0\text{ mA} \leq I_O \leq 40\text{ mA}$ )   | $\Delta I_{IB}$     | –<br>–        | –<br>–     | 1.5<br>0.1   | mA            |
| Output Noise Voltage<br>( $T_A = +25^\circ\text{C}$ , $10\text{ Hz} \leq f \leq 100\text{ kHz}$ )  | $V_n$               | –             | 80         | –            | $\mu\text{V}$ |
| Ripple Rejection ( $I_O = 40\text{ mA}$ ,<br>$f = 120\text{ Hz}$ , $15\text{ V} \leq V_I \leq 25\text{ V}$ , $T_J = +25^\circ\text{C}$ )   | RR                  | 37            | 42         | –            | dB            |
| Dropout Voltage<br>( $T_J = +25^\circ\text{C}$ )   | $V_I - V_O$         | –             | 1.7        | –            | Vdc           |

**ELECTRICAL CHARACTERISTICS** ( $V_I = 23\text{ V}$ ,  $I_O = 40\text{ mA}$ ,  $C_I = 0.33\text{ }\mu\text{F}$ ,  $C_O = 0.1\text{ }\mu\text{F}$ ,  $-40^\circ\text{C} < T_J < +125^\circ\text{C}$  (for MC78LXXAB),  $0^\circ\text{C} < T_J < +125^\circ\text{C}$  (for MC78LXXAC), unless otherwise noted.)

| Characteristics  | Symbol              | MC78L15AC, AB  |            |                | Unit          |
|--|---------------------|----------------|------------|----------------|---------------|
|  |                     | Min            | Typ        | Max            |               |
| Output Voltage ( $T_J = +25^\circ\text{C}$ )   | $V_O$               | 14.4           | 15         | 15.6           | Vdc           |
| Line Regulation<br>( $T_J = +25^\circ\text{C}$ , $I_O = 40\text{ mA}$ )<br>$17.5\text{ Vdc} \leq V_I \leq 30\text{ Vdc}$<br>$20\text{ Vdc} \leq V_I \leq 30\text{ Vdc}$                  | Reg <sub>line</sub> | –<br>–         | 130<br>110 | 300<br>250     | mV            |
| Load Regulation<br>( $T_J = +25^\circ\text{C}$ , $1.0\text{ mA} \leq I_O \leq 100\text{ mA}$ )<br>( $T_J = +25^\circ\text{C}$ , $1.0\text{ mA} \leq I_O \leq 40\text{ mA}$ )             | Reg <sub>load</sub> | –<br>–         | 25<br>12   | 150<br>75      | mV            |
| Output Voltage<br>( $17.5\text{ Vdc} \leq V_I \leq 30\text{ Vdc}$ , $1.0\text{ mA} \leq I_O \leq 40\text{ mA}$ )<br>( $V_I = 23\text{ V}$ , $1.0\text{ mA} \leq I_O \leq 70\text{ mA}$ ) | $V_O$               | 14.25<br>14.25 | –<br>–     | 15.75<br>15.75 | Vdc           |
| Input Bias Current<br>( $T_J = +25^\circ\text{C}$ )<br>( $T_J = +125^\circ\text{C}$ )  | $I_{IB}$            | –<br>–         | 4.4<br>–   | 6.5<br>6.0     | mA            |
| Input Bias Current Change<br>( $20\text{ Vdc} \leq V_I \leq 30\text{ Vdc}$ )<br>( $1.0\text{ mA} \leq I_O \leq 40\text{ mA}$ )   | $\Delta I_{IB}$     | –<br>–         | –<br>–     | 1.5<br>0.1     | mA            |
| Output Noise Voltage<br>( $T_A = +25^\circ\text{C}$ , $10\text{ Hz} \leq f \leq 100\text{ kHz}$ )  | $V_n$               | –              | 90         | –              | $\mu\text{V}$ |
| Ripple Rejection ( $I_O = 40\text{ mA}$ ,<br>$f = 120\text{ Hz}$ , $18.5\text{ V} \leq V_I \leq 28.5\text{ V}$ , $T_J = +25^\circ\text{C}$ )   | RR                  | 34             | 39         | –              | dB            |
| Dropout Voltage<br>( $T_J = +25^\circ\text{C}$ )   | $V_I - V_O$         | –              | 1.7        | –              | Vdc           |

## MC78L00A Series

**ELECTRICAL CHARACTERISTICS** ( $V_I = 27\text{ V}$ ,  $I_O = 40\text{ mA}$ ,  $C_I = 0.33\text{ }\mu\text{F}$ ,  $C_O = 0.1\text{ }\mu\text{F}$ ,  $0^\circ\text{C} < T_J < +125^\circ\text{C}$ , unless otherwise noted.)

| Characteristics  | Symbol              | MC78L18AC |     |      | Unit          |
|--|---------------------|-----------|-----|------|---------------|
|  |                     | Min       | Typ | Max  |               |
| Output Voltage ( $T_J = +25^\circ\text{C}$ )   | $V_O$               | 17.3      | 18  | 18.7 | Vdc           |
| Line Regulation<br>( $T_J = +25^\circ\text{C}$ , $I_O = 40\text{ mA}$ )<br>$21.4\text{ Vdc} \leq V_I \leq 33\text{ Vdc}$<br>$20.7\text{ Vdc} \leq V_I \leq 33\text{ Vdc}$<br>$22\text{ Vdc} \leq V_I \leq 33\text{ Vdc}$<br>$21\text{ Vdc} \leq V_I \leq 33\text{ Vdc}$  | Reg <sub>line</sub> | –         | 45  | 325  | mV            |
| Load Regulation<br>( $T_J = +25^\circ\text{C}$ , $1.0\text{ mA} \leq I_O \leq 100\text{ mA}$ )<br>( $T_J = +25^\circ\text{C}$ , $1.0\text{ mA} \leq I_O \leq 40\text{ mA}$ )   | Reg <sub>load</sub> | –         | 30  | 170  | mV            |
| Output Voltage<br>( $21.4\text{ Vdc} \leq V_I \leq 33\text{ Vdc}$ , $1.0\text{ mA} \leq I_O \leq 40\text{ mA}$ )<br>( $20.7\text{ Vdc} \leq V_I \leq 33\text{ Vdc}$ , $1.0\text{ mA} \leq I_O \leq 40\text{ mA}$ )<br>( $V_I = 27\text{ V}$ , $1.0\text{ mA} \leq I_O \leq 70\text{ mA}$ )<br>( $V_I = 27\text{ V}$ , $1.0\text{ mA} \leq I_O \leq 70\text{ mA}$ ) | $V_O$               | 17.1      | –   | 18.9 | Vdc           |
| Input Bias Current<br>( $T_J = +25^\circ\text{C}$ )<br>( $T_J = +125^\circ\text{C}$ )  | $I_{IB}$            | –         | 3.1 | 6.5  | mA            |
| Input Bias Current Change<br>( $22\text{ Vdc} \leq V_I \leq 33\text{ Vdc}$ )<br>( $21\text{ Vdc} \leq V_I \leq 33\text{ Vdc}$ )<br>( $1.0\text{ mA} \leq I_O \leq 40\text{ mA}$ )  | $\Delta I_{IB}$     | –         | –   | 1.5  | mA            |
| Output Noise Voltage<br>( $T_A = +25^\circ\text{C}$ , $10\text{ Hz} \leq f \leq 100\text{ kHz}$ )  | $V_n$               | –         | 150 | –    | $\mu\text{V}$ |
| Ripple Rejection ( $I_O = 40\text{ mA}$ ,<br>$f = 120\text{ Hz}$ , $23\text{ V} \leq V_I \leq 33\text{ V}$ , $T_J = +25^\circ\text{C}$ )   | RR                  | 33        | 48  | –    | dB            |
| Dropout Voltage<br>( $T_J = +25^\circ\text{C}$ )   | $V_I - V_O$         | –         | 1.7 | –    | Vdc           |

**ELECTRICAL CHARACTERISTICS** ( $V_I = 33\text{ V}$ ,  $I_O = 40\text{ mA}$ ,  $C_I = 0.33\text{ }\mu\text{F}$ ,  $C_O = 0.1\text{ }\mu\text{F}$ ,  $0^\circ\text{C} < T_J < +125^\circ\text{C}$ , unless otherwise noted.)

| Characteristics  | Symbol              | MC78L24AC |     |      | Unit          |
|--|---------------------|-----------|-----|------|---------------|
|  |                     | Min       | Typ | Max  |               |
| Output Voltage ( $T_J = +25^\circ\text{C}$ )   | $V_O$               | 23        | 24  | 25   | Vdc           |
| Line Regulation<br>( $T_J = +25^\circ\text{C}$ , $I_O = 40\text{ mA}$ )<br>$27.5\text{ Vdc} \leq V_I \leq 38\text{ Vdc}$<br>$28\text{ Vdc} \leq V_I \leq 80\text{ Vdc}$<br>$27\text{ Vdc} \leq V_I \leq 38\text{ Vdc}$   | Reg <sub>line</sub> | –         | –   | –    | mV            |
| Load Regulation<br>( $T_J = +25^\circ\text{C}$ , $1.0\text{ mA} \leq I_O \leq 100\text{ mA}$ )<br>( $T_J = +25^\circ\text{C}$ , $1.0\text{ mA} \leq I_O \leq 40\text{ mA}$ )   | Reg <sub>load</sub> | –         | 40  | 200  | mV            |
| Output Voltage<br>( $28\text{ Vdc} \leq V_I \leq 38\text{ Vdc}$ , $1.0\text{ mA} \leq I_O \leq 40\text{ mA}$ )<br>( $27\text{ Vdc} \leq V_I \leq 38\text{ Vdc}$ , $1.0\text{ mA} \leq I_O \leq 40\text{ mA}$ )<br>( $28\text{ Vdc} \leq V_I \leq 33\text{ Vdc}$ , $1.0\text{ mA} \leq I_O \leq 70\text{ mA}$ )<br>( $27\text{ Vdc} \leq V_I \leq 33\text{ Vdc}$ , $1.0\text{ mA} \leq I_O \leq 70\text{ mA}$ ) | $V_O$               | 22.8      | –   | 25.2 | Vdc           |
| Input Bias Current<br>( $T_J = +25^\circ\text{C}$ )<br>( $T_J = +125^\circ\text{C}$ )  | $I_{IB}$            | –         | 3.1 | 6.5  | mA            |
| Input Bias Current Change<br>( $28\text{ Vdc} \leq V_I \leq 38\text{ Vdc}$ )<br>( $1.0\text{ mA} \leq I_O \leq 40\text{ mA}$ )   | $\Delta I_{IB}$     | –         | –   | 1.5  | mA            |
| Output Noise Voltage<br>( $T_A = +25^\circ\text{C}$ , $10\text{ Hz} \leq f \leq 100\text{ kHz}$ )  | $V_n$               | –         | 200 | –    | $\mu\text{V}$ |
| Ripple Rejection ( $I_O = 40\text{ mA}$ ,<br>$f = 120\text{ Hz}$ , $29\text{ V} \leq V_I \leq 35\text{ V}$ , $T_J = +25^\circ\text{C}$ )   | RR                  | 31        | 45  | –    | dB            |
| Dropout Voltage<br>( $T_J = +25^\circ\text{C}$ )   | $V_I - V_O$         | –         | 1.7 | –    | Vdc           |

# MC78L00A Series

**Figure 1. Dropout Characteristics**

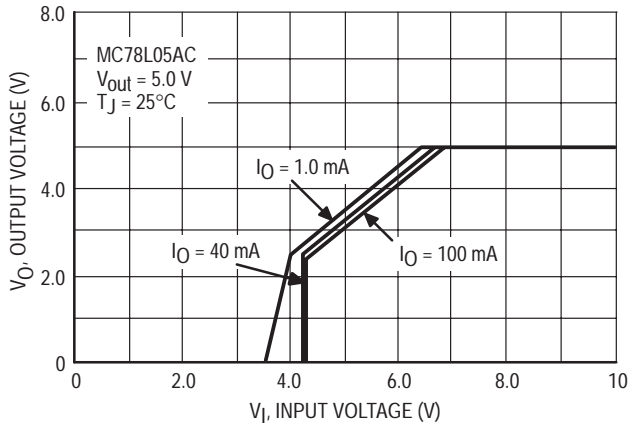

**Figure 2. Dropout Voltage versus Junction Temperature**

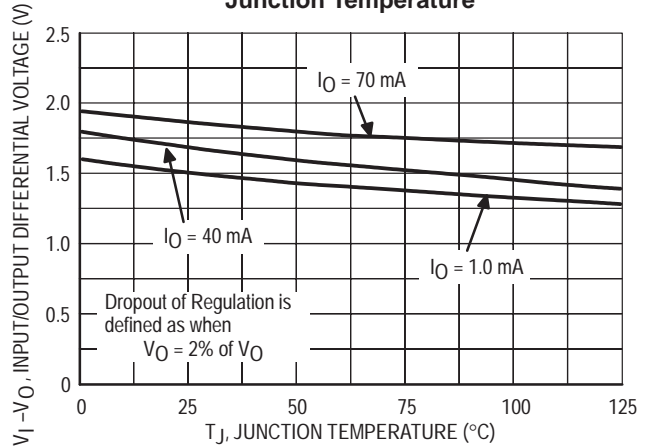

**Figure 3. Input Bias Current versus Ambient Temperature**

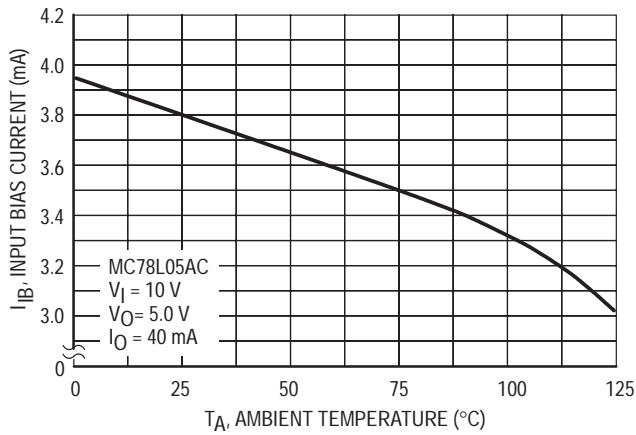

**Figure 4. Input Bias Current versus Input Voltage**

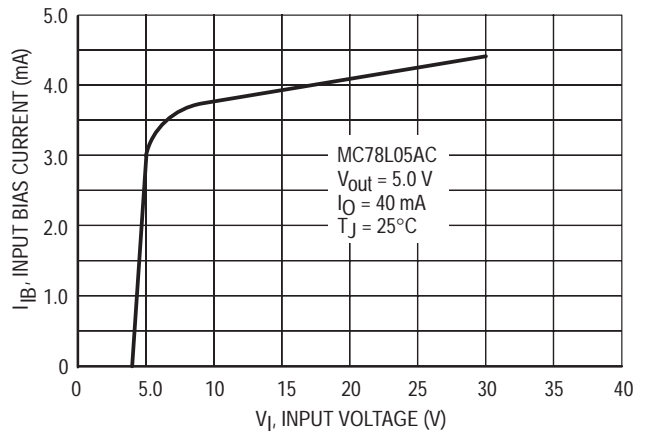

**Figure 5. Maximum Average Power Dissipation versus Ambient Temperature – TO-92 Type Package**

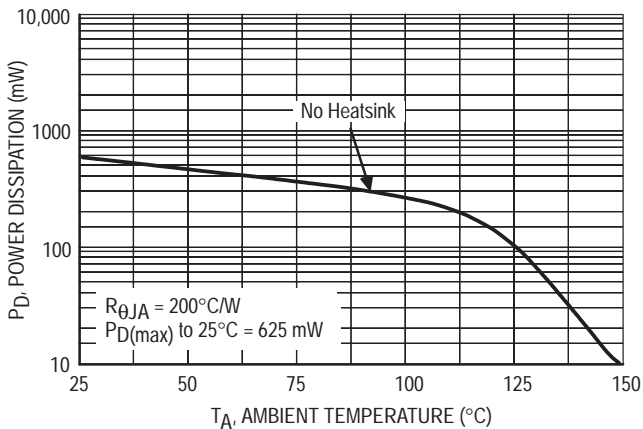

**Figure 6. SOP-8 Thermal Resistance and Maximum Power Dissipation versus P.C.B. Copper Length**

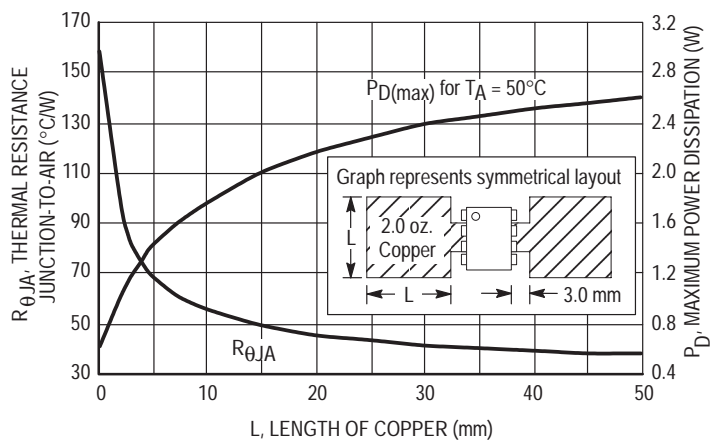

# MC78L00A Series

## APPLICATIONS INFORMATION

### Design Considerations

The MC78L00A Series of fixed voltage regulators are designed with Thermal Overload Protection that shuts down the circuit when subjected to an excessive power overload condition. Internal Short Circuit Protection limits the maximum current the circuit will pass.

In many low current applications, compensation capacitors are not required. However, it is recommended that the regulator input be bypassed with a capacitor if the regulator is connected to the power supply filter with long wire lengths, or if the output load capacitance is large. The

input bypass capacitor should be selected to provide good high-frequency characteristics to insure stable operation under all load conditions. A 0.33 μF or larger tantalum, mylar, or other capacitor having low internal impedance at high frequencies should be chosen. The bypass capacitor should be mounted with the shortest possible leads directly across the regulators input terminals. Good construction techniques should be used to minimize ground loops and lead resistance drops since the regulator has no external sense lead. Bypassing the output is also recommended.

**Figure 7. Current Regulator**

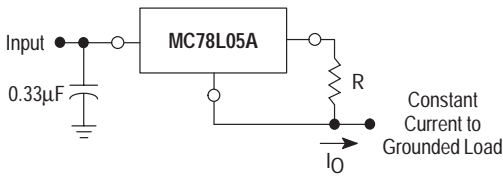

The MC78L00 regulators can also be used as a current source when connected as above. In order to minimize dissipation the MC78L05C is chosen in this application. Resistor R determines the current as follows:

$$I_O = \frac{5.0V}{R} + I_B$$

$$I_B = 3.8 \text{ mA over line and load changes}$$

For example, a 100 mA current source would require R to be a 50 Ω, 1/2 W resistor and the output voltage compliance would be the input voltage less 7 V.

**Figure 8. ± 15 V Tracking Voltage Regulator**

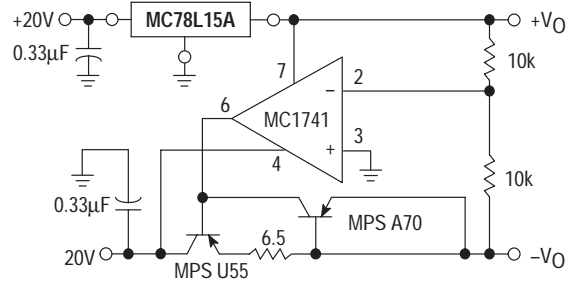

**Figure 9. Positive and Negative Regulator**

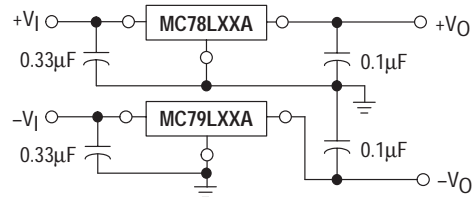

## ORDERING INFORMATION

| Device                      | Operating Temperature Range                      | Package             | Shipping                 |
|-----------------------------|--|---------------------|--------------------------|
| MC78LXXACD*                 | $T_J = 0^\circ \text{ to } +125^\circ\text{C}$   | SOP-8               | 98 Units / Rail          |
| MC78LXXACDR2*               |  | SOP-8 / Tape & Reel | 2500 Units / Tape & Reel |
| MC78LXXACP                  |  | TO-92               | 2000 Units / Bag         |
| MC78LXXACPRA / MC78LXXACPRE |  | TO-92 / Tape & Reel | 2000 Units / Tape & Reel |
| MC78LXXACPRM / MC78LXXACPRP |  | TO-92 / Ammo Pack   | 2000 Units / Ammo Pack   |
| MC78LXXABD*                 | $T_J = -40^\circ \text{ to } +125^\circ\text{C}$ | SOP-8               | 98 Units / Rail          |
| MC78LXXABDR2*               |  | SOP-8 / Tape & Reel | 2500 Units / Tape & Reel |
| MC78LXXABP*                 |  | TO-92               | 2000 Units / Bag         |
| MC78LXXABPRA / MC78LXXABPRE |  | TO-92 / Tape & Reel | 2000 Units / Tape & Reel |
| MC78LXXABPRM / MC78LXXABPRP |  | TO-92 / Ammo Pack   | 2000 Units / Ammo Pack   |

XX indicates nominal voltage

\*Available in 5, 8, 9, 12 and 15 V devices.

# MC78L00A Series

## PACKAGE DIMENSIONS

**P SUFFIX**  
**PLASTIC PACKAGE**  
**CASE 29-04**  
**ISSUE AD**

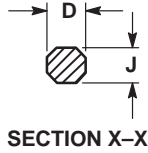
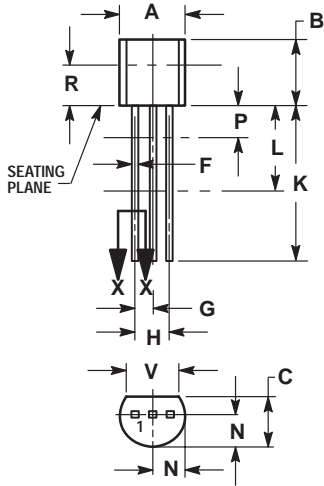

- NOTES:
1. DIMENSIONING AND TOLERANCING PER ANSI Y14.5M, 1982.
  2. CONTROLLING DIMENSION: INCH.
  3. CONTOUR OF PACKAGE BEYOND DIMENSION R IS UNCONTROLLED.
  4. DIMENSION F APPLIES BETWEEN P AND L. DIMENSION D AND J APPLY BETWEEN L AND K. MINIMUM LEAD DIMENSION IS UNCONTROLLED IN P AND BEYOND DIMENSION K MINIMUM.

| DIM | INCHES |       | MILLIMETERS |      |
|-----|--------|-------|-------------|------|
|     | MIN    | MAX   | MIN         | MAX  |
| A   | 0.175  | 0.205 | 4.45        | 5.20 |
| B   | 0.170  | 0.210 | 4.32        | 5.33 |
| C   | 0.125  | 0.165 | 3.18        | 4.19 |
| D   | 0.016  | 0.022 | 0.41        | 0.55 |
| F   | 0.016  | 0.019 | 0.41        | 0.48 |
| G   | 0.045  | 0.055 | 1.15        | 1.39 |
| H   | 0.095  | 0.105 | 2.42        | 2.66 |
| J   | 0.015  | 0.020 | 0.39        | 0.50 |
| K   | 0.500  | ---   | 12.70       | ---  |
| L   | 0.250  | ---   | 6.35        | ---  |
| N   | 0.080  | 0.105 | 2.04        | 2.66 |
| P   | ---    | 0.100 | ---         | 2.54 |
| R   | 0.115  | ---   | 2.93        | ---  |
| V   | 0.135  | ---   | 3.43        | ---  |

**(SOP-8)**  
**D SUFFIX**  
**PLASTIC PACKAGE**  
**CASE 751-05**  
**ISSUE R**

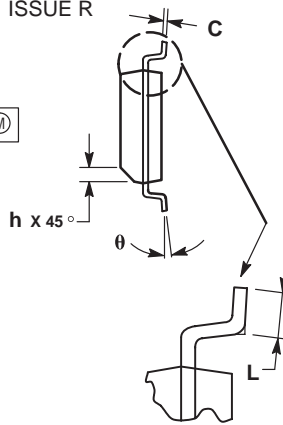
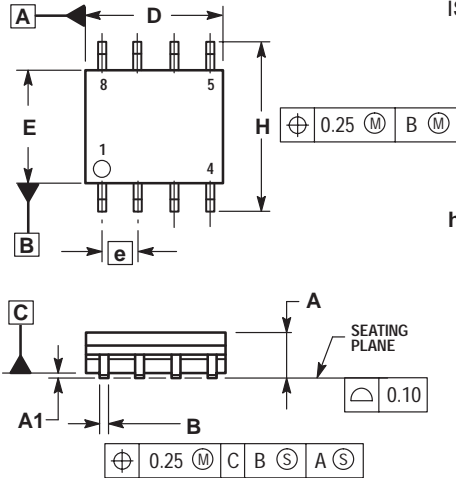

- NOTES:
1. DIMENSIONING AND TOLERANCING PER ASME Y14.5M, 1994.
  2. DIMENSIONS ARE IN MILLIMETERS.
  3. DIMENSION D AND E DO NOT INCLUDE MOLD PROTRUSION.
  4. MAXIMUM MOLD PROTRUSION 0.15 PER SIDE.
  5. DIMENSION B DOES NOT INCLUDE MOLD PROTRUSION. ALLOWABLE DAMBAR PROTRUSION SHALL BE 0.127 TOTAL IN EXCESS OF THE B DIMENSION AT MAXIMUM MATERIAL CONDITION.

| DIM   | MILLIMETERS |      |
|-------|-------------|------|
|       | MIN         | MAX  |
| A     | 1.35        | 1.75 |
| A1    | 0.10        | 0.25 |
| B     | 0.35        | 0.49 |
| C     | 0.18        | 0.25 |
| D     | 4.80        | 5.00 |
| E     | 3.80        | 4.00 |
| e     | 1.27 BSC    |      |
| H     | 5.80        | 6.20 |
| h     | 0.25        | 0.50 |
| L     | 0.40        | 1.25 |
| theta | 0°          | 7°   |

**ON Semiconductor** and are trademarks of Semiconductor Components Industries, LLC (SCILLC). SCILLC reserves the right to make changes without further notice to any products herein. SCILLC makes no warranty, representation or guarantee regarding the suitability of its products for any particular purpose, nor does SCILLC assume any liability arising out of the application or use of any product or circuit, and specifically disclaims any and all liability, including without limitation special, consequential or incidental damages. "Typical" parameters which may be provided in SCILLC data sheets and/or specifications can and do vary in different applications and actual performance may vary over time. All operating parameters, including "Typicals" must be validated for each customer application by customer's technical experts. SCILLC does not convey any license under its patent rights nor the rights of others. SCILLC products are not designed, intended, or authorized for use as components in systems intended for surgical implant into the body, or other applications intended to support or sustain life, or for any other application in which the failure of the SCILLC product could create a situation where personal injury or death may occur. Should Buyer purchase or use SCILLC products for any such unintended or unauthorized application, Buyer shall indemnify and hold SCILLC and its officers, employees, subsidiaries, affiliates, and distributors harmless against all claims, costs, damages, and expenses, and reasonable attorney fees arising out of, directly or indirectly, any claim of personal injury or death associated with such unintended or unauthorized use, even if such claim alleges that SCILLC was negligent regarding the design or manufacture of the part. SCILLC is an Equal Opportunity/Affirmative Action Employer.

## PUBLICATION ORDERING INFORMATION

**USA/EUROPE Literature Fulfillment:**  
 Literature Distribution Center for ON Semiconductor  
 P.O. Box 5163, Denver, Colorado 80217 USA  
**Phone:** 303-675-2175 or 800-344-3860 Toll Free USA/Canada  
**Fax:** 303-675-2176 or 800-344-3867 Toll Free USA/Canada  
**Email:** ONlit@hibbertco.com

**Fax Response Line\*:** 303-675-2167  
 800-344-3810 Toll Free USA/Canada  
 \*To receive a Fax of our publications

**N. America Technical Support:** 800-282-9855 Toll Free USA/Canada

**ASIA/PACIFIC:** LDC for ON Semiconductor – Asia Support  
**Phone:** 303-675-2121 (Tue-Fri 9:00am to 1:00pm, Hong Kong Time)  
**Email:** ONlit-asia@hibbertco.com

**JAPAN:** ON Semiconductor, Japan Customer Focus Center  
 4-32-1 Nishi-Gotanda, Shinagawa-ku, Tokyo, Japan 141-8549  
**Phone:** 81-3-5487-8345  
**Email:** r14153@onsemi.com

**ON Semiconductor Website:** <http://onsemi.com>

For additional information, please contact your local Sales Representative.