

Designer's™ Data Sheet
**Insulated Gate Bipolar Transistor
with Anti-Parallel Diode**
N-Channel Enhancement-Mode Silicon Gate

This Insulated Gate Bipolar Transistor (IGBT) is co-packaged with a soft recovery ultra-fast rectifier and uses an advanced termination scheme to provide an enhanced and reliable high voltage-blocking capability. Its new 600 V IGBT technology is specifically suited for applications requiring both a high temperature short circuit capability and a low $V_{CE(on)}$. It also provides fast switching characteristics and results in efficient operation at high frequencies. Co-packaged IGBTs save space, reduce assembly time and cost. This new E-series introduces an energy efficient, ESD protected and short circuit rugged device.

- Industry Standard TO-220 Package
- High Speed: $E_{off} = 60 \mu\text{J/A}$ typical at 125°C
- High Voltage Short Circuit Capability – 10 μs minimum at 125°C, 400 V
- Low On-Voltage 2.0 V typical at 3.0 A, 125°C
- Soft Recovery Free Wheeling Diode is Included in the Package
- Robust High Voltage Termination
- ESD Protection Gate-Emitter Zener Diodes

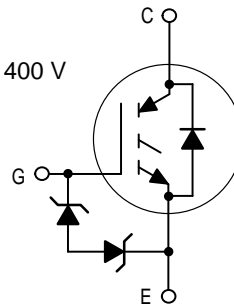

MGP4N60ED

IGBT & DIODE IN TO-220
4.0 A @ 90°C
6.0 A @ 25°C
600 VOLTS
SHORT CIRCUIT RATED
LOW ON-VOLTAGE

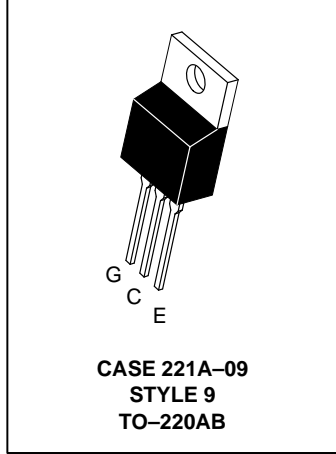

MAXIMUM RATINGS ($T_J = 25^\circ\text{C}$ unless otherwise noted)

Rating	Symbol	Value	Unit
Collector-Emitter Voltage	V_{CES}	600	Vdc
Collector-Gate Voltage ($R_{GE} = 1.0 \text{ M}\Omega$)	V_{CGR}	600	Vdc
Gate-Emitter Voltage — Continuous	V_{GE}	± 20	Vdc
Collector Current — Continuous @ $T_C = 25^\circ\text{C}$ — Continuous @ $T_C = 90^\circ\text{C}$ — Repetitive Pulsed Current (1)	I_{C25} I_{C90} I_{CM}	6.0 4.0 8.0	Adc Apk
Total Power Dissipation @ $T_C = 25^\circ\text{C}$ Derate above 25°C	P_D	62.5 0.51	Watts W/°C
Operating and Storage Junction Temperature Range	T_J, T_{stg}	-55 to 150	°C
Short Circuit Withstand Time ($V_{CC} = 400 \text{ Vdc}, V_{GE} = 15 \text{ Vdc}, T_J = 125^\circ\text{C}, R_G = 20 \Omega$)	t_{sc}	10	μs
Thermal Resistance — Junction to Case – IGBT — Junction to Case – Diode — Junction to Ambient	$R_{\theta JC}$ $R_{\theta J C}$ $R_{\theta JA}$	2.0 3.6 65	°C/W
Maximum Lead Temperature for Soldering Purposes, 1/8" from case for 5 seconds	T_L	260	°C
Mounting Torque, 6-32 or M3 screw	10 lbf•in (1.13 N•m)		

(1) Pulse width is limited by maximum junction temperature. Repetitive rating.
Designer's Data for "Worst Case" Conditions — The Designer's Data Sheet permits the design of most circuits entirely from the information presented. SOA Limit curves — representing boundaries on device characteristics — are given to facilitate "worst case" design.
Designer's™ is a trademark of Motorola, Inc.

MGP4N60ED

ELECTRICAL CHARACTERISTICS (T_J = 25°C unless otherwise noted)

Characteristic	Symbol	Min	Typ	Max	Unit
OFF CHARACTERISTICS					
Collector-to-Emitter Breakdown Voltage (V _{GE} = 0 Vdc, I _C = 25 μAdc) Temperature Coefficient (Positive)	V _{(BR)CES}	600 —	— 870	— —	Vdc mV/°C
Zero Gate Voltage Collector Current (V _{CE} = 600 Vdc, V _{GE} = 0 Vdc) (V _{CE} = 600 Vdc, V _{GE} = 0 Vdc, T _J = 125°C)	I _{CES}	— —	— —	10 200	μAdc
Gate-Body Leakage Current (V _{GE} = ± 20 Vdc, V _{CE} = 0 Vdc)	I _{GES}	—	—	50	μAdc

ON CHARACTERISTICS (1)

Collector-to-Emitter On-State Voltage (V _{GE} = 15 Vdc, I _C = 1.5 Adc) (V _{GE} = 15 Vdc, I _C = 1.5 Adc, T _J = 125°C) (V _{GE} = 15 Vdc, I _C = 3.0 Adc)	V _{CE(on)}	— — —	1.6 1.5 2.0	1.9 — 2.4	Vdc
Gate Threshold Voltage (V _{CE} = V _{GE} , I _C = 1.0 mAdc) Threshold Temperature Coefficient (Negative)	V _{GE(th)}	4.0 —	6.0 10	8.0 —	Vdc mV/°C
Forward Transconductance (V _{CE} = 10 Vdc, I _C = 3.0 Adc)	g _{fe}	—	1.8	—	Mhos

DYNAMIC CHARACTERISTICS

Input Capacitance	(V _{CE} = 25 Vdc, V _{GE} = 0 Vdc, f = 1.0 MHz)	C _{ies}	—	342	—	pF
Output Capacitance		C _{oes}	—	40	—	
Transfer Capacitance		C _{res}	—	3.0	—	

SWITCHING CHARACTERISTICS (1)

Turn-On Delay Time	(V _{CC} = 360 Vdc, I _C = 3.0 Adc, V _{GE} = 15 Vdc, L = 300 μH, R _G = 20 Ω) Energy losses include "tail"	t _{d(on)}	—	34	—	ns	
Rise Time		t _r	—	30	—		
Turn-Off Delay Time		t _{d(off)}	—	36	—		
Fall Time			t _f	—	216	—	μJ
Turn-Off Switching Loss		E _{off}	—	100	150		
Turn-On Switching Loss		E _{on}	—	25	—		
Total Switching Loss		E _{ts}	—	125	—		
Turn-On Delay Time	(V _{CC} = 360 Vdc, I _C = 3.0 Adc, V _{GE} = 15 Vdc, L = 300 μH, R _G = 20 Ω, T _J = 125°C) Energy losses include "tail"	t _{d(on)}	—	33	—	ns	
Rise Time		t _r	—	32	—		
Turn-Off Delay Time		t _{d(off)}	—	56	—		
Fall Time			t _f	—	340	—	μJ
Turn-Off Switching Loss		E _{off}	—	170	—		
Turn-On Switching Loss		E _{on}	—	50	—		
Total Switching Loss		E _{ts}	—	220	—		
Gate Charge	(V _{CC} = 360 Vdc, I _C = 3.0 Adc, V _{GE} = 15 Vdc)	Q _T	—	18.1	—	nC	
		Q ₁	—	3.8	—		
		Q ₂	—	7.8	—		

(1) Pulse Test: Pulse Width ≤ 300 μs, Duty Cycle ≤ 2%.

DIODE CHARACTERISTICS

Diode Forward Voltage Drop ($I_{EC} = 1.25 \text{ Adc}$) ($I_{EC} = 1.25 \text{ Adc}, T_J = 125^\circ\text{C}$) ($I_{EC} = 2.5 \text{ Adc}$)		V_{FEC}	—	1.7	—	Vdc
			—	1.3	—	
			—	2.0	2.3	
Reverse Recovery Time	(I _F = 2.5 Adc, V _R = 360 Vdc, dI _F /dt = 200 A/μs)	t _{rr}	—	39	—	ns
		t _a	—	15	—	
		t _b	—	24	—	
Reverse Recovery Stored Charge		Q _{RR}	—	51	—	nC
Reverse Recovery Time	(I _F = 2.5 Adc, V _R = 360 Vdc, dI _F /dt = 200 A/μs, T _J = 125°C)	t _{rr}	—	68	—	ns
		t _a	—	21	—	
		t _b	—	47	—	
Reverse Recovery Stored Charge		Q _{RR}	—	115	—	nC

INTERNAL PACKAGE INDUCTANCE

Internal Emitter Inductance (Measured from the emitter lead 0.25" from package to emitter bond pad)	L _E	—	7.5	—	nH
--	----------------	---	-----	---	----

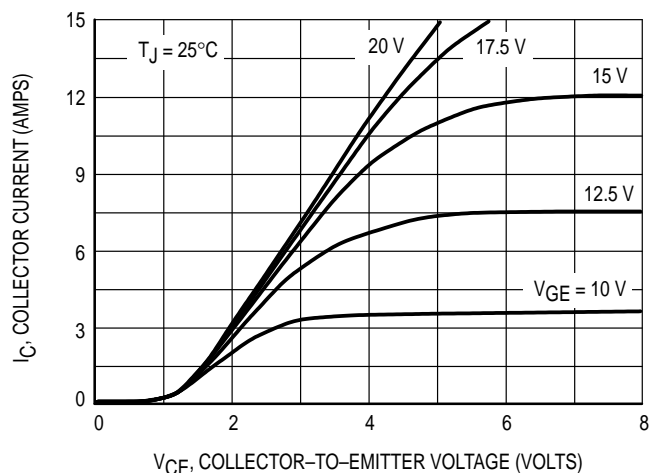

Figure 1. Output Characteristics

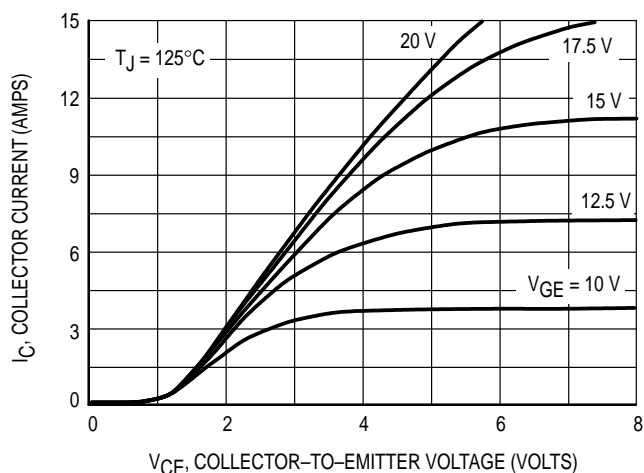

Figure 2. Output Characteristics

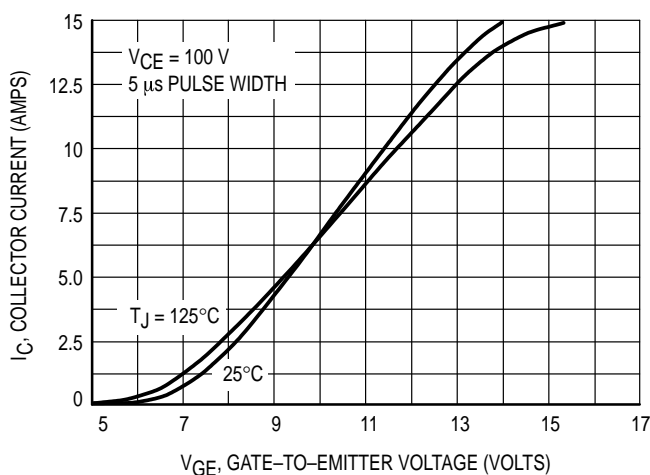

Figure 3. Transfer Characteristics

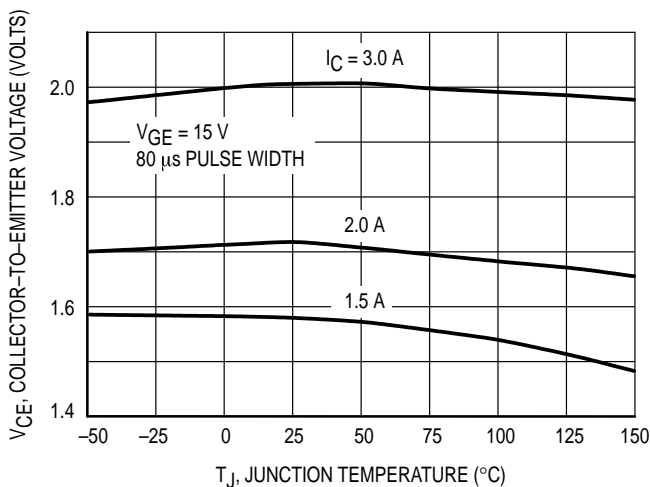

Figure 4. Collector-To-Emitter Saturation Voltage versus Junction Temperature

MGP4N60ED

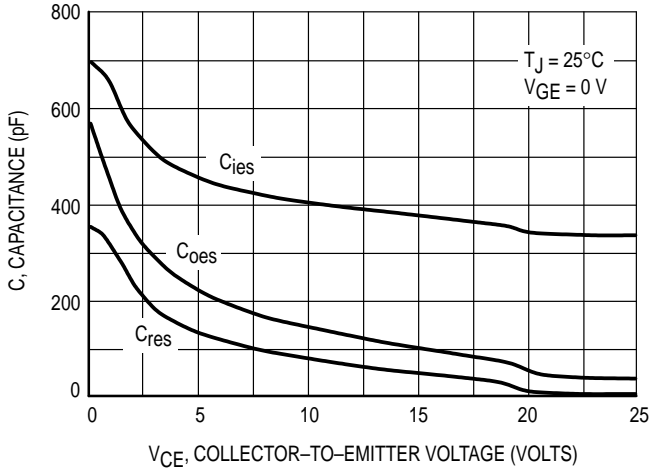

Figure 5. Capacitance Variation

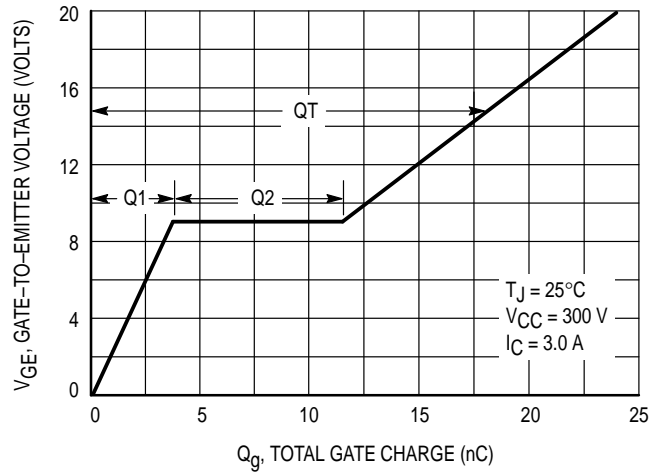

Figure 6. Gate-To-Emitter Voltage versus Total Charge

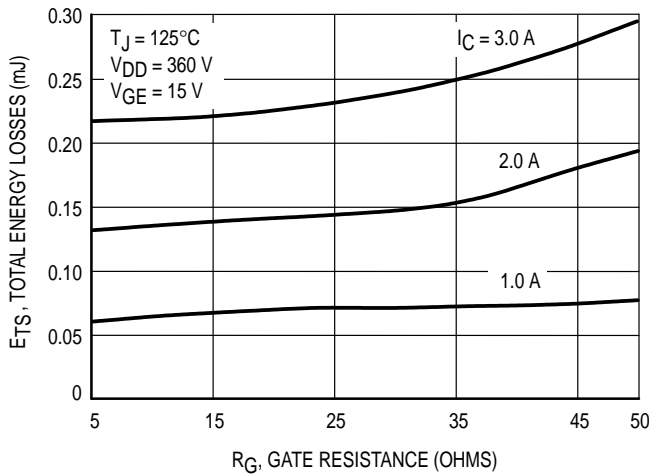

Figure 7. Total Energy Losses versus Gate Resistance

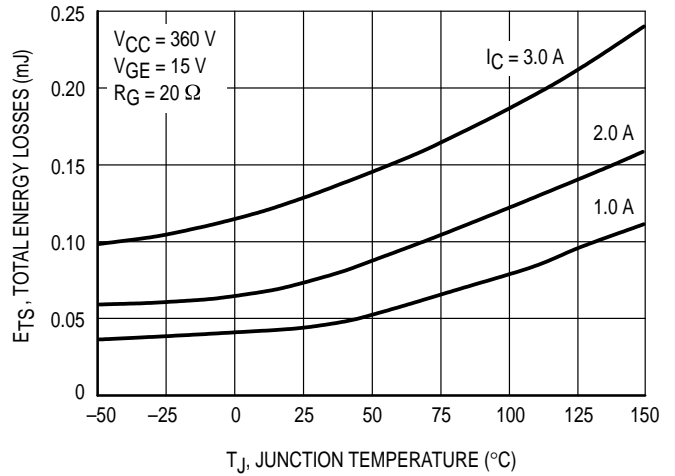

Figure 8. Total Energy Losses versus Junction Temperature

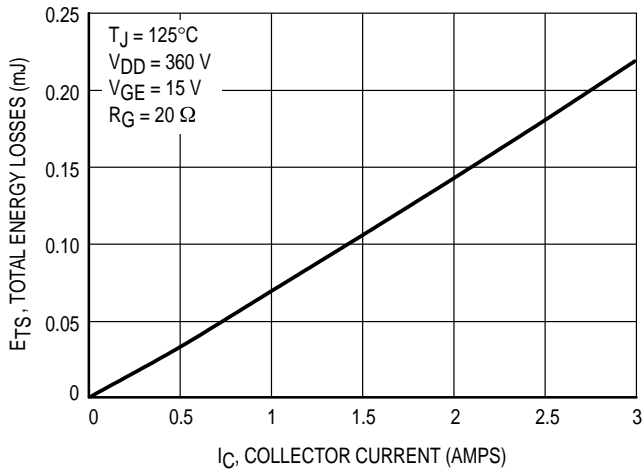

Figure 9. Total Energy Losses versus Collector Current

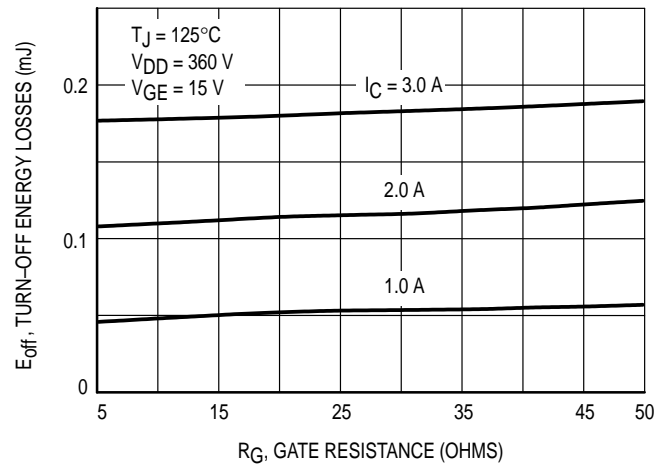

Figure 10. Turn-Off Losses versus Gate Resistance

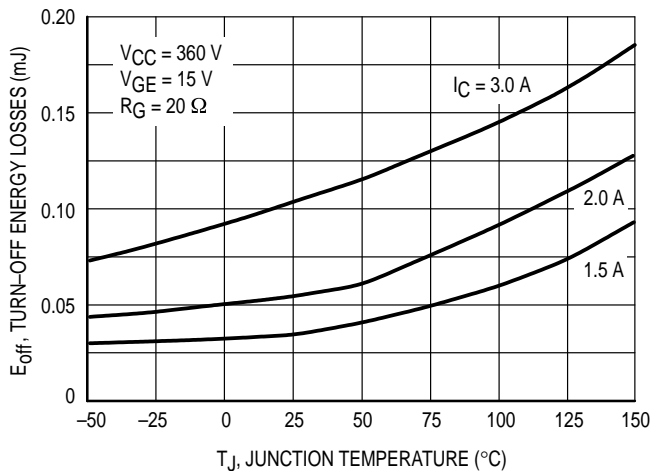

Figure 11. Turn-Off Losses versus Junction Temperature

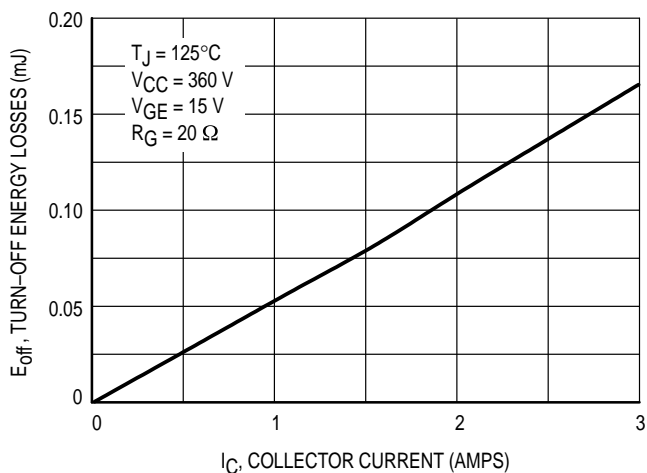

Figure 12. Turn-Off Losses versus Collector Current

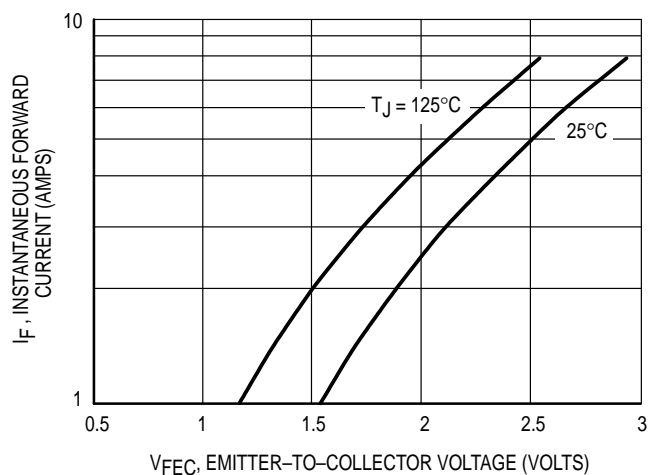

Figure 13. Forward Characteristics versus Current

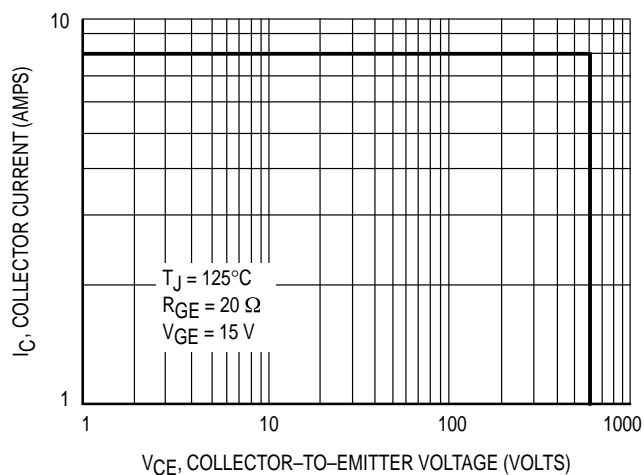
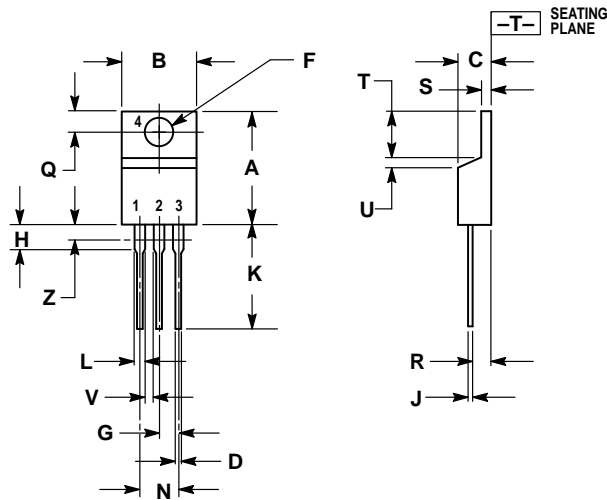

Figure 14. Reverse Biased Safe Operating Area

PACKAGE DIMENSIONS



- NOTES:
1. DIMENSIONING AND TOLERANCING PER ANSI Y14.5M, 1982.
 2. CONTROLLING DIMENSION: INCH.
 3. DIMENSION Z DEFINES A ZONE WHERE ALL BODY AND LEAD IRREGULARITIES ARE ALLOWED.

DIM	INCHES		MILLIMETERS	
	MIN	MAX	MIN	MAX
A	0.570	0.620	14.48	15.75
B	0.380	0.405	9.66	10.28
C	0.160	0.190	4.07	4.82
D	0.025	0.035	0.64	0.88
F	0.142	0.147	3.61	3.73
G	0.095	0.105	2.42	2.66
H	0.110	0.155	2.80	3.93
J	0.018	0.025	0.46	0.64
K	0.500	0.562	12.70	14.27
L	0.045	0.060	1.15	1.52
N	0.190	0.210	4.83	5.33
Q	0.100	0.120	2.54	3.04
R	0.080	0.110	2.04	2.79
S	0.045	0.055	1.15	1.39
T	0.235	0.255	5.97	6.47
U	0.000	0.050	0.00	1.27
V	0.045	—	1.15	—
Z	—	0.080	—	2.04

- STYLE 9:
 PIN 1. GATE
 2. COLLECTOR
 3. EMITTER
 4. COLLECTOR

CASE 221A-09
 TO-220AB
 ISSUE Z

Motorola reserves the right to make changes without further notice to any products herein. Motorola makes no warranty, representation or guarantee regarding the suitability of its products for any particular purpose, nor does Motorola assume any liability arising out of the application or use of any product or circuit, and specifically disclaims any and all liability, including without limitation consequential or incidental damages. "Typical" parameters which may be provided in Motorola data sheets and/or specifications can and do vary in different applications and actual performance may vary over time. All operating parameters, including "Typicals" must be validated for each customer application by customer's technical experts. Motorola does not convey any license under its patent rights nor the rights of others. Motorola products are not designed, intended, or authorized for use as components in systems intended for surgical implant into the body, or other applications intended to support or sustain life, or for any other application in which the failure of the Motorola product could create a situation where personal injury or death may occur. Should Buyer purchase or use Motorola products for any such unintended or unauthorized application, Buyer shall indemnify and hold Motorola and its officers, employees, subsidiaries, affiliates, and distributors harmless against all claims, costs, damages, and expenses, and reasonable attorney fees arising out of, directly or indirectly, any claim of personal injury or death associated with such unintended or unauthorized use, even if such claim alleges that Motorola was negligent regarding the design or manufacture of the part. Motorola and  are registered trademarks of Motorola, Inc. Motorola, Inc. is an Equal Opportunity/Affirmative Action Employer.

Mfax is a trademark of Motorola, Inc.

How to reach us:

USA/EUROPE/Locations Not Listed: Motorola Literature Distribution;
 P.O. Box 5405, Denver, Colorado 80217. 1-303-675-2140 or 1-800-441-2447

JAPAN: Nippon Motorola Ltd.: SPD, Strategic Planning Office, 141,
 4-32-1 Nishi-Gotanda, Shagawa-ku, Tokyo, Japan. 03-5487-8488

Customer Focus Center: 1-800-521-6274

Mfax™: RMFAX0@email.sps.mot.com – TOUCHTONE 1-602-244-6609
 Motorola Fax Back System – US & Canada ONLY 1-800-774-1848
 –http://sps.motorola.com/mfax/

ASIA/PACIFIC: Motorola Semiconductors H.K. Ltd.; 8B Tai Ping Industrial Park,
 51 Ting Kok Road, Tai Po, N.T., Hong Kong. 852-26629298

HOME PAGE: <http://motorola.com/sps/>

