

# MKP9V160

Preferred Device

## Sidac High Voltage

### Bidirectional Triggers

Bidirectional devices designed for direct interface with the ac power line. Upon reaching the breakover voltage in each direction, the device switches from a blocking state to a low voltage on-state. Conduction will continue like a Triac until the main terminal current drops below the holding current. The plastic axial lead package provides high pulse current capability at low cost. Glass passivation insures reliable operation.

#### Features

- High Pressure Sodium Vapor Lighting
- Strobes and Flashers
- Igniters
- High Voltage Regulators
- Pulse Generators
- Used to Trigger Gates of SCR's and Triacs
- $\mathcal{N}$  Indicates UL Registered – File #E116110
- Pb-Free Package is Available

#### MAXIMUM RATINGS ( $T_J = 25^\circ\text{C}$ unless otherwise noted)

Rating	Symbol	Value	Unit
Peak Repetitive Off-State Voltage (Sine Wave, 50 to 60 Hz, $T_J = -40$ to $125^\circ\text{C}$ )	$V_{\text{DRM}}$ , $V_{\text{RRM}}$	$\pm 90$	V
On-State Current RMS ( $T_L = 80^\circ\text{C}$ , Lead Length = $3/8''$ All Conduction Angles)	$I_{\text{T(RMS)}}$	$\pm 0.9$	A
Peak Non-repetitive Surge Current (60 Hz One Cycle Sine Wave, $T_J = 125^\circ\text{C}$ )	$I_{\text{TSM}}$	$\pm 4.0$	A
Operating Junction Temperature Range	$T_J$	$-40$ to $+125$	$^\circ\text{C}$
Storage Temperature Range	$T_{\text{stg}}$	$-40$ to $+150$	$^\circ\text{C}$

#### THERMAL CHARACTERISTICS

Rating	Symbol	Max	Unit
Thermal Resistance, Junction-to-Lead Lead Length = $3/8''$	$R_{\theta\text{JL}}$	40	$^\circ\text{C}/\text{W}$
Lead Solder Temperature (Lead Length $\geq 1/16''$ from Case, 10 s Max)	$T_L$	260	$^\circ\text{C}$

Stresses exceeding Maximum Ratings may damage the device. Maximum Ratings are stress ratings only. Functional operation above the Recommended Operating Conditions is not implied. Extended exposure to stresses above the Recommended Operating Conditions may affect device reliability.

\*For additional information on our Pb-Free strategy and soldering details, please download the ON Semiconductor Soldering and Mounting Techniques Reference Manual, SOLDERRM/D.



ON Semiconductor®

<http://onsemi.com>

**SIDACS ( $\mathcal{N}$ )**  
**0.9 AMPS RMS, 160 VOLTS**

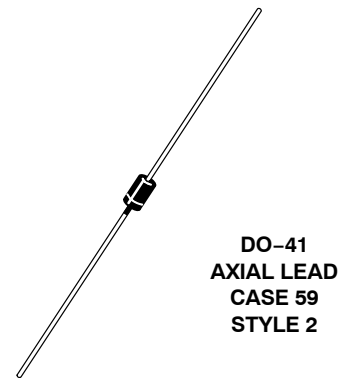

DO-41  
AXIAL LEAD  
CASE 59  
STYLE 2

#### MARKING DIAGRAM



A = Assembly Location  
Y = Year  
WW = Work Week  
▪ = Pb-Free Package  
(Note: Microdot may be in either location)

#### ORDERING INFORMATION

Device	Package	Shipping†
MKP9V160RL	Axial Lead*	5000 Tape & Reel
MKP9V160RLG	Axial Lead*	5000 Tape & Reel

†For information on tape and reel specifications, including part orientation and tape sizes, please refer to our Tape and Reel Packaging Specifications Brochure, BRD8011/D.

Preferred devices are recommended choices for future use and best overall value.

# MKP9V160

## ELECTRICAL CHARACTERISTICS ( $T_C = 25^\circ\text{C}$ unless otherwise noted; Electricals apply in both directions)

Characteristic	Symbol	Min	Typ	Max	Unit
----------------	--------	-----	-----	-----	------

### OFF CHARACTERISTICS

Repetitive Peak Off-State Current (50 to 60 Hz Sine Wave)	$T_J = 25^\circ\text{C}$ $V_{\text{DRM}} = 90\text{ V}$	$I_{\text{DRM}}$	-	-	5.0	$\mu\text{A}$
--	--	------------------	---	---	-----	---------------

### ON CHARACTERISTICS

Breakover Voltage $I_{\text{BO}} = 200\ \mu\text{A}$	$V_{\text{BO}}$	150	-	170	V
Peak On-State Voltage ( $I_{\text{TM}} = 1\text{ A Peak}$ , Pulse Width $\leq 300\ \mu\text{s}$ , Duty Cycle $\leq 2\%$ )	$V_{\text{TM}}$	-	1.3	1.5	V
Dynamic Holding Current (Sine Wave, 50 to 60 Hz, $R_L = 100\ \Omega$ )	$I_{\text{H}}$	-	-	100	mA
Switching Resistance (Sine Wave, 50 to 60 Hz)	$R_S$	0.1	-	-	k $\Omega$

### DYNAMIC CHARACTERISTICS

Critical Rate-of-Rise of On-State Current, Critical Damped Waveform Circuit ( $I_{\text{PK}} = 130\text{ A}$ , Pulse Width = $10\ \mu\text{sec}$ )	$di/dt$	-	120	-	A/ $\mu\text{s}$
--	---------	---	-----	---	------------------

## Voltage Current Characteristic of SIDAC (Bidirectional Device)

Symbol	Parameter
$I_{\text{DRM}}$	Off State Leakage Current
$V_{\text{DRM}}$	Off State Repetitive Blocking Voltage
$V_{\text{BO}}$	Breakover Voltage
$I_{\text{BO}}$	Breakover Current
$I_{\text{H}}$	Holding Current
$V_{\text{TM}}$	On State Voltage
$I_{\text{TM}}$	Peak on State Current

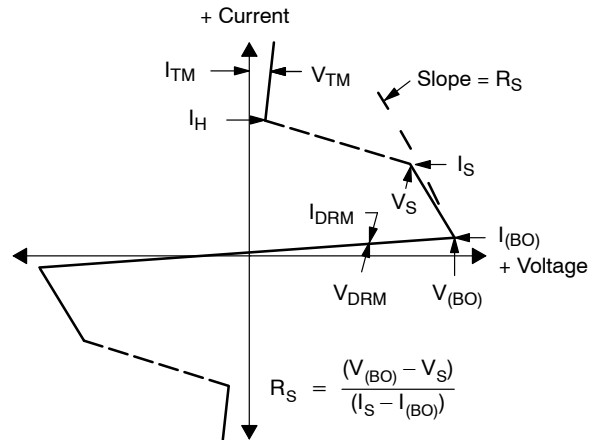

# MKP9V160

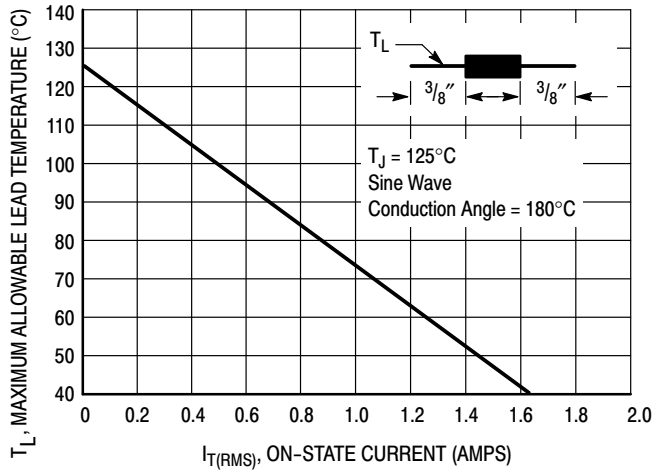

Figure 1. Maximum Lead Temperature

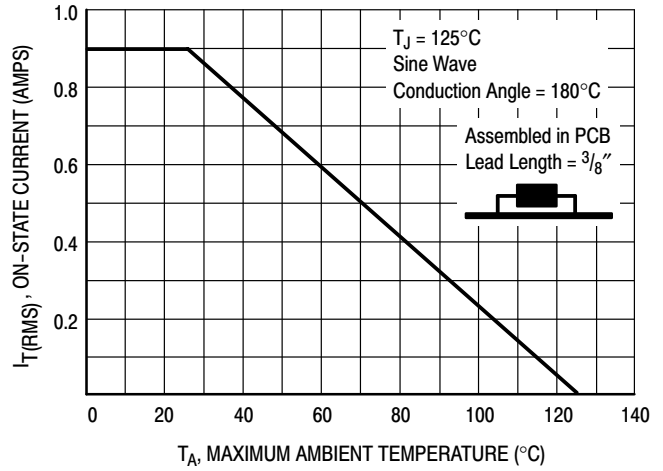

Figure 2. Maximum Ambient Temperature

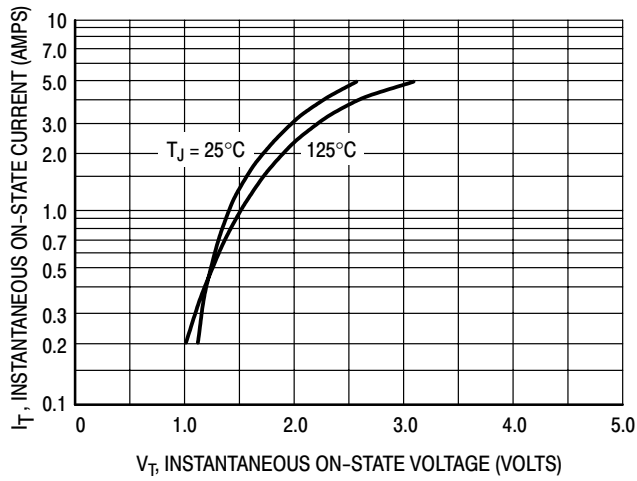

Figure 3. Typical On-State Voltage

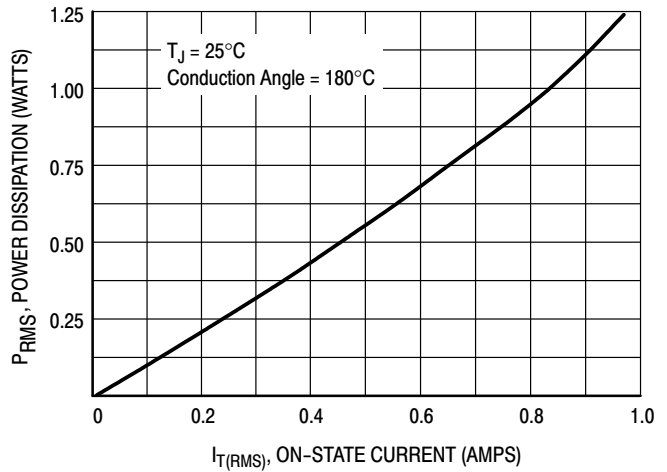

Figure 4. Typical Power Dissipation

## THERMAL CHARACTERISTICS

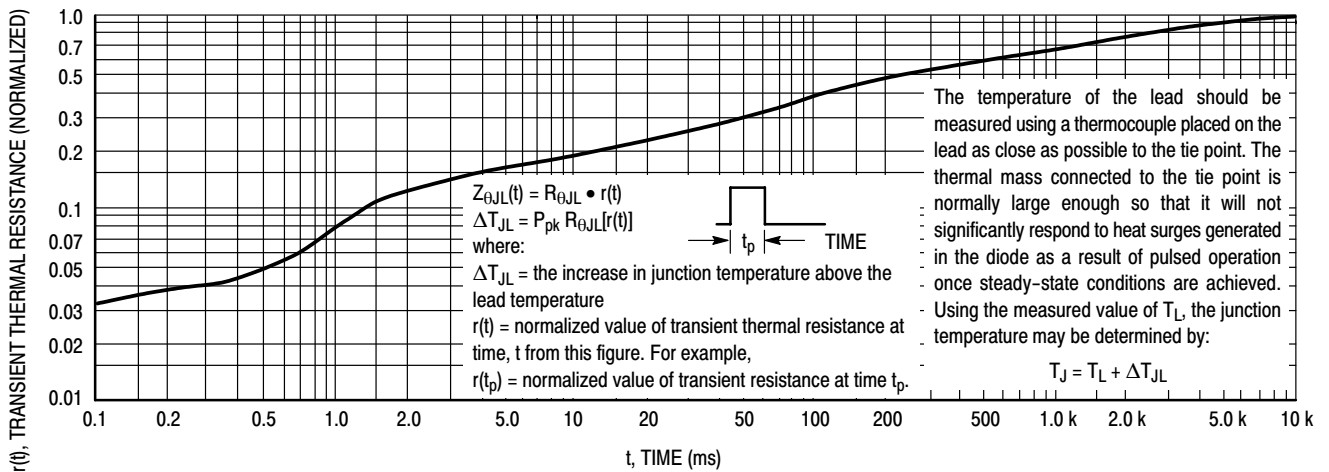

Figure 5. Thermal Response

# MKP9V160

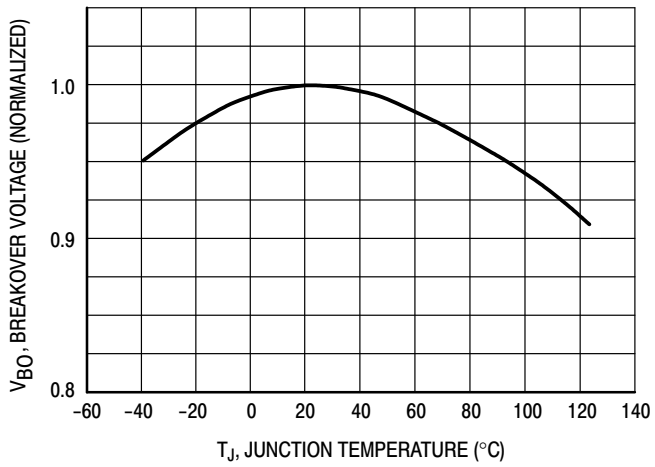

Figure 6. Typical Breakover Voltage

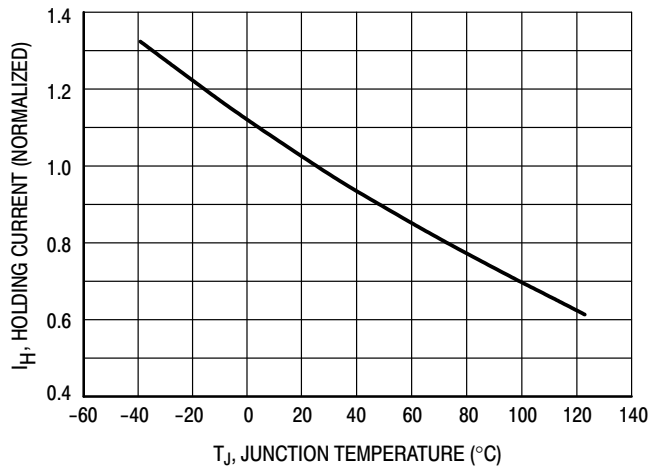

Figure 7. Typical Holding Current

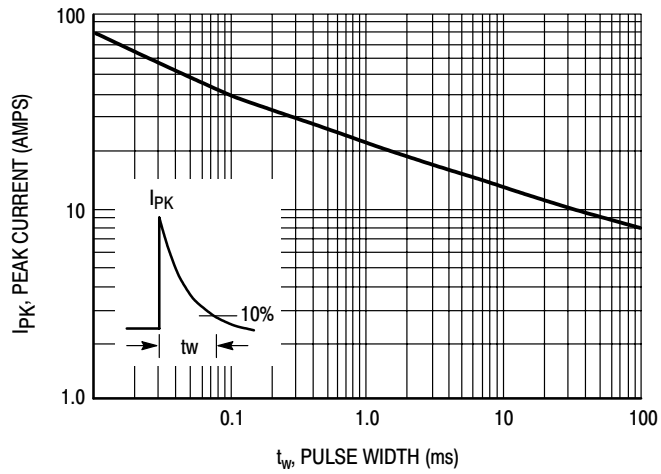
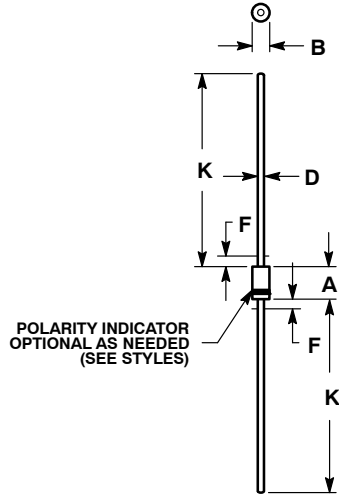

Figure 8. Pulse Rating Curve

# MKP9V160

## PACKAGE DIMENSIONS

### AXIAL LEAD CASE 59-10 ISSUE U



#### NOTES:

1. DIMENSIONING AND TOLERANCING PER ANSI Y14.5M, 1982.
2. CONTROLLING DIMENSION: INCH.
3. ALL RULES AND NOTES ASSOCIATED WITH JEDEC DO-41 OUTLINE SHALL APPLY
4. POLARITY DENOTED BY CATHODE BAND.
5. LEAD DIAMETER NOT CONTROLLED WITHIN F DIMENSION.

DIM	INCHES		MILLIMETERS	
	MIN	MAX	MIN	MAX
A	0.161	0.205	4.10	5.20
B	0.079	0.106	2.00	2.70
D	0.028	0.034	0.71	0.86
F	---	0.050	---	1.27
K	1.000	---	25.40	---

#### STYLE 2:

NO POLARITY

ON Semiconductor and  are registered trademarks of Semiconductor Components Industries, LLC (SCILLC). SCILLC reserves the right to make changes without further notice to any products herein. SCILLC makes no warranty, representation or guarantee regarding the suitability of its products for any particular purpose, nor does SCILLC assume any liability arising out of the application or use of any product or circuit, and specifically disclaims any and all liability, including without limitation special, consequential or incidental damages. "Typical" parameters which may be provided in SCILLC data sheets and/or specifications can and do vary in different applications and actual performance may vary over time. All operating parameters, including "Typicals" must be validated for each customer application by customer's technical experts. SCILLC does not convey any license under its patent rights nor the rights of others. SCILLC products are not designed, intended, or authorized for use as components in systems intended for surgical implant into the body, or other applications intended to support or sustain life, or for any other application in which the failure of the SCILLC product could create a situation where personal injury or death may occur. Should Buyer purchase or use SCILLC products for any such unintended or unauthorized application, Buyer shall indemnify and hold SCILLC and its officers, employees, subsidiaries, affiliates, and distributors harmless against all claims, costs, damages, and expenses, and reasonable attorney fees arising out of, directly or indirectly, any claim of personal injury or death associated with such unintended or unauthorized use, even if such claim alleges that SCILLC was negligent regarding the design or manufacture of the part. SCILLC is an Equal Opportunity/Affirmative Action Employer. This literature is subject to all applicable copyright laws and is not for resale in any manner.

#### PUBLICATION ORDERING INFORMATION

**LITERATURE FULFILLMENT:**  
Literature Distribution Center for ON Semiconductor  
P.O. Box 61312, Phoenix, Arizona 85082-1312 USA  
**Phone:** 480-829-7710 or 800-344-3860 Toll Free USA/Canada  
**Fax:** 480-829-7709 or 800-344-3867 Toll Free USA/Canada  
**Email:** orderlit@onsemi.com

**N. American Technical Support:** 800-282-9855 Toll Free  
USA/Canada

**Japan:** ON Semiconductor, Japan Customer Focus Center  
2-9-1 Kamimeguro, Meguro-ku, Tokyo, Japan 153-0051  
**Phone:** 81-3-5773-3850

**ON Semiconductor Website:** <http://onsemi.com>

**Order Literature:** <http://www.onsemi.com/litorder>

For additional information, please contact your  
local Sales Representative.