

FM / TV front end

BA4425F

The BA4425F is a monolithic IC designed for FM front end use. It consists of an RF amplifier circuit, mixer circuit, oscillation circuit, and IF buffer amplifier.

●Applications

FM radios
Radio cassette players
Home stereos
Headphone stereos

●Features

- 1) Uses double balance mixer to improve intermodulation characteristics.
- 2) Includes a clamp diode in the mixer output.
- 3) Local oscillation buffer on-chip for improved response to strong input.
- 4) The output impedance of the IF buffer is matched with the ceramic filter impedance at 330Ω.
- 5) Mixer input coupling capacitor included on-chip.
- 6) Includes a feedback capacitor for the local oscillation circuit.
- 7) Reception of VHF terrestrial TV channels is possible.
- 8) Compact SOP 8-pin package.

●Absolute maximum ratings (Ta = 25°C)

Parameter	Symbol	Limits	Unit
Power supply voltage	Vcc	7.0	V
Power dissipation*	Pd	500*	mW
Operating temperature	Topr	-25~+75	°C
Storage temperature	Tstg	-55~+125	°C

* Reduced by 5.0mW for each increase in Ta of 1°C over 25°C.

●Recommended operating conditions (Ta = 25°C)

Parameter	Symbol	Limits	Unit
Power supply voltage*	Vcc	1.6~6.0	V

* For basic operation at Ta = 25°C.

●Block diagram

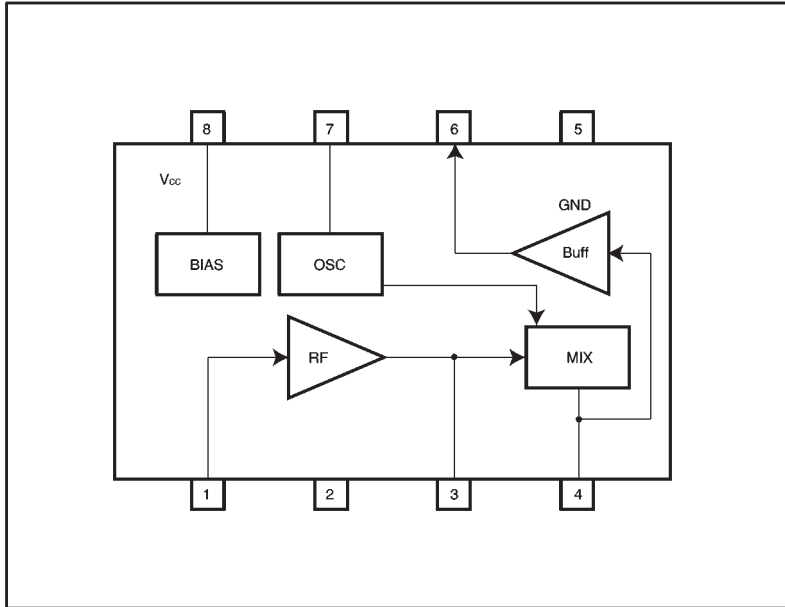

●Pin descriptions

Pin No.	Pin name	Function
1	FM antenna input pin	Connect to BPF, etc. $Z_{IN} = 75 \Omega$
2	RF amplifier bypass pin	Connect to bypass capacitor
3	RF amplifier output load pin	Connect to RF tuning circuit
4	MIX output pin	Connect to IFT or resistor load
5	GND pin	Ground pin of IC
6	IF buffer output pin	$Z_{OUT} = 330 \Omega$
7	OSC pin	Connect to station resonance circuit
8	Vcc pin	Voltage supply pin of IC



●Electrical characteristics (unless otherwise noted, $T_a = 25^\circ\text{C}$ and $V_{CC} = 4.0\text{V}$)

Parameter	Symbol	Min.	Typ.	Max.	Unit	Conditions	Measurement circuit
Quiescent current	I_q	2.6	4.5	7.2	mA	No input	Fig.1
Output saturation voltage	V_o	30	50	72	mV _{rms}	$f_d = 98\text{MHz}$, $80\text{dB } \mu\text{V}$	Fig.1
Local oscillator voltage	V_{osc}	200	400	630	mV _{rms}	$f_{osc} = 108\text{MHz}$, $R_7 = 0 \Omega$	Fig.1
Voltage conversion gain	G_{vc}	31	36	42	dB	$f_d = 98\text{MHz}$, $55\text{dB } \mu\text{V}$	Fig.1
Local oscillation stop voltage	V_{STOP}	—	0.9	1.2	V	$R_7 = 0 \Omega$	Fig.1

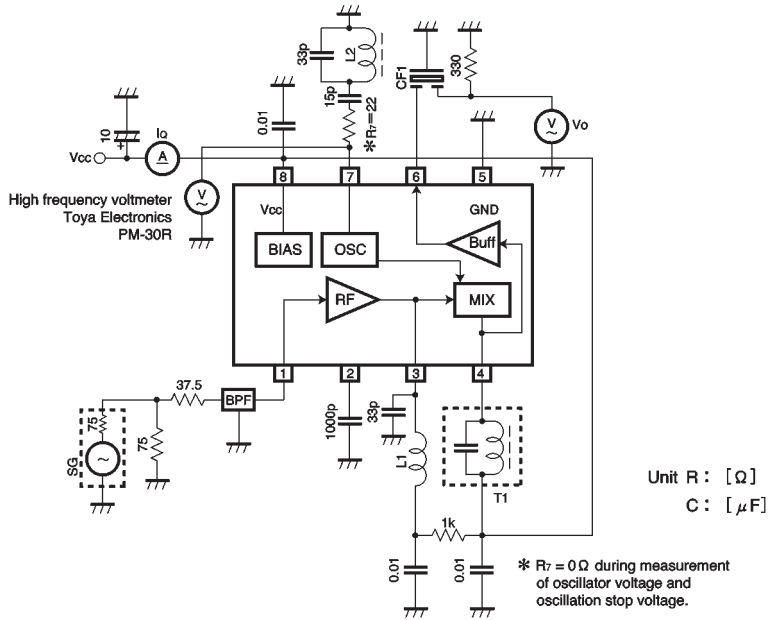
● Measurement circuit

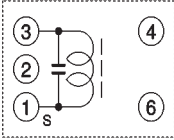

●Component data

Component number	Component name	Product number / manufacturer	Remarks
Z1	Band-pass filter	BPMB6A Soshin	88~108MHz $Z_{in}=75\Omega$, $Z_{out}=75\Omega$
L1	RF coil	FEM10C-2F6 Sumida	 ①-③ $2\frac{1}{2}$ -T Wire type: ϕ 0.6UEW No load: $Q = 115$
L2	OSC coil	FEM10C-2F6 Sumida	 ①-③ $2\frac{1}{2}$ -T Wire type: ϕ 0.6UEW No load: $Q = 115$
T1	IFT	2158-4095-498 Sumida	 ①-③ 13T Wire type: ϕ 0.10UEW Tuning frequency: $10.7\text{ MHz} \pm 3\%$ or higher, variable No load: $Q = 70$ or higher (10.7 MHz) Tuning capacitance: $82\text{pF} \pm 10\%$
CF1	FM ceramic filter	SFE10.7MA5-A Murata	3 dB bandwidth = $280\text{ kHz} \pm 50\text{ kHz}$

●Electrical characteristic curves

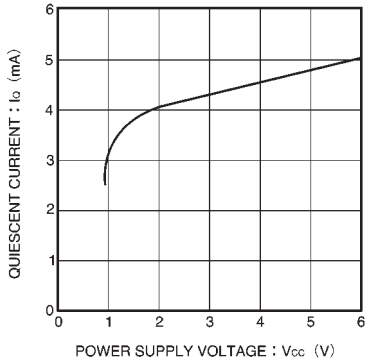

Fig. 1 Quiescent current vs. power supply voltage

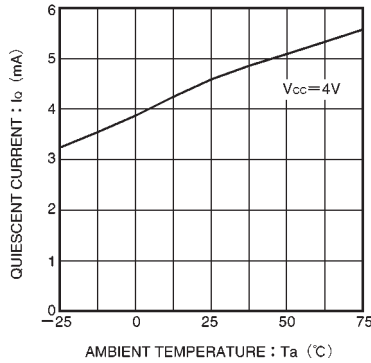

Fig. 2 Quiescent current vs. ambient temperature

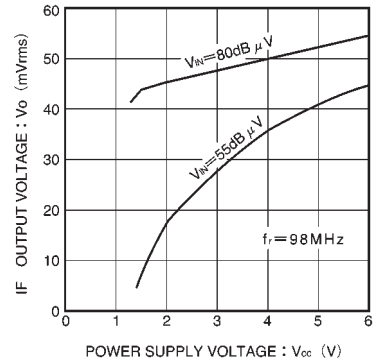

Fig. 3 IF output voltage vs. power supply voltage

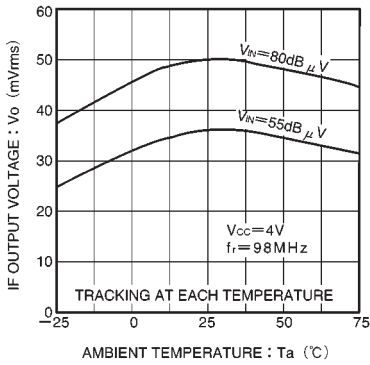

Fig. 4 IF output voltage vs. ambient temperature

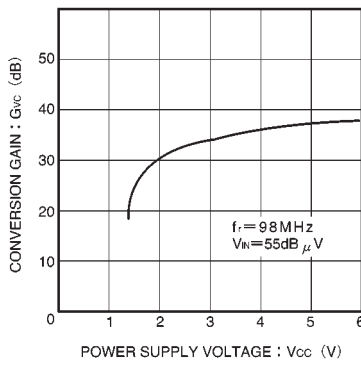

Fig. 5 Voltage conversion gain vs. power supply voltage

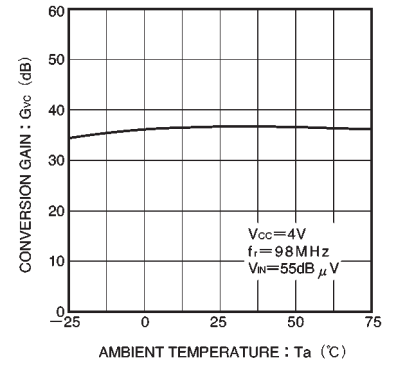

Fig. 6 Voltage conversion gain vs. ambient temperature

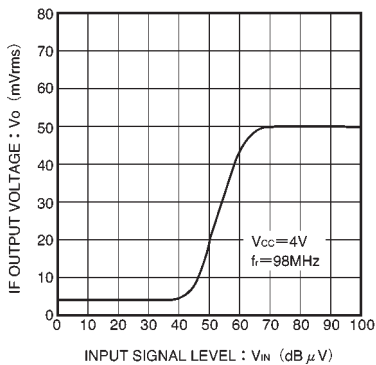

Fig. 7 IF output voltage vs. input signal level

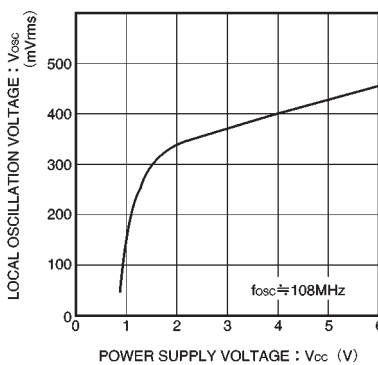

Fig. 8 Local oscillation voltage vs. power supply voltage

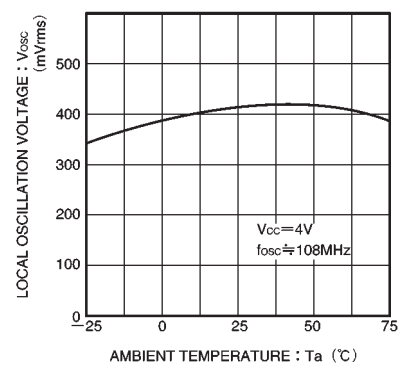

Fig. 9 Local oscillation voltage vs. ambient temperature

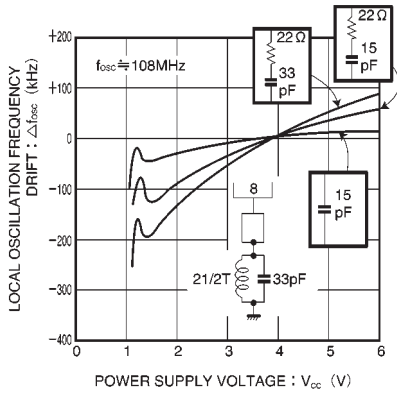

Fig. 10 Local oscillation frequency vs. power supply voltage

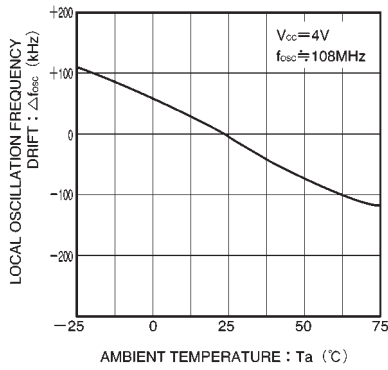

Fig. 11 Local oscillation frequency vs. ambient temperature

● External dimensions (Units: mm)

