



Rated voltage 42 VAC/80 VDC
Rated current 400 to 2500 mA
Rated inductance 0.005 to 4.7 mH



Construction

- Current-compensated ring core choke with ferrite core
- Bifilar winding (B82793C0*/K0*)
- Sector winding (B82793S0*/L0*)

Features

- High rated currents
- Reduced component height
- Case flame-retardant as per UL 94 V-0
- Suitable for reflow soldering

Applications

- B82793C0*/K0*:
Suppression of asymmetrical interference coupled in on lines, whereas data signals up to some MHz can pass unaffectedly.
- B82793S0*/L0*:
Suppression of asymmetrical and symmetrical interference coupled in on lines. The high-frequency portions of the symmetrical data signal are decreased so far that EMC problems can be significantly reduced.
- Industrial applications

Terminals

- Lead-free tinned

Marking

Manufacturer, ordering code (short form),
date of manufacture, coded (year, calendar week, day of week)

Delivery mode

Blister tape, reel packing
For details on taping, packing and packing units see data book 2000 "Chokes and Inductors", page 302.



Dimensional drawing

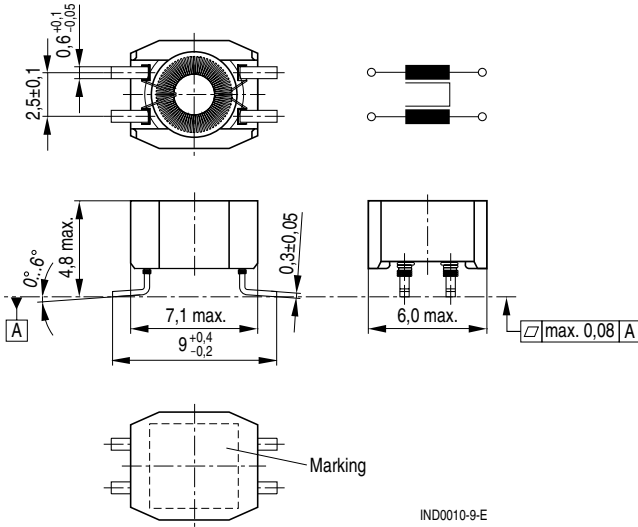

Layout recommendation

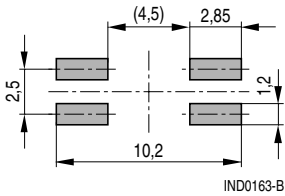

Technical data and measuring conditions

Rated voltage V_R	42 VAC (50/60 Hz) 80 VDC
Rated current I_R	Referred to 50 Hz and 60 °C ambient temperature
Rated inductance L_R (specified per winding)	Measured with HP 4275A Measuring frequency at $L \leq 1\text{mH} = 100\text{ kHz}, 0.1\text{ mA}$ $L > 1\text{ mH} = 10\text{ kHz}, 0.1\text{ mA}$
Inductance tolerance	$L \leq 0.47\text{ mH}: \pm 30\%$ $L > 0.47\text{ mH}: -30/+50\%$
Inductance decrease $\Delta L/L$	<10% at DC magnetic bias with I_R
Stray inductance L_S	Measured with HP 4275A Measuring frequency at $L \leq 11\mu\text{H} = 1\text{ MHz}, 5\text{ mA}$ $L > 11\mu\text{H} = 100\text{ kHz}, 5\text{ mA}$
DC resistance R_{typ}	Typical values, measured at 20 °C ambient temperature
Solderability	215 \pm 3 °C, 3 \pm 0.3 s wetting of soldering area $\geq 95\%$
Climatic category (IEC 60068-1)	40/125/56 (- 40 °C/+125 °C/56 days damp heat test)
Weight	Approx. 0.30 g

Characteristics and ordering codes

L_R mH	L_S, typ nH	$I_R^{1)}$ mA	R_{typ} m Ω	V_{test} VDC, 2 s	Ordering code
0.005	50	1200	100	250	B82793C0502N201
0.006	50	2500	22	250	B82793K0602N201
0.006	400	2500	22	250	B82793L0602N201
0.011	50	800	120	250	B82793C0113N201
0.025	100	800	130	250	B82793C0253N201
0.025	1500	800	130	250	B82793S0253N201
0.051	150	800	160	250	B82793C0513N201
0.051	2000	800	160	250	B82793S0513N201
0.10	180	500	200	250	B82793C0104N201
0.47	200	700	200	750	B82793C0474N215
1.0	250	700	200	750	B82793C0105N265
2.2	250	500	400	750	B82793C0225N265
4.7	300	400	550	750	B82793C0475N265

Sample kit available

Ordering code: B82793X001

1) Types with higher rated current upon request



Insertion loss α_e (typical values at $Z = 50 \Omega$)

- asymmetrical, all branches in parallel (common mode)
- - - - - symmetrical (differential mode)

$L_R = 0.005 \text{ mH}$

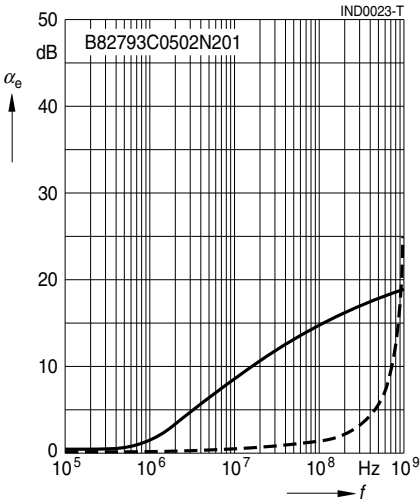

$L_R = 0.006 \text{ mH (low } L_S)$

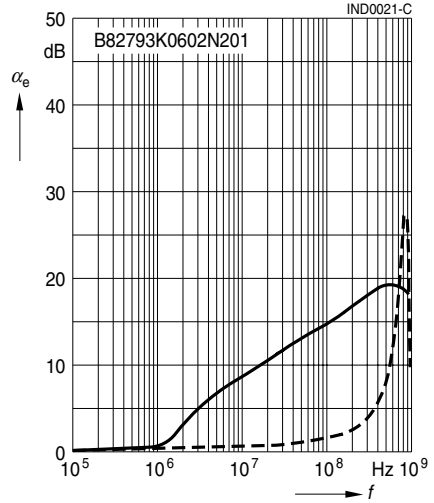

$L_R = 0.006 \text{ mH (high } L_S)$

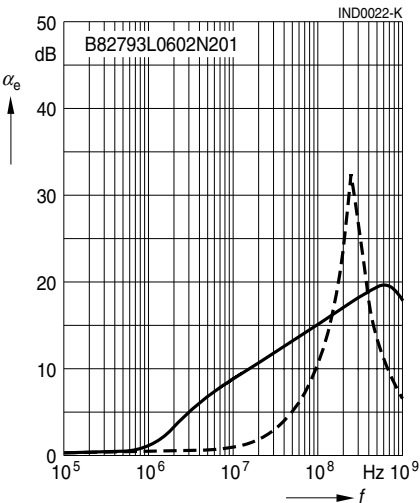

$L_R = 0.011 \text{ mH}$

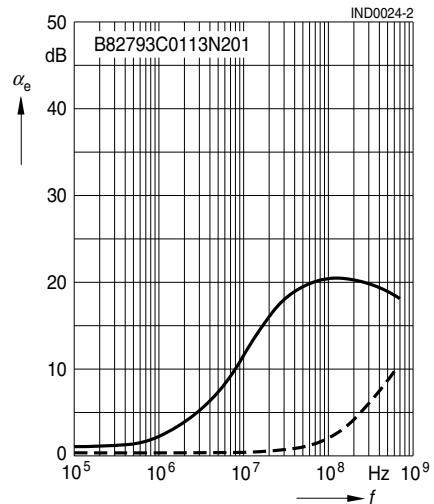



Insertion loss α_e (typical values at $Z = 50 \Omega$)

———— asymmetrical, all branches in parallel (common mode)

- - - - - symmetrical (differential mode)

$L_R = 0.025 \text{ mH}$ (low L_S)

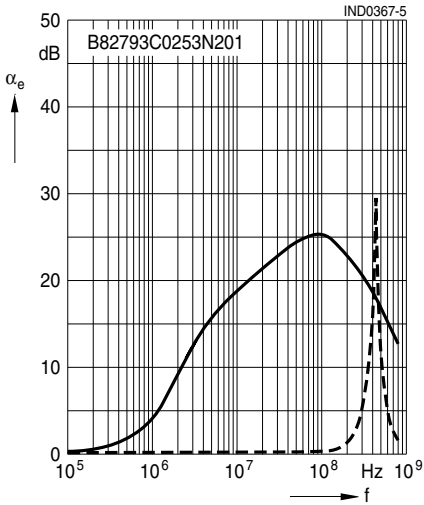

$L_R = 0.025 \text{ mH}$ (high L_S)

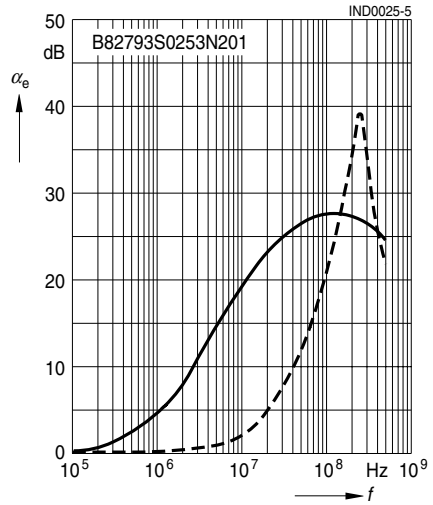

$L_R = 0.051 \text{ mH}$ (low L_S)

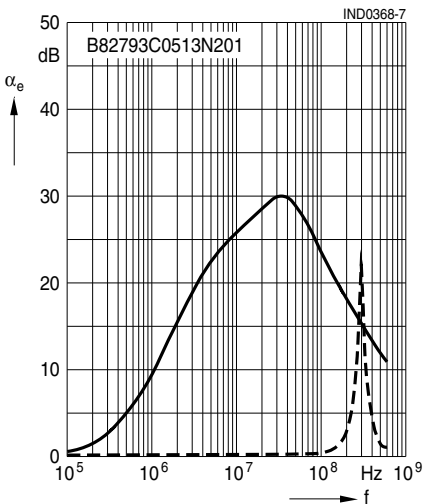

$L_R = 0.051 \text{ mH}$ (high L_S)

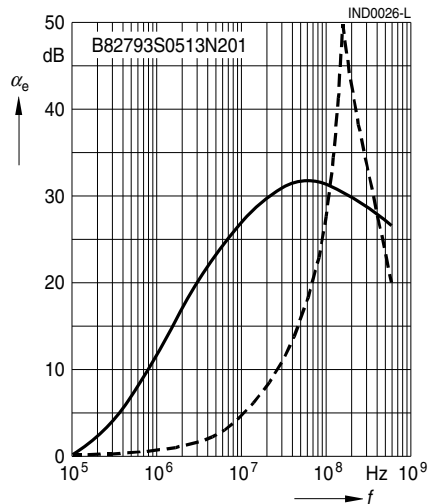



Insertion loss α_e (typical values at $Z = 50 \Omega$)

- asymmetrical, all branches in parallel (common mode)
- - - - - symmetrical (differential mode)

$L_R = 0.10 \text{ mH}$

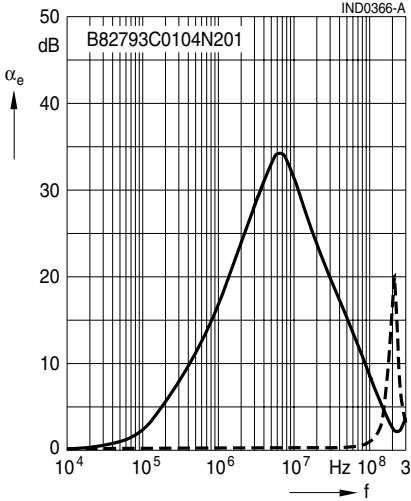

$L_R = 0.47 \text{ mH}$

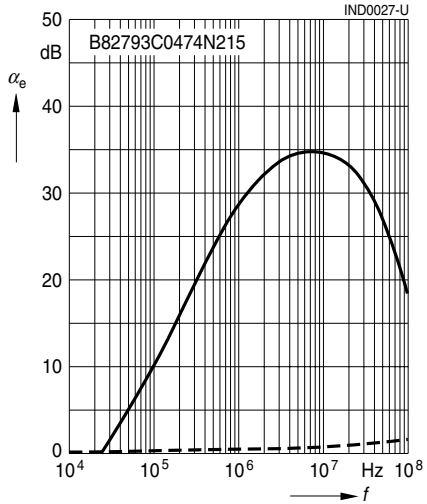

$L_R = 1.0 \text{ mH}$

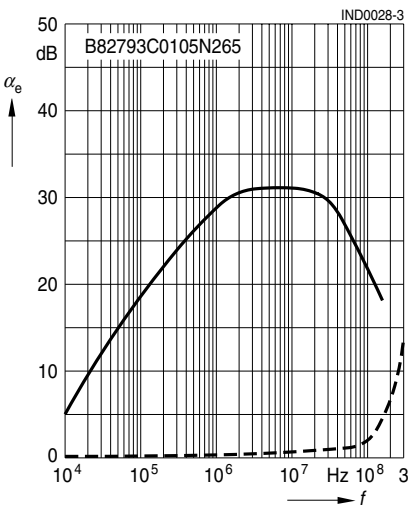

$L_R = 2.2 \text{ mH}$

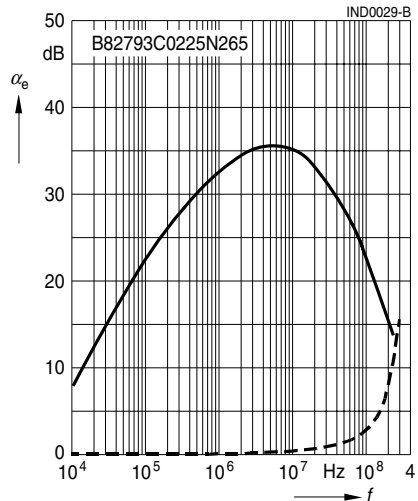



Insertion loss α_e (typical values at $Z = 50 \Omega$)

- asymmetrical, all branches in parallel (common mode)
- - - - - symmetrical (differential mode)

$L_R = 4.7 \text{ mH}$

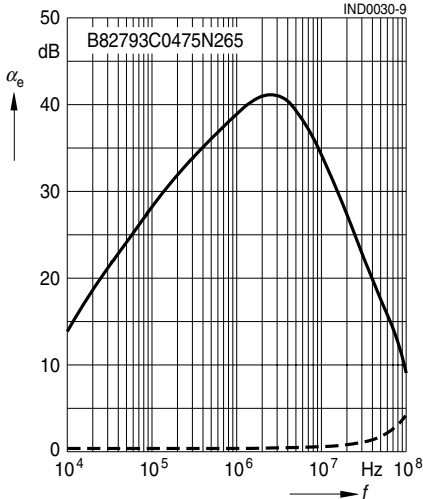

Published by EPCOS AG

Marketing Communications, P.O. Box 80 17 09, 81617 Munich, GERMANY

© EPCOS AG 2004. All Rights Reserved. Reproduction, publication and dissemination of this brochure and the information contained therein without EPCOS' prior express consent is prohibited.

Purchase orders are subject to the General Conditions for the Supply of Products and Services of the Electrical and Electronics Industry recommended by the ZVEI (German Electrical and Electronic Manufacturers' Association), unless otherwise agreed.

This brochure replaces the previous edition.

For questions on technology, prices and delivery please contact the Sales Offices of EPCOS AG or the international Representatives.

Due to technical requirements components may contain dangerous substances. For information on the type in question please also contact one of our Sales Offices.