

GENERAL PURPOSE SINGLE JFET OPERATIONAL AMPLIFIERS

- LOW POWER CONSUMPTION
- WIDE COMMON-MODE (UP TO V_{CC}^+) AND DIFFERENTIAL VOLTAGE RANGE
- LOW INPUT BIAS AND OFFSET CURRENT
- OUTPUT SHORT-CIRCUIT PROTECTION
- HIGH INPUT IMPEDANCE J-FET INPUT STAGE
- INTERNAL FREQUENCY COMPENSATION
- LATCH UP FREE OPERATION
- HIGH SLEW RATE : $16V/\mu s$ (typ)

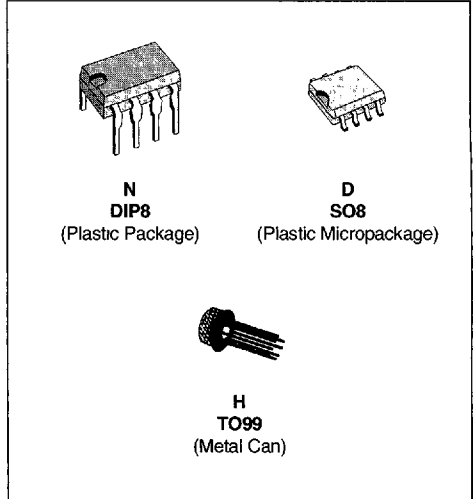

DESCRIPTION

These circuits are high speed J-FET input single operational amplifiers incorporating well matched, high voltage J-FET and bipolar transistors in a monolithic integrated circuit.

The devices feature high slew rates, low input bias and offset current, and low offset voltage temperature coefficient.

ORDER CODES

Part Number	Temperature	Package		
		H	N	D
MC34001/A/B	0°C, +70°C	•	•	•
MC33001/A/B	-40°C, +105°C	•	•	•
MC35001/A/B	-55°C, +125°C	•	•	•

33001-01 TBL

PIN CONNECTIONS (top views)

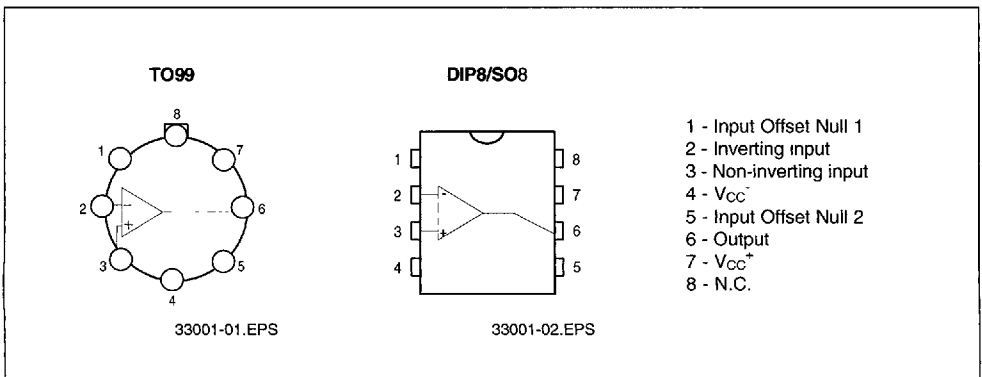

SCHEMATIC DIAGRAM

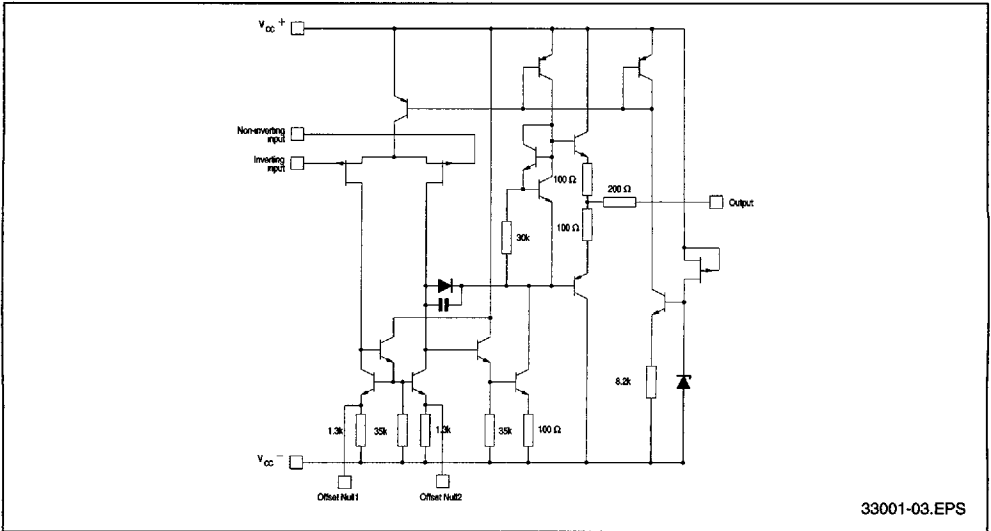

33001-03.EPS

INPUT OFFSET VOLTAGE NULL CIRCUITS

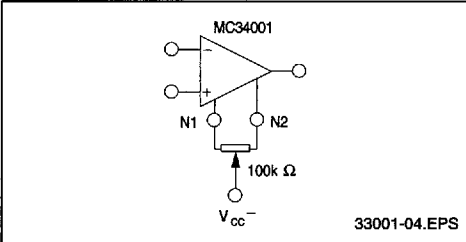

33001-04.EPS

ABSOLUTE MAXIMUM RATINGS

Symbol	Parameter	Value	Unit	
V_{CC}	Supply Voltage - (note 1)	± 18	V	
V_I	Input Voltage - (note 3)	± 15	V	
V_{id}	Differential Input Voltage - (note 2)	± 30	V	
P_{tot}	Power Dissipation	680	mW	
	Output Short-circuit Duration (note 4)	Infinite		
T_{oper}	Operating Free Air Temperature Range	MC34001, A, B MC33001, A, B MC35001, A, B	0 to 70 -40 to 105 -55 to 125	$^{\circ}C$
T_{stg}	Storage Temperature Range		-65 to 150	$^{\circ}C$

- Notes :**
1. All voltage values, except differential voltage, are with respect to the zero reference level (ground) of the supply voltages where the zero reference level is the midpoint between V_{CC}^{+} and V_{CC}^{-} .
 2. Differential voltages are at the non-inverting input terminal with respect to the inverting input terminal.
 3. The magnitude of the input voltage must never exceed the magnitude of the supply voltage or 15 volts, whichever is less.
 4. The output may be shorted to ground or to either supply. Temperature and /or supply voltages must be limited to ensure that the dissipation rating is not exceeded.

ELECTRICAL CHARACTERISTICS

 $V_{CC} = \pm 15V$, $T_{amb} = 25^{\circ}C$ (unless otherwise specified)

Symbol	Parameter	MC35001A,B MC33001A,B MC34001A,B			MC35001 MC33001 MC34001			Unit
		Min.	Typ.	Max.	Min.	Typ.	Max.	
V_{io}	Input Offset Voltage ($R_S \leq 10k\Omega$) $T_{amb} = 25^{\circ}C$ MC35001B, MC34001B, MC33001B MC35001A, MC34001A, MC33001A $T_{min} \leq T_{amb} \leq T_{max}$ MC35001B, MC34001B, MC33001B MC35001A, MC34001A, MC33001A		3 0.4	5 2		3 10		mV
DV_{io}	Input Offset Voltage Drift		10			10		$\mu V/^{\circ}C$
I_{io}	Input Offset Current * $T_{amb} = 25^{\circ}C$ $T_{min} \leq T_{amb} \leq T_{max}$		5	100 4		5 100 4		pA nA
I_{ib}	Input Bias Current * $T_{amb} = 25^{\circ}C$ $T_{min} \leq T_{amb} \leq T_{max}$		20	200 20		20 200 20		pA nA
A_{vd}	Large Signal Voltage Gain ($R_L = 2k\Omega$, $V_O = \pm 10V$) $T_{amb} = 25^{\circ}C$ $T_{min} \leq T_{amb} \leq T_{max}$	50 25	200		25 15	200		V/mV
SVR	Supply Voltage Rejection Ratio ($R_S \leq 10k\Omega$) $T_{amb} = 25^{\circ}C$ $T_{min} \leq T_{amb} \leq T_{max}$	80 80	86		70 70	86		dB
I_{cc}	Supply Current, no Load $T_{amb} = 25^{\circ}C$ $T_{min} \leq T_{amb} \leq T_{max}$		1.4	2.5 2.8		1.4 2.5 2.8		mA
V_{icm}	Input Common Mode Voltage Range	± 11	+15 -12		± 11	+15 -12		V
CMR	Common Mode Rejection Ratio ($R_S \leq 10k\Omega$) $T_{amb} = 25^{\circ}C$ $T_{min} \leq T_{amb} \leq T_{max}$	80 80	86		70 70	86		dB
I_{os}	Output Short-circuit Current $T_{amb} = 25^{\circ}C$ $T_{min} \leq T_{amb} \leq T_{max}$	10 10	40	60 60	10 10	40 60 60		mA
$\pm V_{OPP}$	Output Voltage Swing $T_{amb} = 25^{\circ}C$ $T_{min} \leq T_{amb} \leq T_{max}$		$R_L = 2k\Omega$ 10 12 12 10 12	$R_L = 10k\Omega$ 12 13.5		10 12 13.5 10 12		V
SR	Slew Rate ($V_{in} = 10V$, $R_L = 2k\Omega$, $C_L = 100pF$, $T_{amb} = 25^{\circ}C$, unity gain)	12	16		12	16		V/ μs
t_r	Rise Time ($V_{in} = 20mV$, $R_L = 2k\Omega$, $C_L = 100pF$, $T_{amb} = 25^{\circ}C$, unity gain)		0.1			0.1		μs
K_{OV}	Overshoot ($V_{in} = 20mV$, $R_L = 2k\Omega$, $C_L = 100pF$, $T_{amb} = 25^{\circ}C$, unity gain)		10			10		%
GBP	Gain Bandwidth Product ($f = 100kHz$, $T_{amb} = 25^{\circ}C$, $V_{in} = 10mV$, $R_L = 2k\Omega$, $C_L = 100pF$)	2.5	4		2.5	4		MHz
R_i	Input Resistance		10^{12}			10^{12}		Ω
THD	Total Harmonic Distortion ($f = 1kHz$, $A_V = 20dB$, $R_L = 2k\Omega$, $C_L = 100pF$, $T_{amb} = 25^{\circ}C$, $V_O = 2V_{PP}$)		0.01			0.01		%
e_n	Equivalent Input Noise Voltage ($f = 1kHz$, $R_S = 100\Omega$)		15			15		$\frac{nV}{\sqrt{Hz}}$
ϕ_m	Phase Margin		45			45		Degrees

* The input bias currents are junction leakage currents which approximately double for every $10^{\circ}C$ increase in the junction temperature

MAXIMUM PEAK-TO-PEAK OUTPUT VOLTAGE VERSUS FREQUENCY

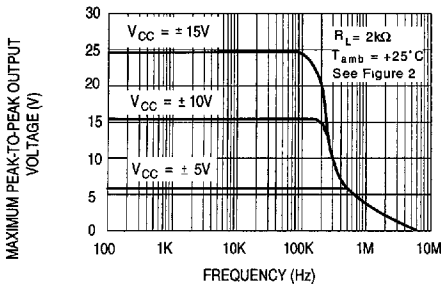

33001-05.EPS

MAXIMUM PEAK-TO-PEAK OUTPUT VOLTAGE VERSUS FREQUENCY

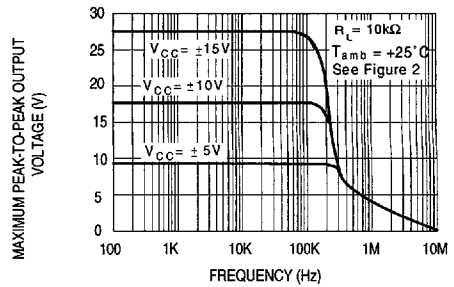

33001-06.EPS

MAXIMUM PEAK-TO-PEAK OUTPUT VOLTAGE VERSUS FREQUENCY

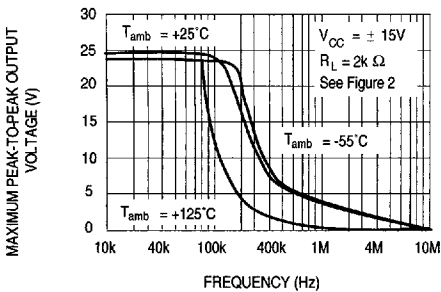

33001-07.EPS

MAXIMUM PEAK-TO-PEAK OUTPUT VOLTAGE VERSUS FREE AIR TEMP.

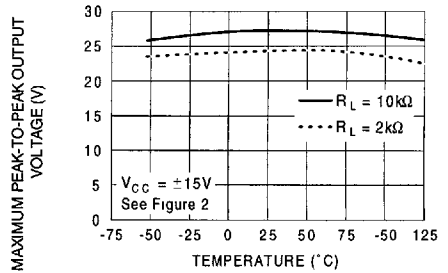

33001-08.EPS

MAXIMUM PEAK-TO-PEAK OUTPUT VOLTAGE VERSUS LOAD RESISTANCE

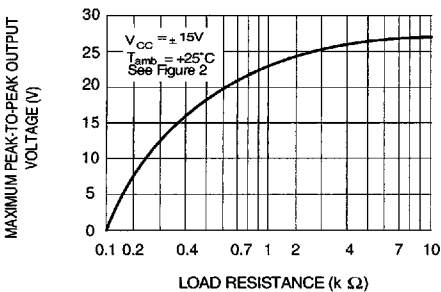

33001-09.EPS

MAXIMUM PEAK-TO-PEAK OUTPUT VOLTAGE VERSUS SUPPLY VOLTAGE

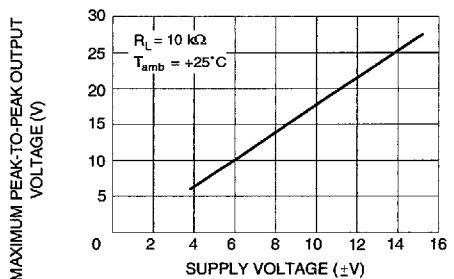

33001-10.EPS

**INPUT BIAS CURRENT VERSUS
FREE AIR TEMPERATURE**

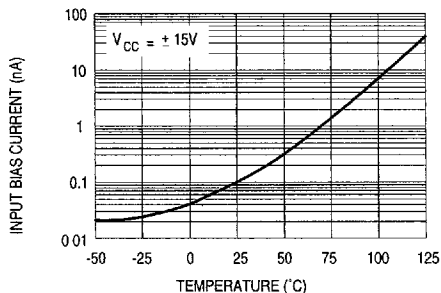

33001-11.EPS

**LARGE SIGNAL DIFFERENTIAL
VOLTAGE AMPLIFICATION VERSUS
FREE AIR TEMPERATURE**

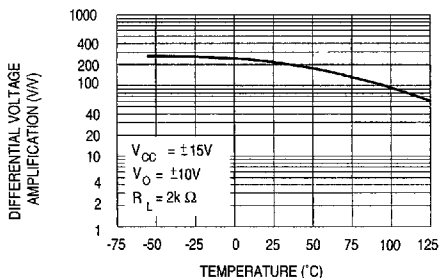

33001-12.EPS

**LARGE SIGNAL DIFFERENTIAL
VOLTAGE AMPLIFICATION AND PHASE
SHIFT VERSUS FREQUENCY**

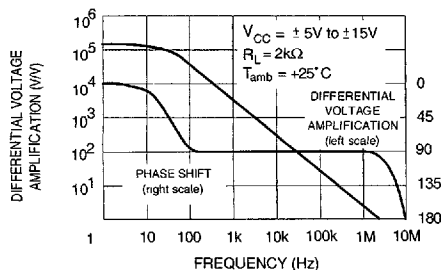

33001-13.EPS

**TOTAL POWER DISSIPATION VERSUS
FREE AIR TEMPERATURE**

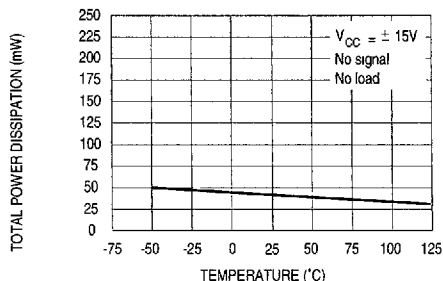

33001-14.EPS

**SUPPLY CURRENT PER AMPLIFIER
VERSUS FREE AIR TEMPERATURE**

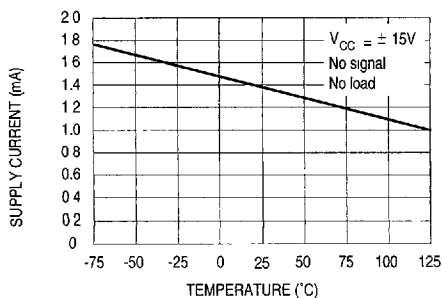

33001-15.EPS

**SUPPLY CURRENT PER AMPLIFIER
VERSUS SUPPLY VOLTAGE**

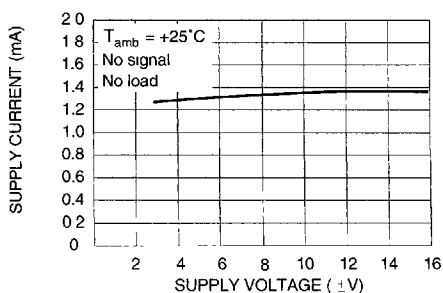

33001-16.EPS

**COMMON MODE REJECTION RATIO
VERSUS FREE AIR TEMPERATURE**

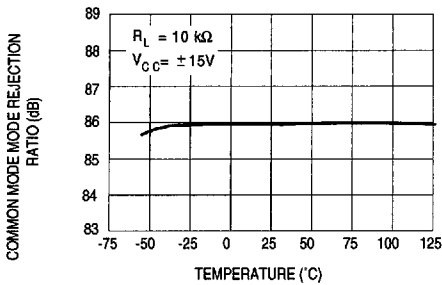

33001-17.EPS

**VOLTAGE FOLLOWER LARGE SIGNAL
PULSE RESPONSE**

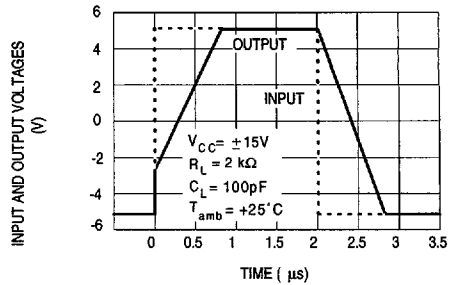

33001-18.EPS

**OUTPUT VOLTAGE VERSUS
ELAPSED TIME**

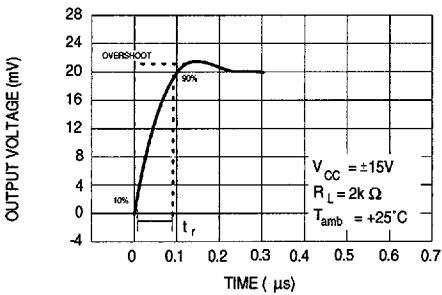

33001-19.EPS

**EQUIVALENT INPUT NOISE VOLTAGE
VERSUS FREQUENCY**

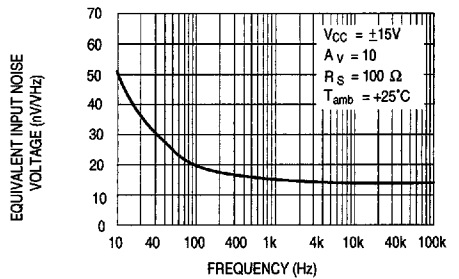

33001-20.EPS

**TOTAL HARMONIC DISTORTION VERSUS
FREQUENCY**

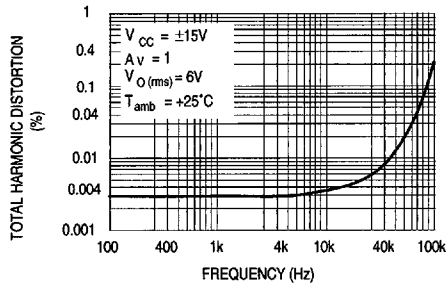

33001-21.EPS

PARAMETER MEASUREMENT INFORMATION

Figure 1 : Voltage Follower

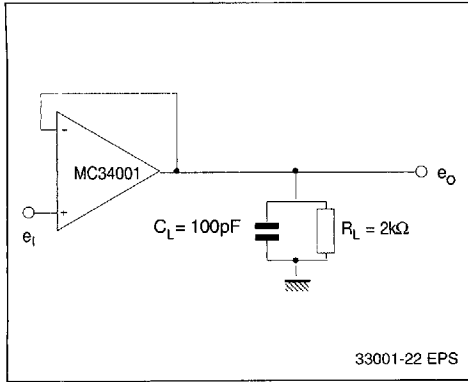
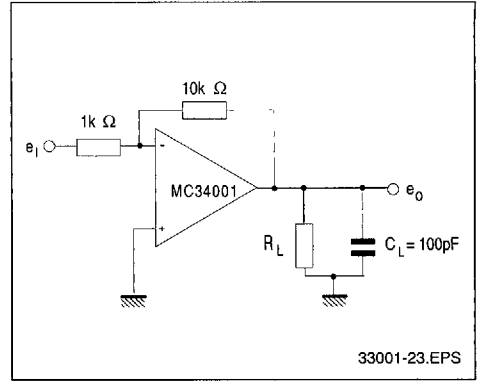
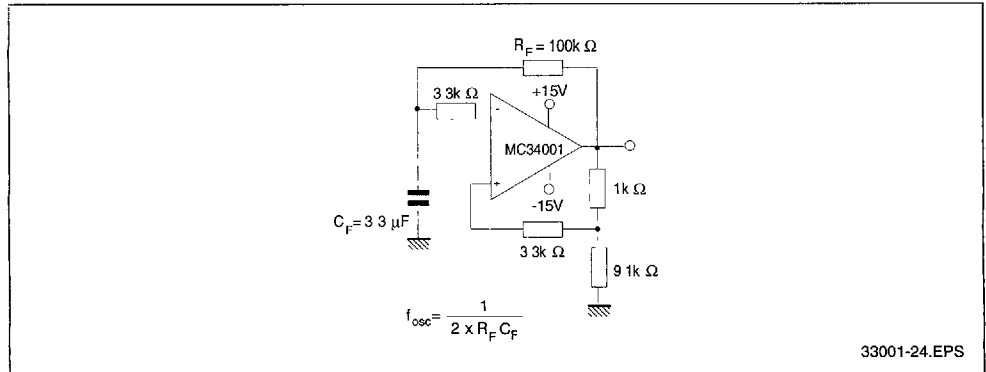

Figure 2 : Gain-of-10 Inverting Amplifier



TYPICAL APPLICATIONS

(0.5Hz) SQUARE WAVE OSCILLATOR



HIGH Q NOTCH FILTER

