

3 AMP POSITIVE ADJUSTABLE VOLTAGE REGULATOR

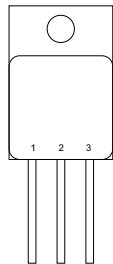

Pin 1 – ADJ.
 Pin 2 – V_{OUT}
 Case – V_{IN}

Q Package – TO254

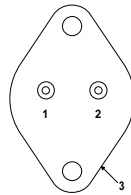

Pin 1 – ADJ.
 Pin 2 – V_{IN}
 Case – V_{OUT}

K Package – TO-3

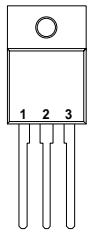

Pin 1 – ADJ.
 Pin 2 – V_{OUT}
 Pin 3 – V_{IN}
 Case – V_{OUT}

V Package – TO-218

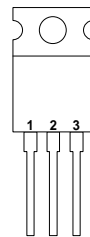

Pin 1 – ADJ.
 Pin 2 – V_{OUT}
 Pin 3 – V_{IN}
 Case – V_{OUT}

T Package – TO-220

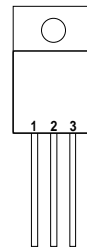

Pin 1 – ADJ.
 Pin 2 – V_{OUT}
 Pin 3 – V_{IN}
 Case – V_{OUT}^*

G Package – TO-257
IG Package - TO-257
 * Isolated case on IG Package

FEATURES

- OUTPUT VOLTAGE RANGE OF 1.25 TO 35V
- 1% OUTPUT VOLTAGE TOLERANCE (-A VERSIONS)
- 0.3% LOAD REGULATION
- 0.01%/V LINE REGULATION
- COMPLETE SERIES OF PROTECTIONS:
 - CURRENT LIMITING
 - THERMAL SHUTDOWN
 - SOA CONTROL

Order Information

Part Number	K-Pack (TO-3)	G/IG-Pack (TO-257)	T-Pack (TO-220)	V-Pack (TO-218)	Q-Pack (TO-254)	Temp. Range	Note:
IP150A	✓	✓			✓	-55 to +150°C	To order, add the package identifier to the part number. eg. IP150AQ
IP150	✓	✓			✓	"	
LM150	✓				✓	-55 to +150°C	
IP350A	✓		✓	✓		0 to 125°C	
IP350	✓		✓	✓		"	

ABSOLUTE MAXIMUM RATINGS ($T_{case} = 25^{\circ}C$ unless otherwise stated)

V_{I-O}	Input - Output Differential Voltage	35V
P_D	Power Dissipation	Internally limited
T_J	Operating Junction Temperature Range	See Table Above
T_{STG}	Storage Temperature	-65 to 150°C
T_L	Lead Temperature (Soldering, 10 sec.)	300°C

Parameter	Test Conditions	IP150A			LM150 IP150			Units
		Min.	Typ.	Max.	Min.	Typ.	Max.	
V_{REF} Reference Voltage	$I_{OUT} = 10\text{mA}$	1.238	1.25	1.262				V
	$I_{OUT} = 10\text{mA to } 3\text{A}$ $V_{IN} - V_{OUT} = 3\text{V to } 35\text{V}$ $P \leq 30\text{W}$ $T_J = -55 \text{ to } +150^\circ\text{C}$	1.225	1.250	1.270	1.200	1.250	1.300	V
$\frac{\Delta V_{OUT}}{\Delta I_{OUT}}$ Line Regulation 1	$V_{IN} - V_{OUT} = 3\text{V to } 35\text{V}$ $T_J = -55 \text{ to } +150^\circ\text{C}$		0.005	0.010		0.005	0.010	% / V
			0.020	0.050		0.020	0.050	
$\frac{\Delta V_{OUT}}{\Delta I_{OUT}}$ Load Regulation 1	$I_{OUT} = 10\text{mA to } 3\text{A}$ $V_{OUT} \leq 5\text{V}$ $T_J = -55 \text{ to } +150^\circ\text{C}$		5	15		5	15	mV
			15	50		20	50	
	$I_{OUT} = 10\text{mA to } 3\text{A}$ $V_{OUT} \geq 5\text{V}$ $T_J = -55 \text{ to } +150^\circ\text{C}$		0.1	0.3		0.1	0.3	%
			0.3	1		0.3	1	
Thermal Regulation	$t_p = 20\text{ms}$ $T_A = 25^\circ\text{C}$		0.002	0.010		0.002	0.010	%/W
Ripple Rejection	$V_{OUT} = 10\text{V}$ $f = 120\text{Hz}$ $T_J = -55 \text{ to } +150^\circ\text{C}$	$C_{ADJ} = 0$		65		65		dB
		$C_{ADJ} = 10\mu\text{F}$	66	86	66	86		dB
I_{ADJ} Adjust Pin Current	$T_J = -55 \text{ to } +150^\circ\text{C}$		50	100		50	100	μA
ΔI_{ADJ} Adjust Pin Current Change	$I_{OUT} = 10\text{mA to } 3\text{A}$ $V_{IN} - V_{OUT} = 3\text{V to } 35\text{V}$ $T_J = -55 \text{ to } +150^\circ\text{C}$		0.2	5		0.2	5	μA
I_{MIN} Minimum Load Current	$V_{IN} - V_{OUT} = 35\text{V}$ $T_J = -55 \text{ to } +150^\circ\text{C}$		3.5	5		3.5	5	mA
I_{CL} Current Limit	$V_{IN} - V_{OUT} \leq 10\text{V}$ $T_J = -55 \text{ to } +150^\circ\text{C}$	3	4.5		3	4.5		A
	$V_{IN} - V_{OUT} = 30\text{V}$	0.3	1		0.3	1		A
$\frac{\Delta V_{OUT}}{\Delta \text{TEMP}}$ Temperature Stability	$T_J = -55 \text{ to } +150^\circ\text{C}$		1	2		1		%
$\frac{\Delta V_{OUT}}{\Delta \text{TIME}}$ Long Term Stability	$T_A = 125^\circ\text{C}$ $t = 1000 \text{ Hrs}$		0.3	1		0.3	1	%
e_n RMS Output Noise (% of V_{OUT})	$f = 10 \text{ Hz to } 10 \text{ kHz}$ $T_A = 25^\circ\text{C}$		0.001			0.001		%
$R_{\theta JC}$ Thermal Resistance Junction to Case	K Package (TO-3)		1.5			1.5		$^\circ\text{C/W}$
	G Package (TO-257)		3	4		3	4	

- 1) Regulation is measured at constant junction temperature, using pulse testing at a low duty cycle. Changes in output voltage due to heating effects are covered under thermal regulation specifications. Load regulation is measured from the bottom of the package for the TO-3 package and on the back of the heat tab for the TO-218, TO-220 and TO-257 packages.
- 2) Test Conditions unless otherwise stated: $V_{IN} - V_{OUT} = 5\text{V}$, $T_J = 25^\circ\text{C}$, $I_{OUT} = 1.5\text{A}$.
Although power dissipation is internally limited, these specifications apply for dissipations of 30W for the TO-3, TO-218 and TO-257 packages, and 25W for the TO-220 package; $I_{MAX} = 3\text{A}$.

Parameter	Test Conditions	IP350A			IP350			Units
		Min.	Typ.	Max.	Min.	Typ.	Max.	
V_{REF} Reference Voltage	$I_{OUT} = 10mA$	1.238	1.25	1.262				V
	$I_{OUT} = 10mA$ to 3A $V_{IN} - V_{OUT} = 3V$ to 35V $P \leq 30W$ $T_J = 0$ to +125°C	1.225	1.250	1.270	1.200	1.250	1.300	V
$\frac{\Delta V_{OUT}}{\Delta I_{OUT}}$ Line Regulation 1	$V_{IN} - V_{OUT} = 3V$ to 35V $T_J = 0$ to +125°C		0.005	0.010		0.005	0.030	% / V
	$T_J = 0$ to +125°C		0.020	0.050		0.020	0.070	
$\frac{\Delta V_{OUT}}{\Delta I_{OUT}}$ Load Regulation 1	$I_{OUT} = 10mA$ to 3A $V_{OUT} \leq 5V$ $T_J = 0$ to +125°C		5	15		5	25	mV
	$T_J = 0$ to +125°C		15	50		20	70	
	$I_{OUT} = 10mA$ to 3A $V_{OUT} \geq 5V$ $T_J = 0$ to +125°C		0.1	0.3		0.1	0.5	%
	$T_J = 0$ to +125°C		0.3	1		0.3	1.5	
Thermal Regulation	$t_p = 20ms$ $T_A = 25^\circ C$		0.002	0.010		0.002	0.030	%/W
Ripple Rejection	$V_{OUT} = 10V$ $f = 120Hz$ $C_{ADJ} = 0$		65			65		dB
	$C_{ADJ} = 10\mu F$ $T_J = 0$ to +125°C	66	86		66	86		dB
I_{ADJ} Adjust Pin Current	$T_J = 0$ to +125°C		50	100		50	100	μA
ΔI_{ADJ} Adjust Pin Current Change	$I_{OUT} = 10mA$ to 3A $V_{IN} - V_{OUT} = 3V$ to 35V $T_J = 0$ to +125°C		0.2	5		0.2	5	μA
I_{MIN} Minimum Load Current	$V_{IN} - V_{OUT} = 35V$ $T_J = 0$ to +125°C		3.5	5		3.5	10	mA
I_{CL} Current Limit	$V_{IN} - V_{OUT} \leq 10V$ $T_J = 0$ to +125°C	3	4.5		3	4.5		A
	$V_{IN} - V_{OUT} = 30V$	0.25	1		0.25	1		A
$\frac{\Delta V_{OUT}}{\Delta TEMP}$ Temperature Stability	$T_J = 0$ to +125°C		1	2		1		%
$\frac{\Delta V_{OUT}}{\Delta TIME}$ Long Term Stability	$T_A = 125^\circ C$ $t = 1000$ Hrs		0.3	1		0.3	1	%
e_n RMS Output Noise (% of V_{OUT})	$f = 10$ Hz to 10 kHz $T_A = 25^\circ C$		0.001			0.001		%
$R_{\theta JC}$ Thermal Resistance Junction to Case	K Package (TO-3)		1.5			1.5		°C/W
	T Package (TO-220)		3	4		3	4	
	V Package (TO-218)		1.5			1.5		

- Regulation is measured at constant junction temperature, using pulse testing at a low duty cycle. Changes in output voltage due to heating effects are covered under thermal regulation specifications. Load regulation is measured from the bottom of the package for the TO-3 package and on the back of the heat tab for the TO-218, TO-220 and TO-257 packages.
- Test Conditions unless otherwise stated: $V_{IN} - V_{OUT} = 5V$, $T_J = 25^\circ C$, $I_{OUT} = 1.5A$. Although power dissipation is internally limited, these specifications apply for dissipations of 30W for the TO-3, TO-218 and TO-257 packages, and 25W for the TO-220 package; $I_{MAX} = 3A$.

TYPICAL PERFORMANCE CHARACTERISTICS

Load Regulation

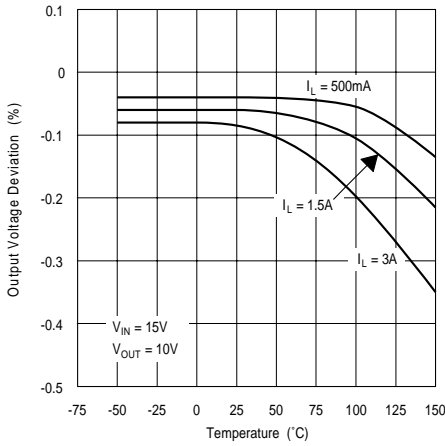

Output Impedance

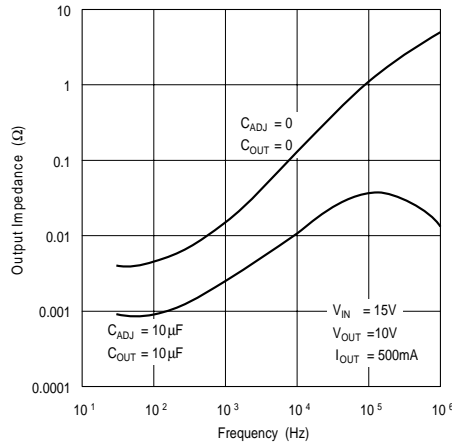

Adjustment Current

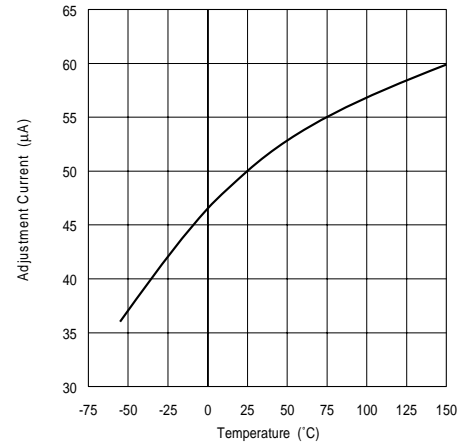

Dropout Voltage

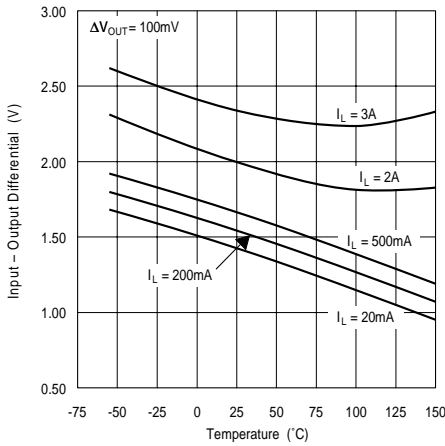

Temperature Stability

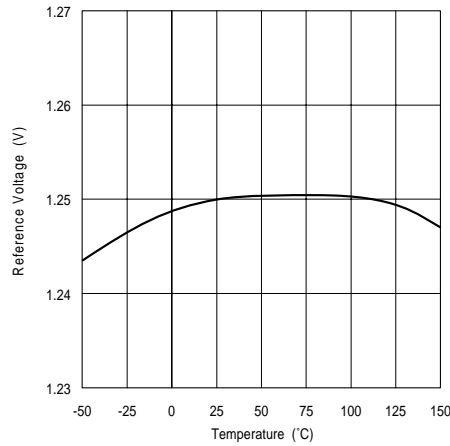

Minimum Operating Current

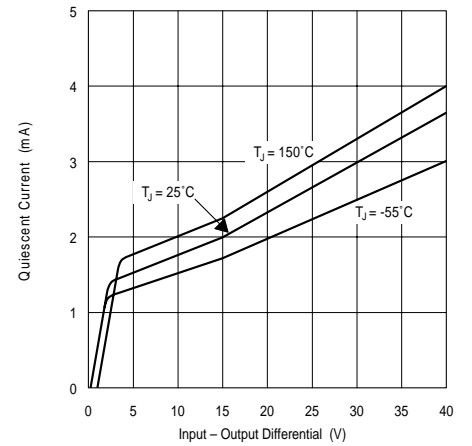

Ripple Rejection

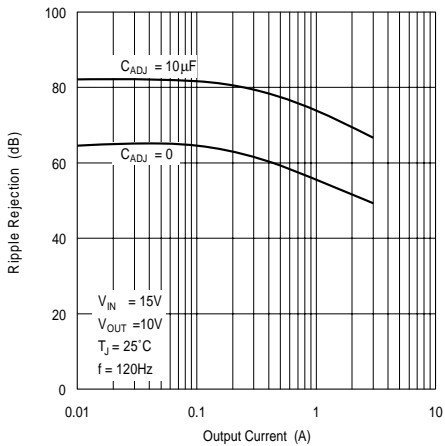

Ripple Rejection

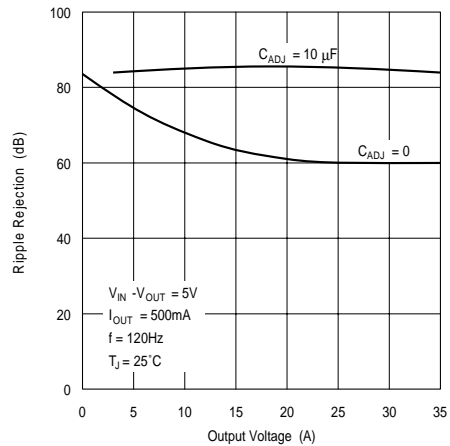

Ripple Rejection

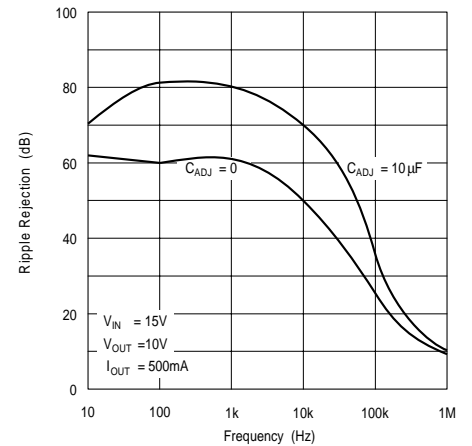

TYPICAL PERFORMANCE CHARACTERISTICS

Current Limit

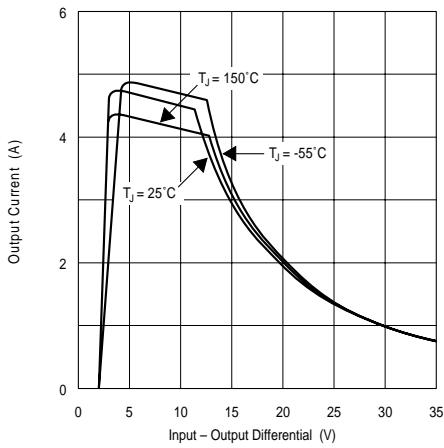

Current Limit

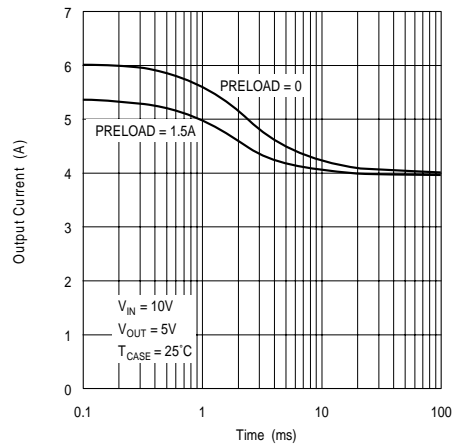

Current Limit

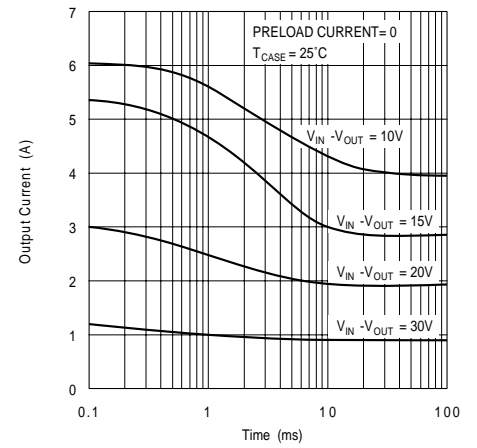

Line Transient Response

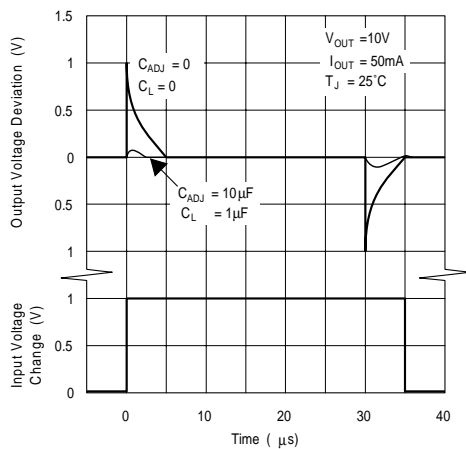

Load Transient Response

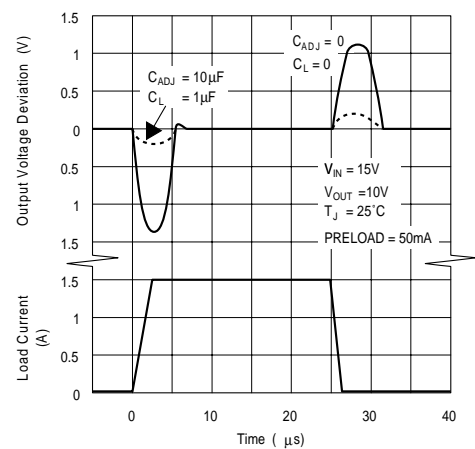

APPLICATIONS INFORMATION

Remote Sensing

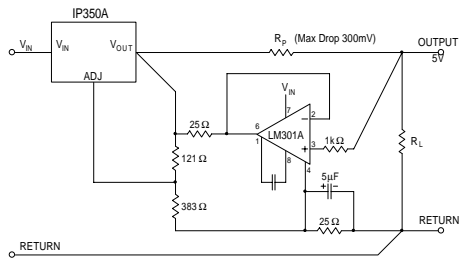

5V Regulator with Shut Down

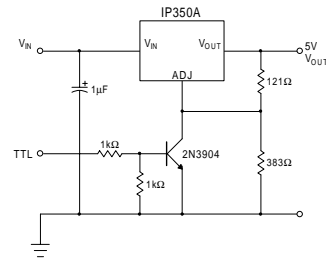

2816 EEPROM Supply Programmer for Read/Write Control

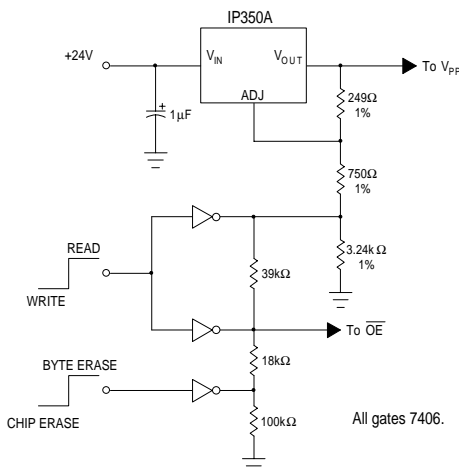

	\overline{OE}	V_{PP}
READ	0V	5V
WRITE		
BYTE ERASE	5V	21V
CHIP ERASE	12V	21V

Improving Ripple Rejection

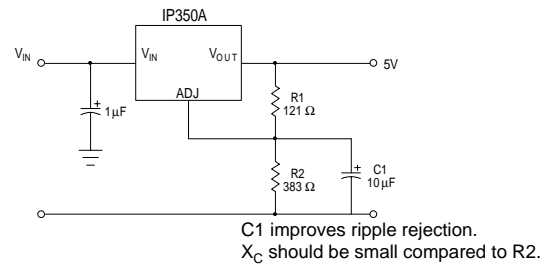

Temperature Compensated Lead-Acid Battery Charger

