

Programmable Unijunction Transistors

Silicon Programmable Unijunction Transistors

... designed to enable the engineer to "program" unijunction characteristics such as R_{BB} , η , I_V , and I_P by merely selecting two resistor values. Application includes thyristor-trigger, oscillator, pulse and timing circuits. These devices may also be used in special thyristor applications due to the availability of an anode gate. Supplied in an inexpensive TO-92 plastic package for high-volume requirements, this package is readily adaptable for use in automatic insertion equipment.

- Programmable — R_{BB} , η , I_V and I_P .
- Low On-State Voltage — 1.5 Volts Maximum @ $I_F = 50$ mA
- Low Gate to Anode Leakage Current — 10 nA Maximum
- High Peak Output Voltage — 11 Volts Typical
- Low Offset Voltage — 0.35 Volt Typical ($R_G = 10$ k ohms)

2N6027
2N6028

PUTs
40 VOLTS
300 mW

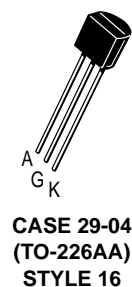
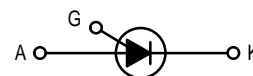

MAXIMUM RATINGS ($T_J = 25^\circ\text{C}$ unless otherwise noted.)

Rating	Symbol	Value	Unit
*Power Dissipation Derate Above 25°C	P_F $1/\theta_{JA}$	300 4	mW mW/ $^\circ\text{C}$
*DC Forward Anode Current Derate Above 25°C	I_T	150 2.67	mA mA/ $^\circ\text{C}$
*DC Gate Current	I_G	± 50	mA
Repetitive Peak Forward Current 100 μs Pulse Width, 1% Duty Cycle *20 μs Pulse Width, 1% Duty Cycle	I_{TRM}	1 2	Amps
Non-repetitive Peak Forward Current 10 μs Pulse Width	I_{TSM}	5	Amps
*Gate to Cathode Forward Voltage	V_{GKF}	40	Volts
*Gate to Cathode Reverse Voltage	V_{GKR}	-5	Volts
*Gate to Anode Reverse Voltage	V_{GAR}	40	Volts
*Anode to Cathode Voltage ⁽¹⁾	V_{AK}	± 40	Volts
Operating Junction Temperature Range	T_J	-50 to +100	$^\circ\text{C}$
*Storage Temperature Range	T_{stg}	-55 to +150	$^\circ\text{C}$

*Indicates JEDEC Registered Data

1. Anode positive, $R_{GA} = 1000$ ohms
Anode negative, $R_{GA} = \text{open}$

2N6027 2N6028

ELECTRICAL CHARACTERISTICS (T_C = 25°C unless otherwise noted.)

Characteristic	Fig. No.	Symbol	Min	Typ	Max	Unit
*Peak Current (V _S = 10 Vdc, R _G = 1 MΩ) (V _S = 10 Vdc, R _G = 10 k ohms)	2,9,11	I _P	— — — —	1.25 0.08 4 0.70	2 0.15 5 1	μA
*Offset Voltage (V _S = 10 Vdc, R _G = 1 MΩ) (V _S = 10 Vdc, R _G = 10 k ohms)	1	V _T	0.2 0.2 0.2	0.70 0.50 0.35	1.6 0.6 0.6	Volts
*Valley Current (V _S = 10 Vdc, R _G = 1 MΩ) (V _S = 10 Vdc, R _G = 10 k ohms) (V _S = 10 Vdc, R _G = 200 ohms)	1,4,5	I _V	— — 70 25 1.5 1	18 18 150 150 — —	50 25 — — — —	μA mA
*Gate to Anode Leakage Current (V _S = 40 Vdc, T _A = 25°C, Cathode Open) (V _S = 40 Vdc, T _A = 75°C, Cathode Open)	—	I _{GAO}	— —	1 3	10 —	nAdc
Gate to Cathode Leakage Current (V _S = 40 Vdc, Anode to Cathode Shorted)	—	I _{GKS}	—	5	50	nAdc
*Forward Voltage (I _F = 50 mA Peak)	1,6	V _F	—	0.8	1.5	Volts
*Peak Output Voltage (V _G = 20 Vdc, C _C = 0.2 μF)	3,7	V _O	6	11	—	Volt
Pulse Voltage Rise Time (V _B = 20 Vdc, C _C = 0.2 μF)	3	t _r	—	40	80	ns

*Indicates JEDEC Registered Data.

FIGURE 1 – ELECTRICAL CHARACTERIZATION

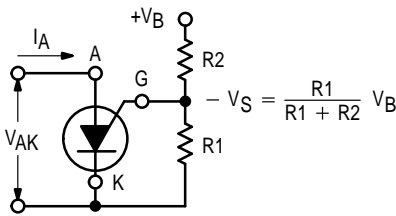

1A – Programmable Unijunction with "Program" Resistors R1 and R2

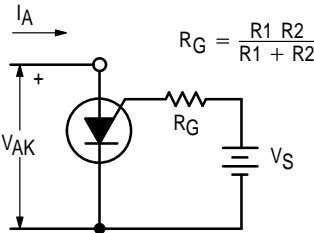

1B – Equivalent Test Circuit for Figure 1A used for electrical characteristics testing (also see Figure 2)

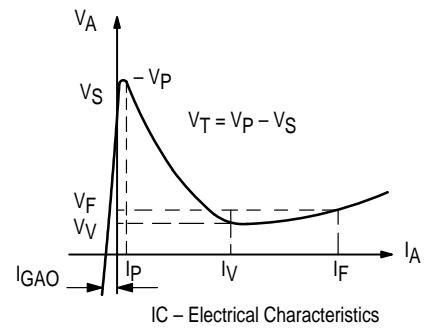

FIGURE 2 – PEAK CURRENT (I_P) TEST CIRCUIT

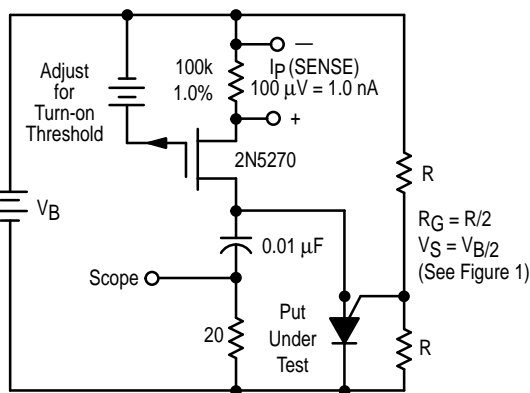
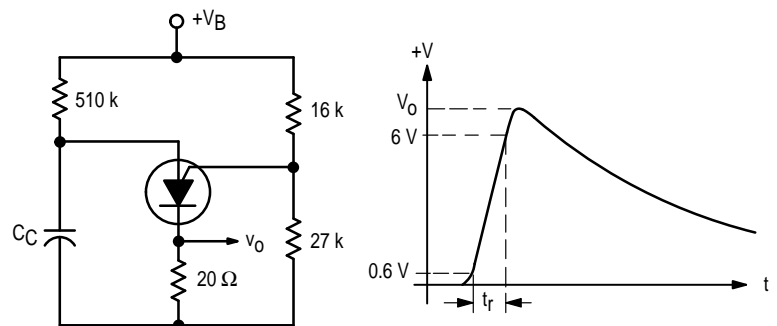

FIGURE 3 – V_O AND t_r TEST CIRCUIT



TYPICAL VALLEY CURRENT BEHAVIOR

FIGURE 4 – EFFECT OF SUPPLY VOLTAGE

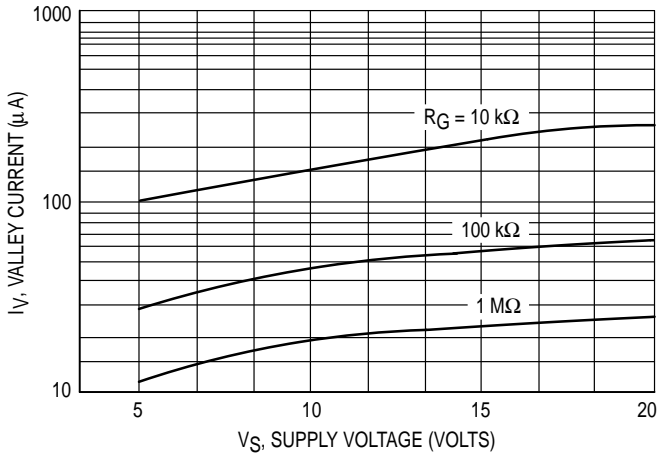

FIGURE 5 – EFFECT OF TEMPERATURE

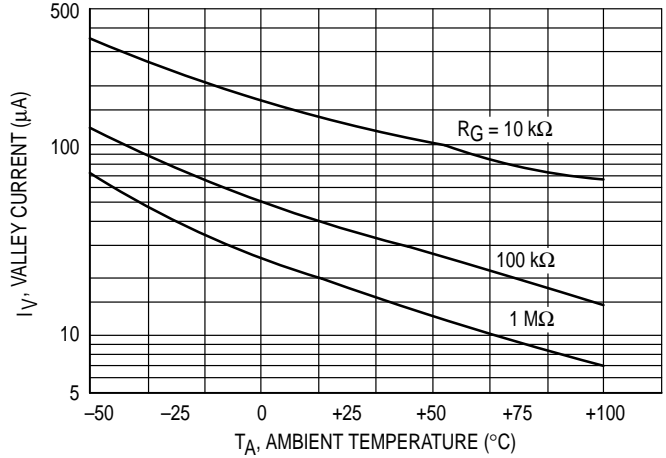

FIGURE 6 – FORWARD VOLTAGE

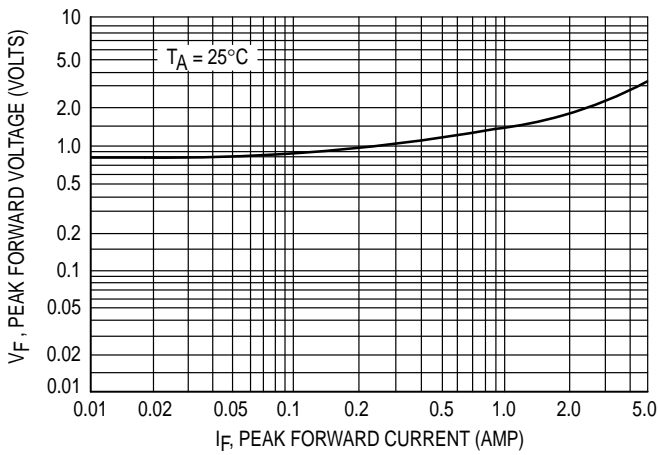

FIGURE 7 – PEAK OUTPUT VOLTAGE

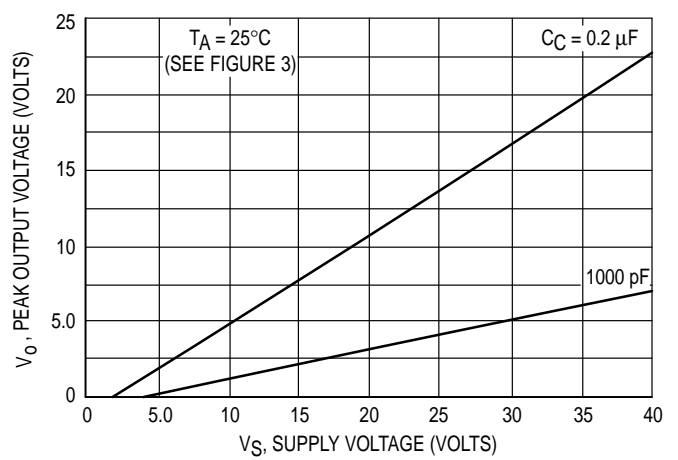
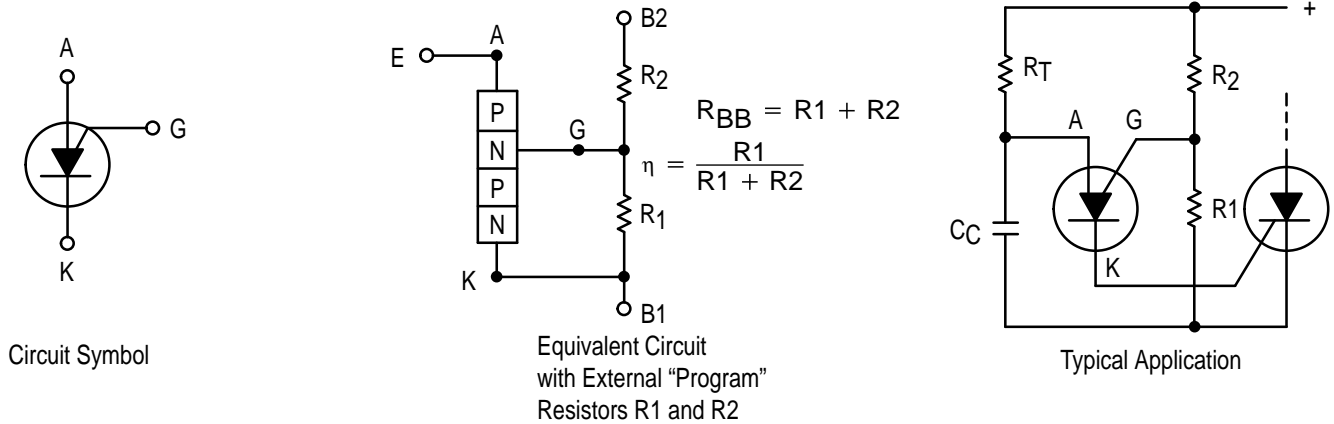

FIGURE 8 PROGRAMMABLE UNIJUNCTION



TYPICAL PEAK CURRENT BEHAVIOR

2N6027

FIGURE 9 – EFFECT OF SUPPLY VOLTAGE AND R_G

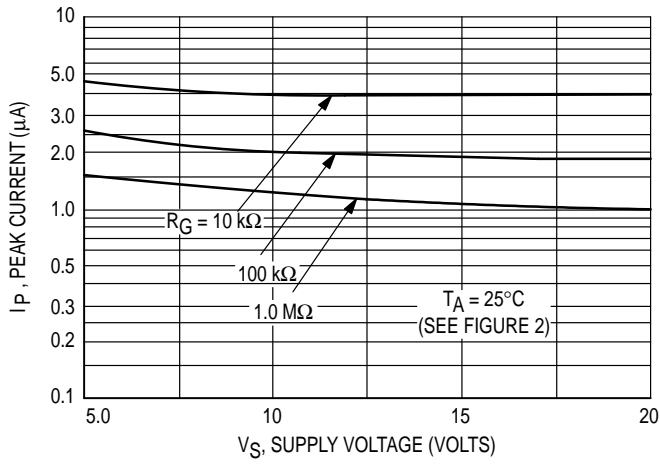
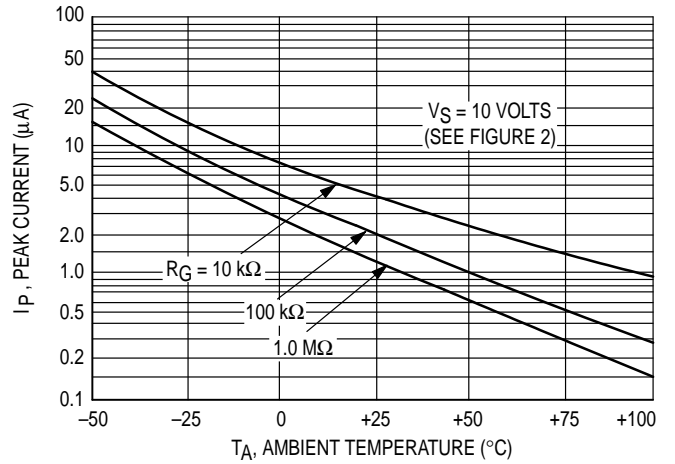

FIGURE 10 – EFFECT OF TEMPERATURE AND R_G



2N6028

FIGURE 11 – EFFECT OF SUPPLY VOLTAGE AND R_G

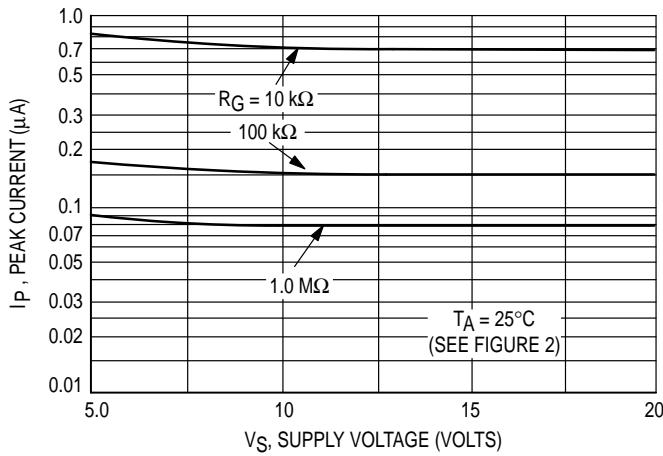
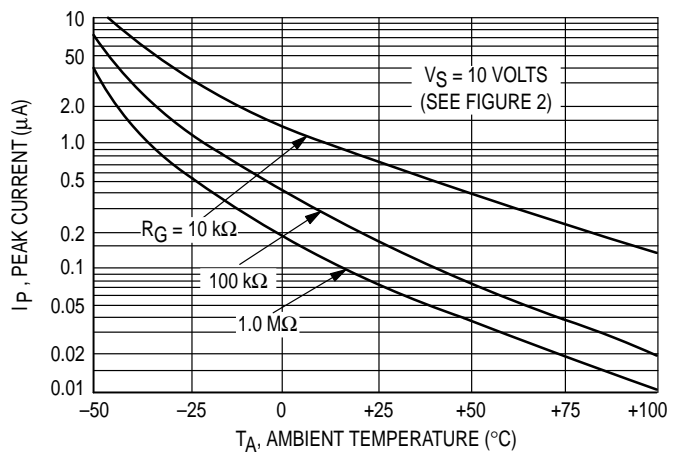
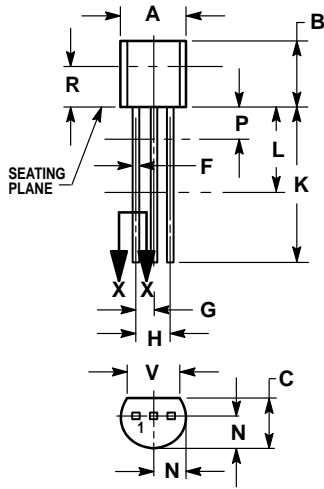

FIGURE 12 – EFFECT OF TEMPERATURE AND R_G



PACKAGE DIMENSIONS



STYLE 16:
 PIN 1. ANODE
 2. GATE
 3. CATHODE
 3. SOURCE

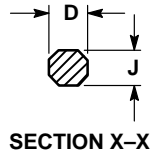

NOTES:

1. DIMENSIONING AND TOLERANCING PER ANSI Y14.5M, 1982.
2. CONTROLLING DIMENSION: INCH.
3. CONTOUR OF PACKAGE BEYOND DIMENSION R IS UNCONTROLLED.
4. DIMENSION F APPLIES BETWEEN P AND L. DIMENSION D AND J APPLY BETWEEN L AND K MINIMUM. LEAD DIMENSION IS UNCONTROLLED IN P AND BEYOND DIMENSION K MINIMUM.

DIM	INCHES		MILLIMETERS	
	MIN	MAX	MIN	MAX
A	0.175	0.205	4.45	5.20
B	0.170	0.210	4.32	5.33
C	0.125	0.165	3.18	4.19
D	0.016	0.022	0.41	0.55
F	0.016	0.019	0.41	0.48
G	0.045	0.055	1.15	1.39
H	0.095	0.105	2.42	2.66
J	0.015	0.020	0.39	0.50
K	0.500	—	12.70	—
L	0.250	—	6.35	—
N	0.080	0.105	2.04	2.66
P	—	0.100	—	2.54
R	0.115	—	2.93	—
V	0.135	—	3.43	—

CASE 029-04
 (TO-226AA)

Motorola reserves the right to make changes without further notice to any products herein. Motorola makes no warranty, representation or guarantee regarding the suitability of its products for any particular purpose, nor does Motorola assume any liability arising out of the application or use of any product or circuit, and specifically disclaims any and all liability, including without limitation consequential or incidental damages. "Typical" parameters can and do vary in different applications. All operating parameters, including "Typicals" must be validated for each customer application by customer's technical experts. Motorola does not convey any license under its patent rights nor the rights of others. Motorola products are not designed, intended, or authorized for use as components in systems intended for surgical implant into the body, or other applications intended to support or sustain life, or for any other application in which the failure of the Motorola product could create a situation where personal injury or death may occur. Should Buyer purchase or use Motorola products for any such unintended or unauthorized application, Buyer shall indemnify and hold Motorola and its officers, employees, subsidiaries, affiliates, and distributors harmless against all claims, costs, damages, and expenses, and reasonable attorney fees arising out of, directly or indirectly, any claim of personal injury or death associated with such unintended or unauthorized use, even if such claim alleges that Motorola was negligent regarding the design or manufacture of the part. Motorola and [®] are registered trademarks of Motorola, Inc. Motorola, Inc. is an Equal Opportunity/Affirmative Action Employer.

Literature Distribution Centers:

USA: Motorola Literature Distribution; P.O. Box 20912; Phoenix, Arizona 85036.

EUROPE: Motorola Ltd.; European Literature Centre; 88 Tanners Drive, Blakelands, Milton Keynes, MK14 5BP, England.

JAPAN: Nippon Motorola Ltd.; 4-32-1, Nishi-Gotanda, Shinagawa-ku, Tokyo 141, Japan.

ASIA PACIFIC: Motorola Semiconductors H.K. Ltd.; Silicon Harbour Center, No. 2 Dai King Street, Tai Po Industrial Estate, Tai Po, N.T., Hong Kong.

