

## FEATURES

- **3-Lead SOT-23 Package**
- **Low Drift: 20ppm/°C Max**
- **High Accuracy: 0.2% Max**
- Low Supply Current
- 20mA Output Current Guaranteed
- No Output Capacitor Required
- Reverse-Battery Protection
- Low PC Board Solder Stress: 0.02% Typ
- Voltage Options: 2.5V, 3V, 3.3V, 5V and 10V
- The LT1460 is Also Available in SO-8, 8-Lead MSOP, 8-Lead PDIP and TO-92 Packages.
- Operating Temperature Range: -40°C to 85°C

## APPLICATIONS

- Handheld Instruments
- Precision Regulators
- A/D and D/A Converters
- Power Supplies
- Hard Disk Drives

## DESCRIPTION

The LT<sup>®</sup>1460S3 is a family of SOT-23 micropower series references that combine high accuracy and low drift with low power dissipation and small package size. These series references use curvature compensation to obtain low temperature coefficient, and laser trimmed precision thin-film resistors to achieve high output accuracy. Furthermore, output shift due to PC board soldering stress has been dramatically reduced. These references will supply up to 20mA, making them ideal for precision regulator applications, yet they are almost totally immune to input voltage variations.

These series references provide supply current and power dissipation advantages over shunt references that must idle the entire load current to operate. Additionally, the LT1460S3 does not require an output compensation capacitor. This feature is important in applications where PC board space is a premium or fast settling is demanded. Reverse-battery protection keeps these references from conducting reverse current.

LT, LTC and LT are registered trademarks of Linear Technology Corporation.

## TYPICAL APPLICATION

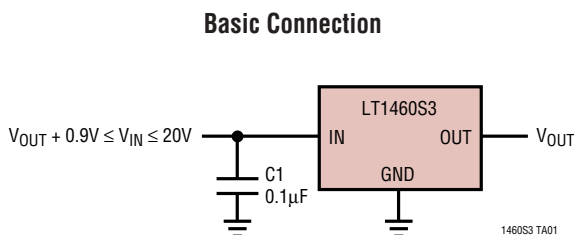

Typical Distribution of SOT-23 LT1460HC  
 $V_{OUT}$  After IR Reflow Solder

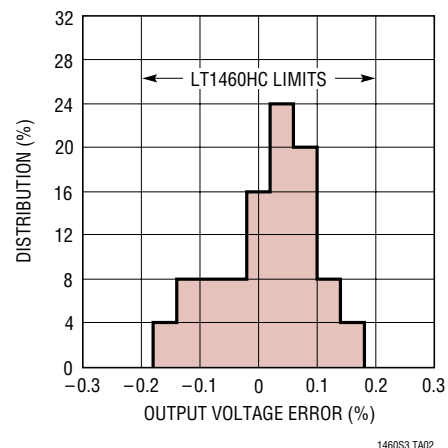

# LT1460S3 (SOT-23)

## ABSOLUTE MAXIMUM RATINGS (Note 1)

Input Voltage .....	30V	Operating Temperature Range	
Reverse Voltage .....	-15V	(Note 2) .....	-40°C to 85°C
Output Short-Circuit Duration, T <sub>A</sub> = 25°C .....	5 sec	Storage Temperature Range (Note 3) ...	-65°C to 150°C
Specified Temperature Range .....	0°C to 70°C	Lead Temperature (Soldering, 10 sec) .....	300°C

## PACKAGE/ORDER INFORMATION

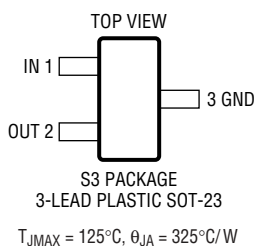

	ORDER PART NUMBER	S3 PART MARKING†
	LT1460HCS3-2.5	LTAC
	LT1460JCS3-2.5	LTAD
	LT1460KCS3-2.5	LTAE
	LT1460HCS3-3	LTAN
	LT1460JCS3-3	LTAP
	LT1460KCS3-3	LTAQ
	LT1460HCS3-3.3	LTAR
	LT1460JCS3-3.3	LTAS
	LT1460KCS3-3.3	LTAT
	LT1460HCS3-5	LTAK
	LT1460JCS3-5	LTAL
	LT1460KCS3-5	LTAM
	LT1460HCS3-10	LTAU
	LT1460JCS3-10	LTAV
	LT1460KCS3-10	LTAW

†Product may be identified with either part marking. \*The temperature grades and parametric grades are identified by a label on the shipping container. Consult factory for Industrial and Military grade parts.

## AVAILABLE OPTIONS

OUTPUT VOLTAGE (V)	SPECIFIED TEMPERATURE RANGE	ACCURACY (%)	TEMPERATURE COEFFICIENT (ppm/°C)	PART ORDER NUMBER
2.5	0°C to 70°C	0.2	20	LT1460HCS3-2.5
2.5	0°C to 70°C	0.4	20	LT1460JCS3-2.5
2.5	0°C to 70°C	0.5	50	LT1460KCS3-2.5
3	0°C to 70°C	0.2	20	LT1460HCS3-3
3	0°C to 70°C	0.4	20	LT1460JCS3-3
3	0°C to 70°C	0.5	50	LT1460KCS3-3
3.3	0°C to 70°C	0.2	20	LT1460HCS3-3.3
3.3	0°C to 70°C	0.4	20	LT1460JCS3-3.3
3.3	0°C to 70°C	0.5	50	LT1460KCS3-3.3
5	0°C to 70°C	0.2	20	LT1460HCS3-5
5	0°C to 70°C	0.4	20	LT1460JCS3-5
5	0°C to 70°C	0.5	50	LT1460KCS3-5
10	0°C to 70°C	0.2	20	LT1460HCS3-10
10	0°C to 70°C	0.4	20	LT1460JCS3-10
10	0°C to 70°C	0.5	50	LT1460KCS3-10

**ELECTRICAL CHARACTERISTICS** The ● denotes specifications which apply over the full specified temperature range, otherwise specifications are at  $T_A = 25^\circ\text{C}$ .  $V_{IN} = V_{OUT} + 2.5\text{V}$ ,  $I_{OUT} = 0$  unless otherwise specified.

PARAMETER	CONDITIONS	MIN	TYP	MAX	UNITS
Output Voltage Tolerance (Note 4)	LT1460HCS3	-0.2		0.2	%
	LT1460JCS3	-0.4		0.4	%
	LT1460KCS3	-0.5		0.5	%
Output Voltage Temperature Coefficient (Note 5)	LT1460HCS3	●	10	20	ppm/°C
	LT1460JCS3	●	10	20	ppm/°C
	LT1460KCS3	●	25	50	ppm/°C
Line Regulation	$V_{OUT} + 0.9\text{V} \leq V_{IN} \leq V_{OUT} + 2.5\text{V}$	●	150	800 1000	ppm/V ppm/V
	$V_{OUT} + 2.5\text{V} \leq V_{IN} \leq 20\text{V}$	●	50	100 130	ppm/V ppm/V
Load Regulation Sourcing (Note 6)	$I_{OUT} = 100\mu\text{A}$	●	1000	3000 4000	ppm/mA ppm/mA
	$I_{OUT} = 10\text{mA}$	●	50	200 300	ppm/mA ppm/mA
	$I_{OUT} = 20\text{mA}$	●	20	70 100	ppm/mA ppm/mA
Thermal Regulation (Note 7)	$\Delta P = 200\text{mW}$		2.5	10	ppm/mW
Dropout Voltage (Note 8)	$V_{IN} - V_{OUT}$ , $\Delta V_{OUT} \leq 0.2\%$ , $I_{OUT} = 0$	●		0.9	V
	$V_{IN} - V_{OUT}$ , $\Delta V_{OUT} \leq 0.2\%$ , $I_{OUT} = 10\text{mA}$	●		1.3 1.4	V V
Output Current	Short $V_{OUT}$ to GND		40		mA
Reverse Leakage	$V_{IN} = -15\text{V}$	●	0.5	10	$\mu\text{A}$
Output Voltage Noise (Note 9)	$0.1\text{Hz} \leq f \leq 10\text{Hz}$		4		ppm (P-P)
	$10\text{Hz} \leq f \leq 1\text{kHz}$		4		ppm (RMS)
Long-Term Stability of Output Voltage (Note 10)			100		ppm/ $\sqrt{\text{kHr}}$
Hysteresis (Note 11)	$\Delta T = 0^\circ\text{C}$ to $70^\circ\text{C}$	●	50		ppm
	$\Delta T = -40^\circ\text{C}$ to $85^\circ\text{C}$	●	250		ppm
Supply Current	LT1460S3-2.5	●	115	145 175	$\mu\text{A}$ $\mu\text{A}$
	LT1460S3-3	●	145	180 220	$\mu\text{A}$ $\mu\text{A}$
	LT1460S3-3.3	●	145	180 220	$\mu\text{A}$ $\mu\text{A}$
	LT1460S3-5	●	160	200 240	$\mu\text{A}$ $\mu\text{A}$
	LT1460S3-10	●	215	270 350	$\mu\text{A}$ $\mu\text{A}$

**Note 1:** Absolute Maximum Ratings are those values beyond which the life of a device may be impaired.

**Note 2:** The LT1460S3 is guaranteed functional over the operating temperature range of  $-40^\circ\text{C}$  to  $85^\circ\text{C}$ .

**Note 3:** If the parts are stored outside of the specified temperature range, the output may shift due to hysteresis.

**Note 4:** ESD (Electrostatic Discharge) sensitive devices. Extensive use of ESD protection devices are used internal to the LT1460S3, however, high electrostatic discharge can damage or degrade the device. Use proper ESD handling precautions.

**Note 5:** Temperature coefficient is measured by dividing the change in output voltage by the specified temperature range. Incremental slope is also measured at  $25^\circ\text{C}$ .

## ELECTRICAL CHARACTERISTICS

**Note 6:** Load regulation is measured on a pulse basis from no load to the specified load current. Output changes due to die temperature change must be taken into account separately.

**Note 7:** Thermal regulation is caused by die temperature gradients created by load current or input voltage changes. This effect must be added to normal line or load regulation. This parameter is not 100% tested.

**Note 8:** Excludes load regulation errors.

**Note 9:** Peak-to-peak noise is measured with a single pole highpass filter at 0.1Hz and 2-pole lowpass filter at 10Hz. The unit is enclosed in a still-air environment to eliminate thermocouple effects on the leads. The test time is 10 sec. RMS noise is measured with a single pole highpass filter at 10Hz and a 2-pole lowpass filter at 1kHz. The resulting output is full wave rectified and then integrated for a fixed period, making the final reading an average as opposed to RMS. A correction factor of 1.1 is used to convert from average to RMS and a second correction of 0.88 is used to correct for the nonideal bandpass of the filters.

**Note 10:** Long-term stability typically has a logarithmic characteristic and therefore, changes after 1000 hours tend to be much smaller than before that time. Total drift in the second thousand hours is normally less than one third that of the first thousand hours with a continuing trend toward reduced drift with time. Long-term stability will also be affected by differential stresses between the IC and the board material created during board assembly.

**Note 11:** Hysteresis in output voltage is created by package stress that differs depending on whether the IC was previously at a higher or lower temperature. Output voltage is always measured at 25°C, but the IC is cycled to 70°C or 0°C before successive measurements. Hysteresis is roughly proportional to the square of the temperature change. Hysteresis is not normally a problem for operational temperature excursions where the instrument might be stored at high or low temperature. See Applications Information.

## TYPICAL PERFORMANCE CHARACTERISTICS

Characteristic curves are similar for most LT1460S3s. Curves from the LT1460S3-2.5 and the LT1460-10 represent the extremes of the voltage options. Characteristic curves for other output voltages fall between these curves, and can be estimated based on their voltage output.

**2.5V Minimum Input-Output Voltage Differential**

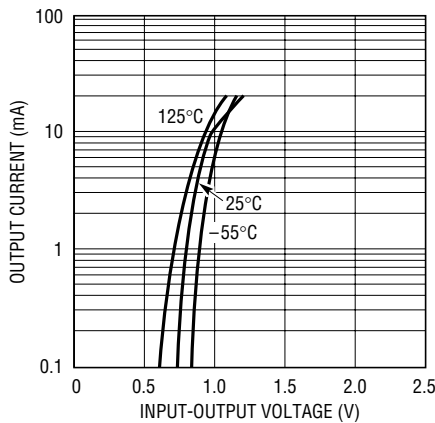

**2.5V Load Regulation, Sourcing**

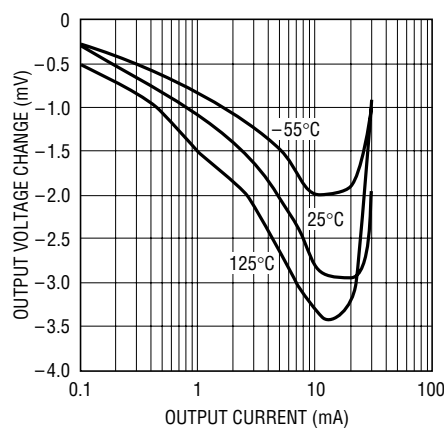

**2.5V Load Regulation, Sinking**

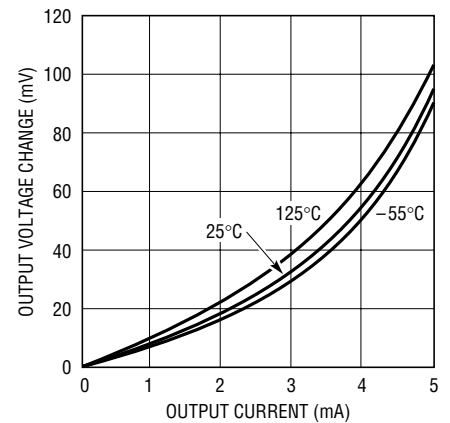

**TYPICAL PERFORMANCE CHARACTERISTICS** Characteristic curves are similar for most LT1460S3s. Curves from the LT1460S3-2.5 and the LT1460-10 represent the extremes of the voltage options. Characteristic curves for other output voltages fall between these curves, and can be estimated based on their voltage output.

**2.5V Output Voltage Temperature Drift**

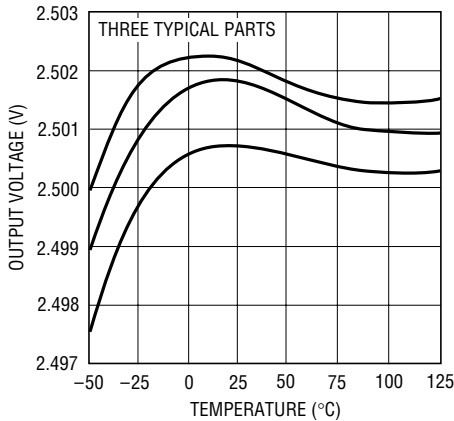

1460S3 G04

**2.5V Supply Current vs Input Voltage**

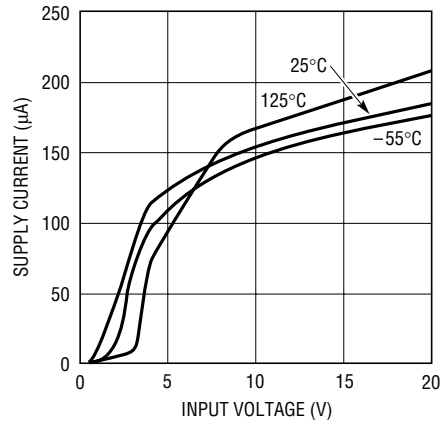

1460S3 G05

**2.5V Line Regulation**

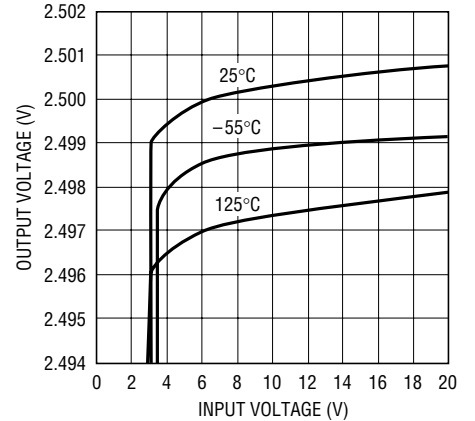

1460S3 G06

**2.5V Power Supply Rejection Ratio vs Frequency**

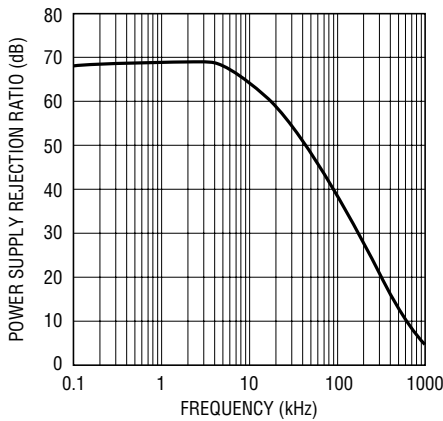

1460S3 G07

**2.5V Output Impedance vs Frequency**

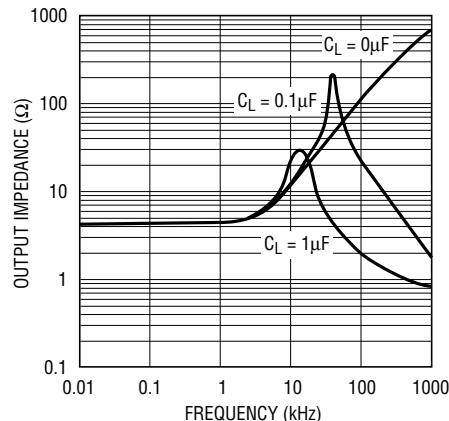

1460S3 G08

**2.5V Transient Response**

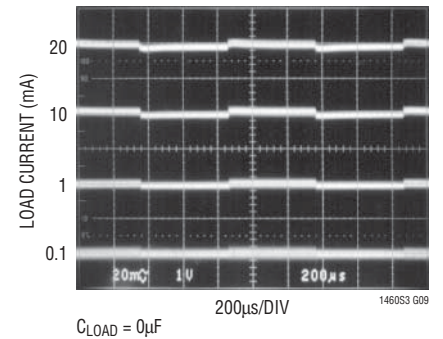

1460S3 G09

**2.5V Output Voltage Noise Spectrum**

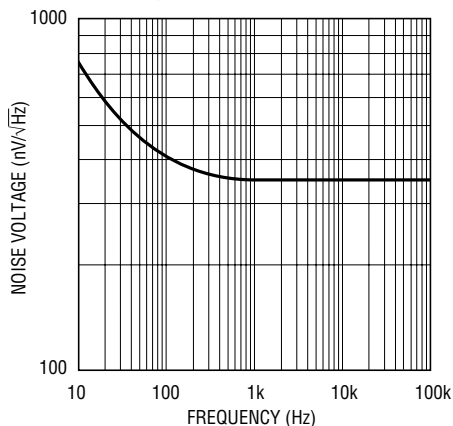

1460-2.5 G10

**2.5V Output Noise 0.1Hz to 10Hz**

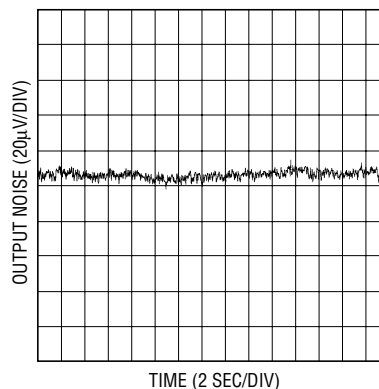

1460S3 G11

# LT1460S3 (SOT-23)

**TYPICAL PERFORMANCE CHARACTERISTICS** Characteristic curves are similar for most LT1460S3s. Curves from the LT1460S3-2.5 and the LT1460-10 represent the extremes of the voltage options. Characteristic curves for other output voltages fall between these curves, and can be estimated based on their voltage output.

**10V Minimum Input-Output Voltage Differential**

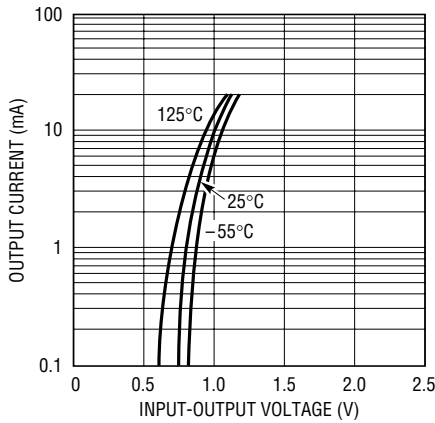

1460S3 G12

**10V Load Regulation, Sourcing**

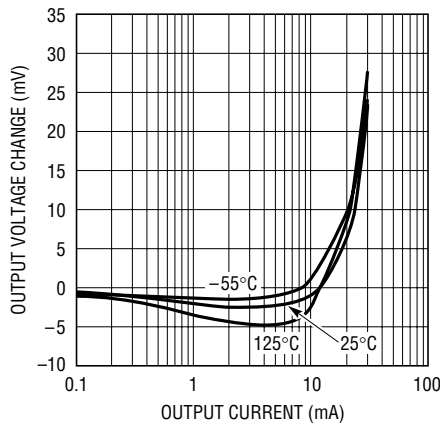

1460S3 G13

**10V Load Regulation, Sinking**

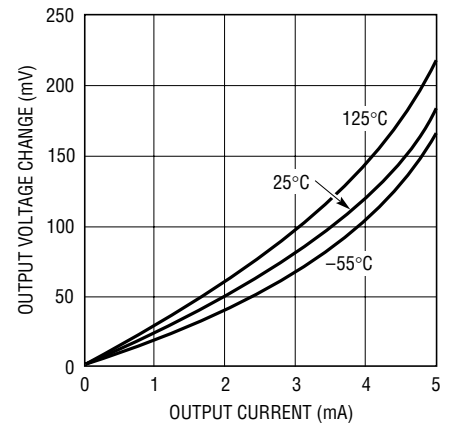

1460S3 G14

**10V Output Voltage Temperature Drift**

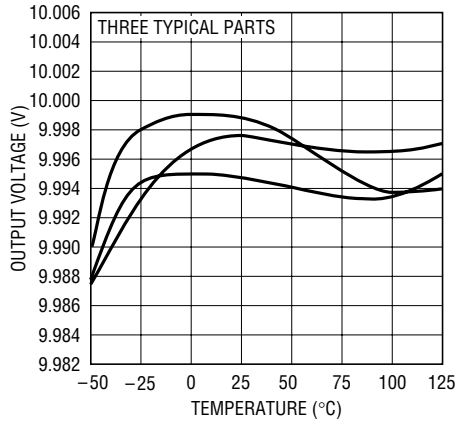

1460S3 G15

**10V Supply Current vs Input Voltage**

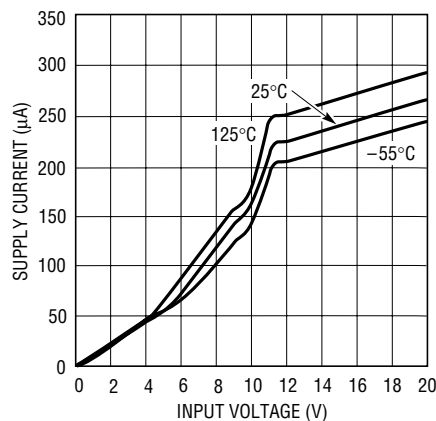

1460S3 G16

**10V Line Regulation**

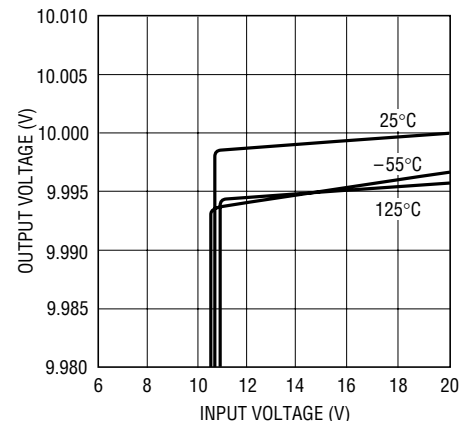

1560S3 G17

**10V Power Supply Rejection Ratio vs Frequency**

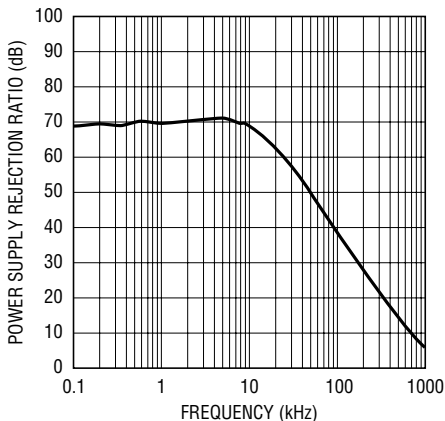

1460S3 G18

**10V Output Impedance vs Frequency**

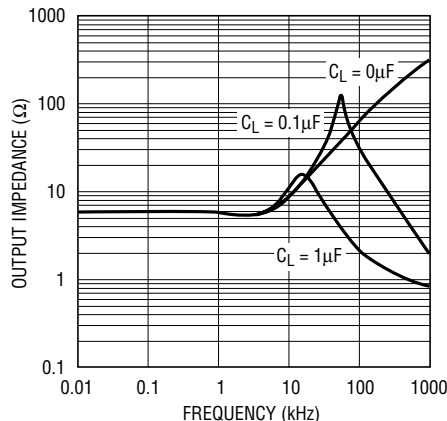

1460S3 G19

**10V Transient Response**

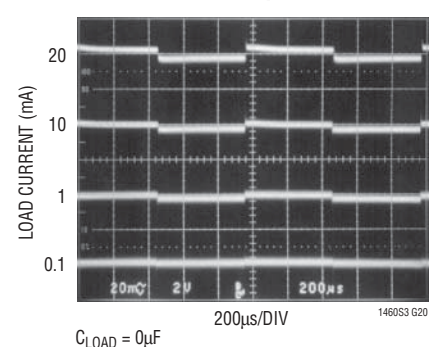

1460S3 G20

**TYPICAL PERFORMANCE CHARACTERISTICS** Characteristic curves are similar for most LT1460S3s. Curves from the LT1460S3-2.5 and the LT1460-10 represent the extremes of the voltage options. Characteristic curves for other output voltages fall between these curves, and can be estimated based on their voltage output.

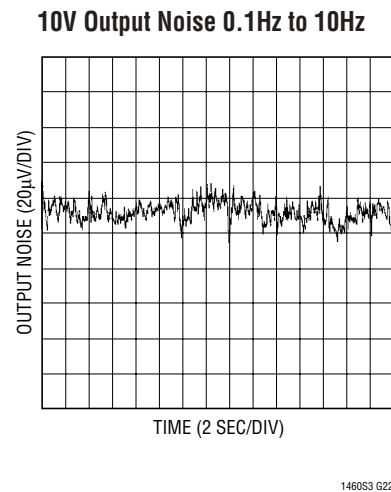
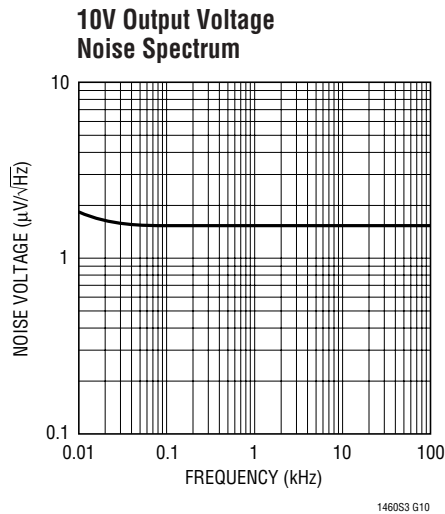

## APPLICATIONS INFORMATION

### Longer Battery Life

Series references have a large advantage over older shunt style references. Shunt references require a resistor from the power supply to operate. This resistor must be chosen to supply the maximum current that can ever be demanded by the circuit being regulated. When the circuit being controlled is not operating at this maximum current, the shunt reference must always sink this current, resulting in high dissipation and short battery life.

The LT1460S3 series references do not require a current setting resistor and can operate with any supply voltage from  $V_{\text{OUT}} + 0.9\text{V}$  to 20V. When the circuitry being regulated does not demand current, the LT1460S3s reduce their dissipation and battery life is extended. If the references are not delivering load current, they dissipate only several mW, yet the same connection can deliver 20mA of load current when demanded.

### Capacitive Loads

The LT1460S3 family of references are designed to be stable with a large range of capacitive loads. With no

capacitive load, these references are ideal for fast settling or applications where PC board space is a premium. The test circuit shown in Figure 1 is used to measure the response time and stability of various load currents and load capacitors. This circuit is set for the 2.5V option. For other voltage options, the input voltage must be scaled up and the output voltage generator offset voltage must be adjusted. The 1V step from 2.5V to 1.5V produces a current step of 10mA or 1mA for  $R_L = 100\Omega$  or  $R_L = 1\text{k}$ . Figure 2 shows the response of the reference to these 1mA and 10mA load steps with no load capacitance, and Figure 3 shows a 1mA and 10mA load step with a 0.1 $\mu\text{F}$  output capacitor. Figure 4 shows the response to a 1mA load step with  $C_L = 1\mu\text{F}$  and 4.7 $\mu\text{F}$ .

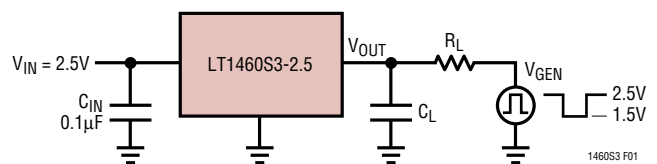
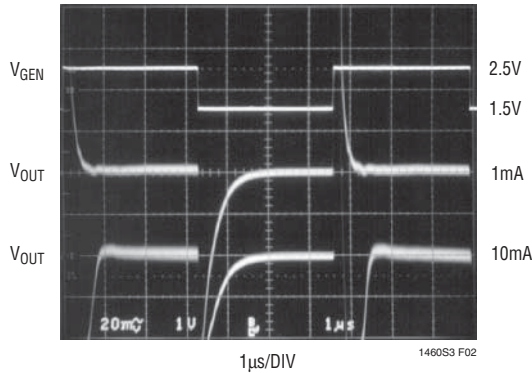
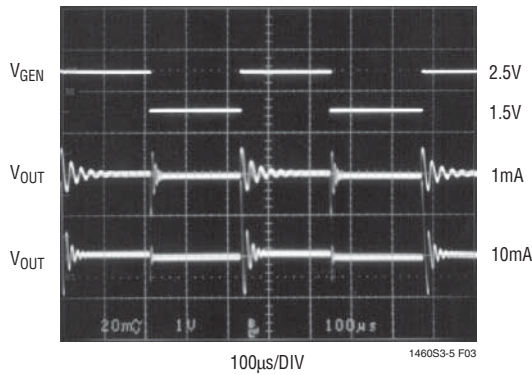

Figure 1. Response Time Test Circuit

**APPLICATIONS INFORMATION**



**Figure 2.  $C_L = 0\mu F$**



**Figure 3.  $C_L = 0.1\mu F$**

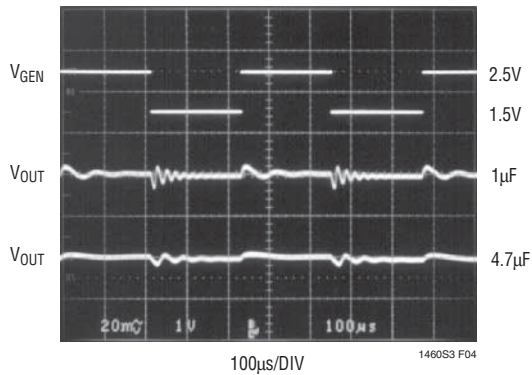

**Figure 4.  $I_{OUT} = 1mA$**

Table 1 gives the maximum output capacitance for various load currents and output voltages to avoid instability. Load capacitors with low ESR (effective series resistance) cause more ringing than capacitors with higher ESR such as polarized aluminum or tantalum capacitors.

**Table 1. Maximum Output Capacitance**

VOLTAGE OPTION	$I_{OUT} = 100\mu A$	$I_{OUT} = 1mA$	$I_{OUT} = 10mA$	$I_{OUT} = 20mA$
2.5V	$>10\mu F$	$>10\mu F$	$2\mu F$	$0.68\mu F$
3V	$>10\mu F$	$>10\mu F$	$2\mu F$	$0.68\mu F$
3.3V	$>10\mu F$	$>10\mu F$	$1\mu F$	$0.68\mu F$
5V	$>10\mu F$	$>10\mu F$	$1\mu F$	$0.68\mu F$
10V	$>10\mu F$	$1\mu F$	$0.15\mu F$	$0.1\mu F$

**Long-Term Drift**

Long-term drift cannot be extrapolated from accelerated high temperature testing. This erroneous technique gives drift numbers that are widely optimistic. The only way long-term drift can be determined is to measure it over the time interval of interest. The LT1460S3 long-term drift data was taken on over 100 parts that were soldered into PC boards similar to a “real world” application. The boards were then placed into a constant temperature oven with  $T_A = 30^\circ C$ , their outputs were scanned regularly and measured with an 8.5 digit DVM. Figure 5 shows typical long-term drift of the LT1460S3s.

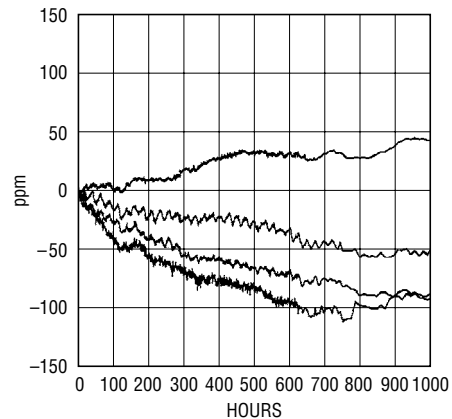

**Figure 5. Typical Long-Term Drift**



## APPLICATIONS INFORMATION

### Hysteresis

Hysteresis data shown in Figure 5 and Figure 6 represents the worst-case data taken on parts from 0°C to 70°C and from -40°C to 85°C. The output is capable of dissipating relatively high power, i.e., for the LT1460S3-2.5,  $P_D = 17.5V \cdot 20mA = 350mW$ . The thermal resistance of the SOT-23 package is 325°C/W and this dissipation causes a 114°C internal rise producing a junction temperature of  $T_J = 25°C + 114°C = 139°C$ . This elevated temperature will cause the output to shift due to thermal hysteresis. **For highest performance in precision applications, do not let the LT1460S3's junction temperature exceed 85°C.**

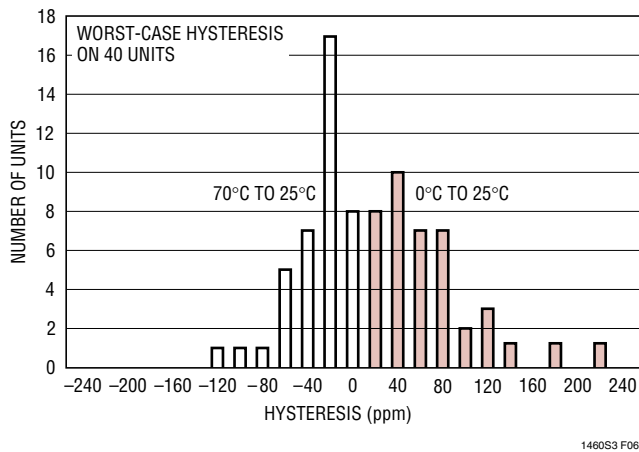

Figure 6. 0°C to 70°C Hysteresis

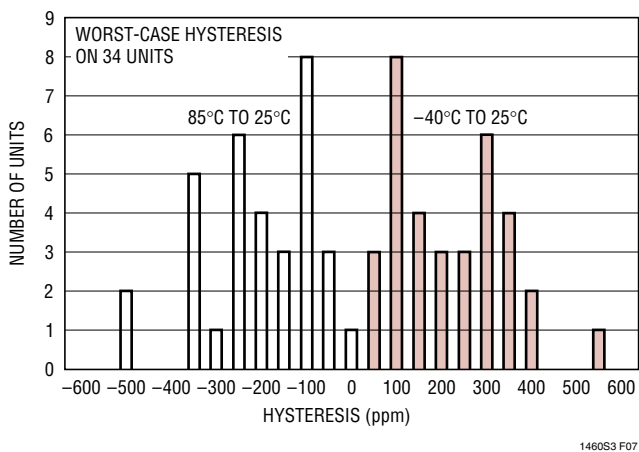

Figure 7. -40°C to 85°C Hysteresis

### Fast Turn-On

It is recommended to add a 0.1μF or larger bypass capacitor to the input pin of the LT1460S3s. Although this can help stability with large load currents, another reason is for proper start-up. The LT1460S3 can start in 10μs, but it is important to limit the dv/dt of the input. Under light load conditions and with a very fast input, internal nodes overslew and this requires finite recovery time. Figure 8 shows the result of no bypass capacitance on the input and no output load on the LT1460S3-5. In this case the supply dv/dt is 7.5V in 30ns which causes internal overslew, and the output does not bias to 5V until 40μs after turn-on. Although 40μs is a typical turn-on time, it can be much longer. Figure 9 shows the effect of a 0.1μF bypass capacitor which limits the input dv/dt to approximately 7.5V in 20μs. The part always starts quickly.

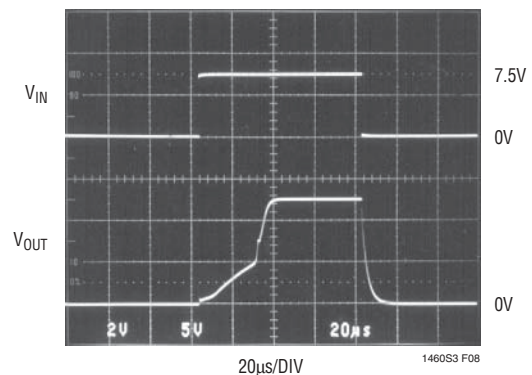

Figure 8.  $C_{IN} = 0\mu F$

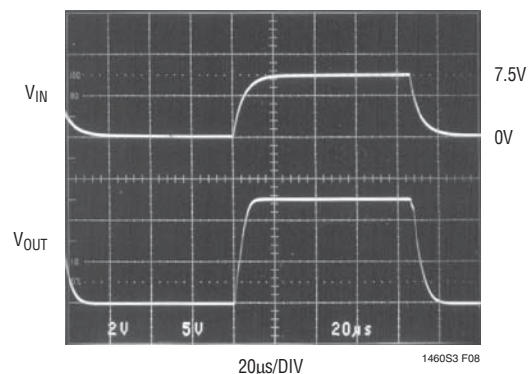

Figure 9.  $C_{IN} = 0.1\mu F$

## APPLICATIONS INFORMATION

### Output Accuracy

Like all references, either series or shunt, the error budget of the LT1460S3s is made up of primarily three components: initial accuracy, temperature coefficient and load regulation. Line regulation is neglected because it typically contributes only 150ppm/V. The LT1460S3s typically shift 0.02% when soldered into a PCB, so this is also neglected. The output errors are calculated as follows for a 100 $\mu$ A load and 0°C to 70°C temperature range:

LT1460HCS3

Initial Accuracy = 0.2%

For  $I_{OUT} = 100\mu A$

$$\Delta V_{OUT} = (4000\text{ppm/mA})(0.1\text{mA}) = 0.04\%$$

For Temperature 0°C to 70°C the maximum  $\Delta T = 70^\circ\text{C}$

$$\Delta V_{OUT} = (20\text{ppm}/^\circ\text{C})(70^\circ\text{C}) = 0.14\%$$

Total worst-case output error is:

$$0.2\% + 0.04\% + 0.14\% = 0.380\%$$

Table 2 gives the worst-case accuracy for LT1460HCS3, LT1460JCS3 and LT1460KCS3 from 0°C to 70°C, and shows that if the LT1460HCS3 is used as a reference instead of a regulator, it is capable of 8 bits of absolute accuracy over temperature without a system calibration.

**Table 2. Worst-Case Output Accuracy over Temperature**

$I_{OUT}$	LT1460HCS3	LT1460JCS3	LT1460KCS3
0 $\mu$ A	0.340%	0.540%	0.850%
100 $\mu$ A	0.380%	0.580%	0.890%
10mA	0.640%	0.840%	1.15%
20mA	0.540%	0.740%	1.05%

**PACKAGE DESCRIPTION**

Dimensions in millimeters (inches) unless otherwise noted.

**S3 Package**  
**3-Lead Plastic SOT-23**  
 (LTC DWG # 05-08-1631)

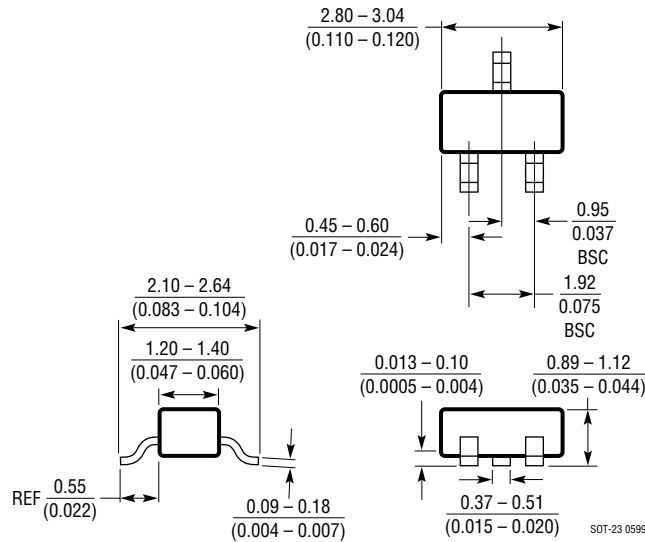

**NOTE:**

1. DIMENSIONS ARE IN MILLIMETERS
2. DIMENSIONS ARE INCLUSIVE OF PLATING
3. DIMENSIONS ARE EXCLUSIVE OF MOLD FLASH AND METAL BURR
4. MOLD FLASH SHALL NOT EXCEED 0.254mm
5. JEDEC REFERENCE IS TO-236 VARIATION AB

## TYPICAL APPLICATIONS

### Handling Higher Load Currents

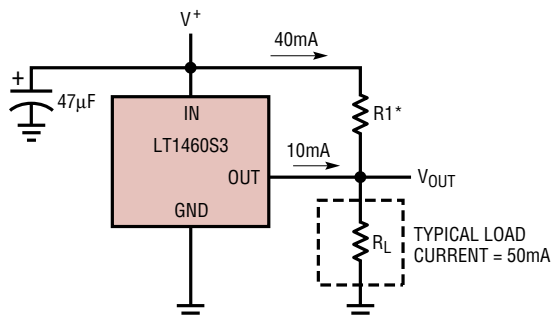

\*SELECT R1 TO DELIVER 80% OF TYPICAL LOAD CURRENT. LT1460 WILL THEN SOURCE AS NECESSARY TO MAINTAIN PROPER OUTPUT. DO NOT REMOVE LOAD AS OUTPUT WILL BE DRIVEN UNREGULATED HIGH. LINE REGULATION IS DEGRADED IN THIS APPLICATION

$$R1 = \frac{V^+ - V_{OUT}}{40mA}$$

1460S3 TA05

### Boosted Output Current with No Current Limit

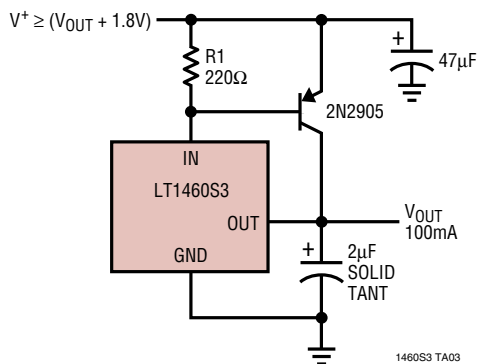

1460S3 TA03

### Boosted Output Current with Current Limit

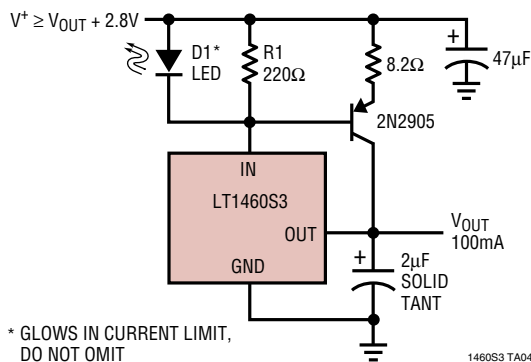

\* GLOWS IN CURRENT LIMIT, DO NOT OMIT

1460S3 TA04

## RELATED PARTS

PART NUMBER	DESCRIPTION	COMMENTS
LT1019	Precision Bandgap Reference	0.05% Max, 5ppm/°C Max
LT1027	Precision 5V Reference	0.02%, 2ppm/°C Max
LT1236	Precision Low Noise Reference	0.05% Max, 5ppm/°C Max, SO Package
LT1461	Micropower Precision Low Dropout	0.04% Max, 3ppm/°C Max, 50mA Output Current
LT1634	Micropower Precision Shunt Reference 1.25V, 2.5V Output	0.05%, 25ppm/°C Max
LTC1798	Micropower Low Dropout Reference, Fixed or Adjustable	0.15% Max, 40ppm/°C, 6.5µA Max Supply Current