

TOSHIBA MOS DIGITAL INTEGRATED CIRCUIT SILICON GATE CMOS

262,144-WORD BY 16-BIT STATIC RAM

**DESCRIPTION**

The TC554161FTI is a 4,194,304-bit static random access memory (SRAM) organized as 262,144 words by 16 bits. Fabricated using Toshiba's CMOS Silicon gate process technology, this device operates from a single 5 V ± 10% power supply. Advanced circuit technology provides both high speed and low power at an operating current of 10 mA/MHz (typ) and a minimum cycle time of 85 ns. It is automatically placed in low-power mode at 200 μA standby current (max) when chip enable ( $\overline{CE}$ ) is asserted high. There are two control inputs.  $\overline{CE}$  is used to select the device and for data retention control, and output enable ( $\overline{OE}$ ) provides fast memory access. Data byte control pin ( $\overline{LB}$ ,  $\overline{UB}$ ) provides lower and upper byte access. This device is well suited to various microprocessor system applications where high speed, low power and battery backup are required. And, with a guaranteed operating range of - 40° to 85°C, the TC554161FTI can be used in environments exhibiting extreme temperature conditions. The TC554161FTI is available in a plastic 54-pin thin-small-outline package (TSOP).

**FEATURES**

- Low-power dissipation  
Operating: 55 mW/MHz(typical)
- Standby current of 200 μA (maximum)
- Single power supply voltage of 5 V ± 10%
- Power down features using  $\overline{CE}$ .
- Data retention supply voltage of 2 to 5.5 V
- Direct TTL compatibility for all inputs and outputs
- Wide operating temperature range of - 40° to 85°C

● Access Times (maximum):

	TC554161FTI	
	-85	-10
Access Time	85 ns	100 ns
$\overline{CE}$ Access Time	85 ns	100 ns
$\overline{OE}$ Access Time	45 ns	50 ns

● Package:

TSOP II 54-P-400-0.80 (FTI) (Weight: 0.55 g typ)

**PIN ASSIGNMENT (TOP VIEW)**

NC	1	○	54	□	A4
A3	2		53	□	A5
A2	3		52	□	A6
A1	4		51	□	A7
A0	5		50	□	NC
I/O16	6		49	□	I/O1
I/O15	7		48	□	I/O2
V <sub>DD</sub>	8		47	□	V <sub>DD</sub>
GND	9		46	□	GND
I/O14	10		45	□	I/O3
I/O13	11		44	□	I/O4
$\overline{UB}$	12		43	□	$\overline{LB}$
$\overline{CE}$	13		42	□	$\overline{OE}$
OP	14		41	□	OP
R/W	15		40	□	NC
I/O12	16		39	□	I/O5
I/O11	17		38	□	I/O6
GND	18		37	□	GND
V <sub>DD</sub>	19		36	□	V <sub>DD</sub>
I/O10	20		35	□	I/O7
I/O9	21		34	□	I/O8
NC	22		33	□	A8
A17	23		32	□	A9
A16	24		31	□	A10
A15	25		30	□	A11
A14	26		29	□	A12
A13	27		28	□	NC

(Normal pinout)

**PIN NAMES**

A0 to A17	Address Inputs
I/O1 to I/O16	Data Inputs/Outputs
$\overline{CE}$	Chip Enable
R/W	Read/Write Control
$\overline{OE}$	Output Enable
$\overline{LB}$ , $\overline{UB}$	Data Byte Control Input
V <sub>DD</sub>	Power (+ 5 V)
GND	Ground
NC	No Connection
OP*	Option

\*: OP pin must be open or connected to GND.

961001EBA1

- TOSHIBA is continually working to improve the quality and the reliability of its products. Nevertheless, semiconductor devices in general can malfunction or fail due to their inherent electrical sensitivity and vulnerability to physical stress. It is the responsibility of the buyer, when utilizing TOSHIBA products, to observe standards of safety, and to avoid situations in which a malfunction or failure of a TOSHIBA product could cause loss of human life, bodily injury or damage to property. In developing your designs, please ensure that TOSHIBA products are used within specified operating ranges as set forth in the most recent products specifications. Also, please keep in mind the precautions and conditions set forth in the TOSHIBA Semiconductor Reliability Handbook.
- The products described in this document are subject to foreign exchange and foreign trade control laws.
- The information contained herein is presented only as a guide for the applications of our products. No responsibility is assumed by TOSHIBA CORPORATION for any infringements of intellectual property or other rights of the third parties which may result from its use. No license is granted by implication or otherwise under any intellectual property or other rights of TOSHIBA CORPORATION or others.
- The information contained herein is subject to change without notice.

**BLOCK DIAGRAM**

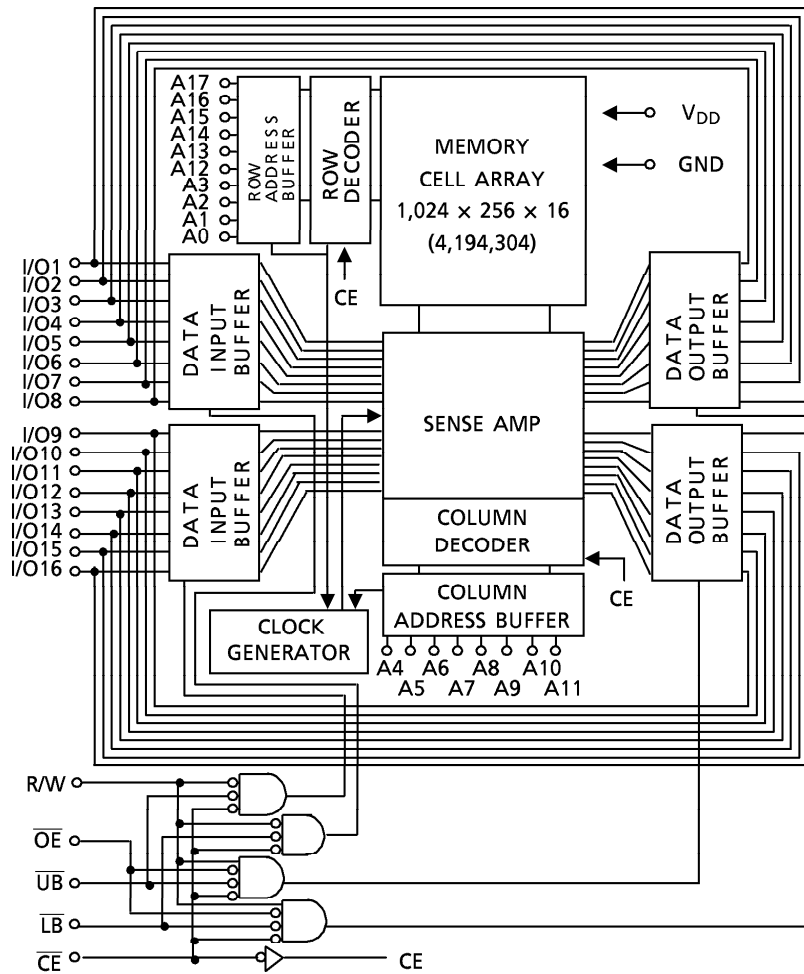

**MAXIMUM RATINGS**

SYMBOL	RATING	VALUE	UNIT
$V_{DD}$	Power Supply Voltage	- 0.3 to 7.0	V
$V_{IN}$	Input Voltage	- 0.3 * to 7.0	V
$V_{I/O}$	Input/Output Voltage	- 0.5 to $V_{DD} + 0.5$	V
$P_D$	Power Dissipation	0.6	W
$T_{solder}$	Soldering Temperature (10 s)	260	°C
$T_{strg}$	Storage Temperature	- 55 to 150	°C
$T_{opr}$	Operating Temperature	- 40 to 85	°C

\* - 3.0 V when measured at a pulse width of 30 ns

**DC RECOMMENDED OPERATING CONDITIONS ( $T_a = - 40^\circ$  to  $85^\circ\text{C}$ )**

SYMBOL	PARAMETER	MIN	TYP	MAX	UNIT
$V_{DD}$	Power Supply Voltage	4.5	5.0	5.5	V
$V_{IH}$	Input High Voltage	2.4	-	$V_{DD} + 0.3$	V
$V_{IL}$	Input Low Voltage	- 0.3 *	-	0.6	V
$V_{DH}$	Data Retention Supply Voltage	2.0	-	5.5	V

\* - 3.0 V when measured at a pulse width of 30 ns

**DC CHARACTERISTICS** (Ta = - 40° to 85°C, VDD = 5 V ± 10%)

SYMBOL	PARAMETER	TEST CONDITION	MIN	TYP	MAX	UNIT		
I <sub>IL</sub>	Input Leakage Current	V <sub>IN</sub> = 0 V to V <sub>DD</sub>	-	-	± 1.0	μA		
I <sub>LO</sub>	Output Leakage Current	$\overline{CE} = V_{IH}$ or R/W = V <sub>IL</sub> or $\overline{OE} = V_{IH}$ V <sub>OUT</sub> = 0 V to V <sub>DD</sub>	-	-	± 1.0	μA		
I <sub>OH</sub>	Output High Current	V <sub>OH</sub> = 2.4 V	- 1.0	-	-	mA		
I <sub>OL</sub>	Output Low Current	V <sub>OL</sub> = 0.4 V	2.1	-	-	mA		
I <sub>DDO 1</sub>	Operating Current	$\overline{CE} = V_{IL}$ R/W = V <sub>IH</sub> , I <sub>OUT</sub> = 0 mA Other Inputs = V <sub>IH</sub> /V <sub>IL</sub>	Tcycle	min	-	-	100	mA
				1 μs	-	15	-	
I <sub>DDO 2</sub>	Operating Current	$\overline{CE} = 0.2 V$ R/W = V <sub>DD</sub> - 0.2 V, I <sub>OUT</sub> = 0 mA Other Inputs = V <sub>DD</sub> - 0.2 V/0.2 V	Tcycle	min	-	-	90	mA
				1 μs	-	10	-	
I <sub>DDS 1</sub>	Standby Current	$\overline{CE} = V_{IH}$	-	-	3	mA		
I <sub>DDS 2</sub>		$\overline{CE} = V_{DD} - 0.2 V$ , Ta = - 40° to 85°C V <sub>DD</sub> = 2.0 to 5.5 V	-	-	200	μA		

**CAPACITANCE** (Ta = 25°C, f = 1 MHz)

SYMBOL	PARAMETER	TEST CONDITION	MAX	UNIT
C <sub>IN</sub>	Input Capacitance	V <sub>IN</sub> = GND	10	pF
C <sub>OUT</sub>	Output Capacitance	V <sub>OUT</sub> = GND	10	pF

Note: This parameter is periodically sampled and is not 100% tested.

**OPERATING MODE**

MODE	$\overline{CE}$	$\overline{OE}$	R/W	$\overline{LB}$	$\overline{UB}$	I/O1 to I/O8	I/O9 to I/O16	POWER
Read	L	L	H	L	L	Output	Output	I <sub>DDO</sub>
				H	L	High-Z	Output	I <sub>DDO</sub>
				L	H	Output	High-Z	I <sub>DDO</sub>
Write	L	x	L	L	L	Input	Input	I <sub>DDO</sub>
				H	L	High-Z	Input	I <sub>DDO</sub>
				L	H	Input	High-Z	I <sub>DDO</sub>
Outputs Disable	L	H	H	x	x	High-Z	High-Z	I <sub>DDO</sub>
	L	x	x	H	H			
Standby	H	x	x	x	x	High-Z	High-Z	I <sub>DDS</sub>

x = don't care  
H = logic high  
L = logic low

**AC CHARACTERISTICS AND OPERATING CONDITIONS (Ta = - 40° to 85°C, VDD = 5 V ± 10%)**

**READ CYCLE**

SYMBOL	PARAMETER	TC554161FTI				UNIT
		-85		-10		
		MIN	MAX	MIN	MAX	
t <sub>RC</sub>	Read Cycle Time	85	-	100	-	ns
t <sub>ACC</sub>	Address Access Time	-	85	-	100	
t <sub>CO</sub>	Chip Enable Access Time	-	85	-	100	
t <sub>OE</sub>	Output Enable Access Time	-	45	-	50	
t <sub>BA</sub>	Data Byte Control Access Time	-	45	-	50	
t <sub>OH</sub>	Output Data Hold Time	10	-	10	-	
t <sub>COE</sub>	Chip Enable Low to Output Active	5	-	5	-	
t <sub>OEE</sub>	Output Enable Low to Output Active	0	-	0	-	
t <sub>BE</sub>	Data Byte Control Low to Output Active	0	-	0	-	
t <sub>OD</sub>	Chip Enable High to Output High-Z	-	35	-	40	
t <sub>ODO</sub>	Output Enable High to Output High-Z	-	35	-	40	
t <sub>BD</sub>	Data Byte Control High to Output High-Z	-	35	-	40	

**WRITE CYCLE**

SYMBOL	PARAMETER	TC554161FTI				UNIT
		-85		-10		
		MIN	MAX	MIN	MAX	
t <sub>WC</sub>	Write Cycle Time	85	-	100	-	ns
t <sub>WP</sub>	Write Pulse Width	55	-	60	-	
t <sub>CW</sub>	Chip Enable to End of Write	70	-	80	-	
t <sub>BW</sub>	Data Byte Control to End of Write	55	-	60	-	
t <sub>AS</sub>	Address Setup Time	0	-	0	-	
t <sub>WR</sub>	Write Recovery Time	0	-	0	-	
t <sub>DS</sub>	Data Setup Time	35	-	40	-	
t <sub>DH</sub>	Data Hold Time	0	-	0	-	
t <sub>OEW</sub>	R/W High to Output Active	0	-	0	-	
t <sub>ODW</sub>	R/W Low to Output High-Z	-	35	-	40	

**AC TEST CONDITIONS**

Output load: 100 pF + one TTL gate

Input pulse level: 0.4 V, 2.6 V

Timing measurements: 1.5 V

Reference level: 1.5 V

t<sub>R</sub>, t<sub>F</sub>: 5 ns

TIMING DIAGRAMS

READ CYCLE (See Note 1)

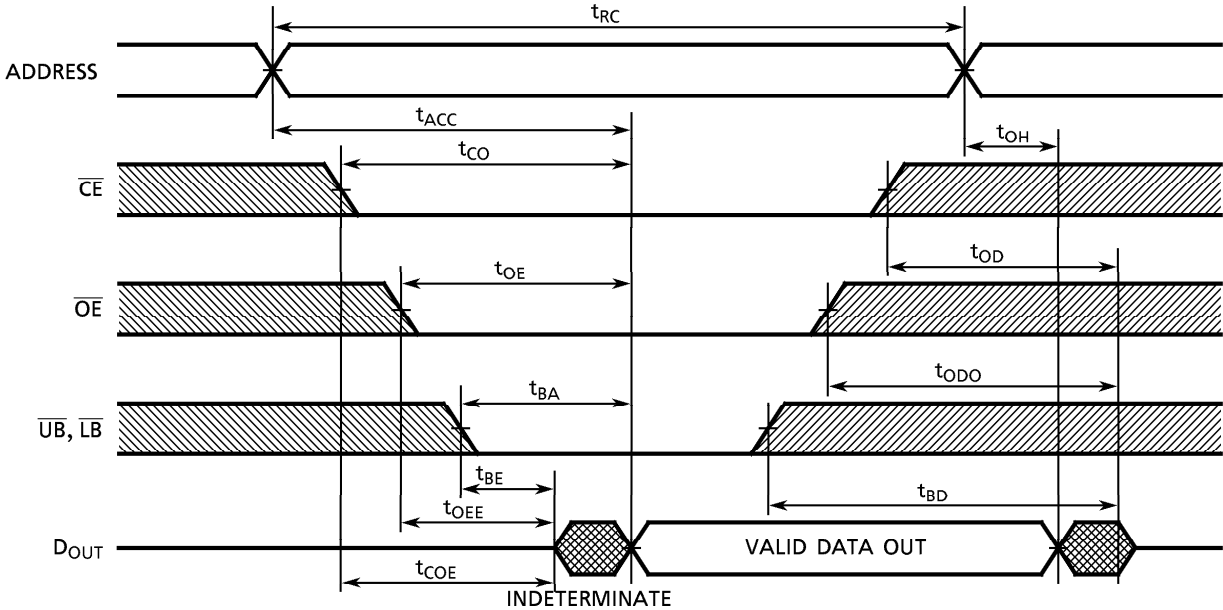

WRITE CYCLE 1 (R/W CONTROLLED) (See Note 4)

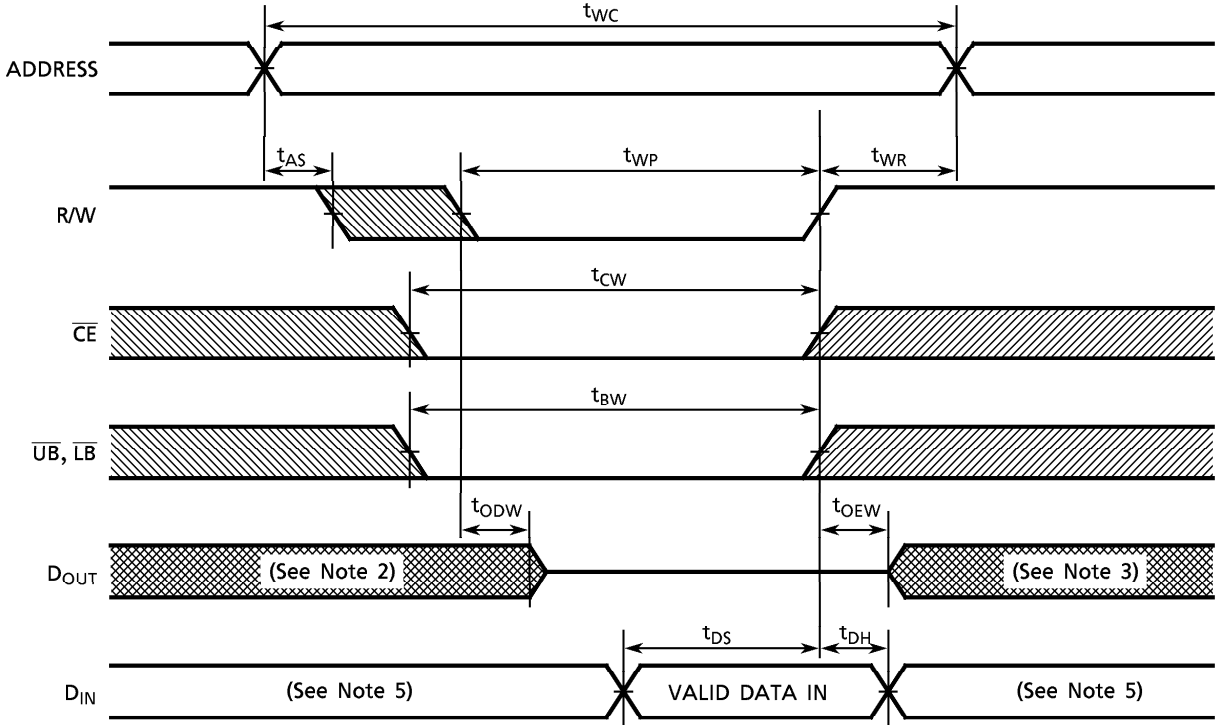

WRITE CYCLE 2 ( $\overline{CE}$  CONTROLLED) (See Note 4)

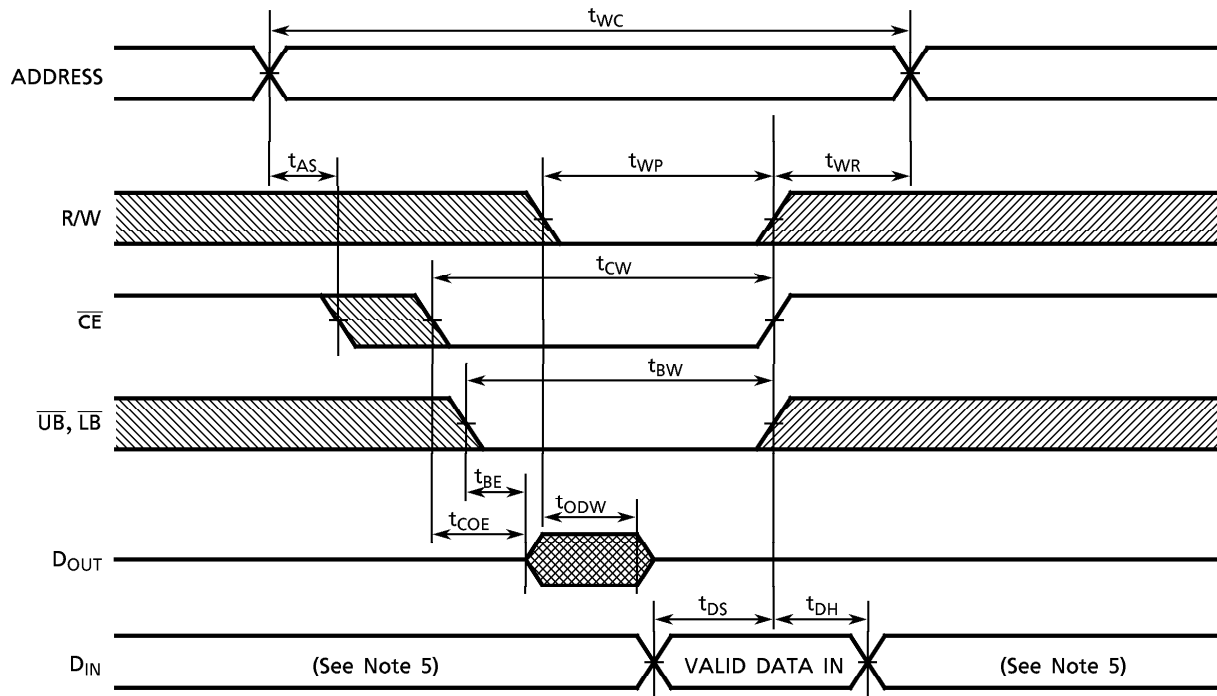

WRITE CYCLE 3 ( $\overline{UB}$ ,  $\overline{LB}$  CONTROLLED) (See Note 4)

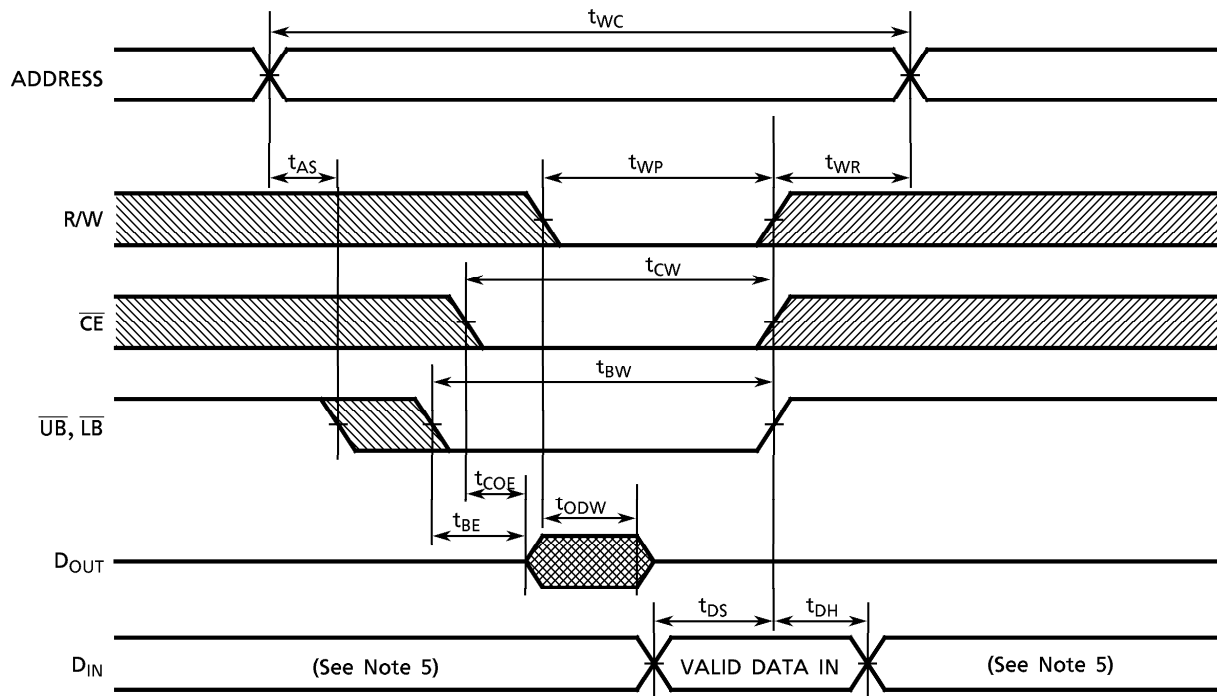

Note: (1) R/W remains HIGH for the read cycle.

(2) If  $\overline{CE}$  goes LOW coincident with or after R/W goes LOW, the outputs will remain at high impedance.

(3) If  $\overline{CE}$  goes HIGH coincident with or before R/W goes HIGH, the outputs will remain at high impedance.

(4) If  $\overline{OE}$  is HIGH during the write cycle, the outputs will remain at high impedance.

(5) Because I/O signals may be in the output state at this time, input signals of reverse polarity must not be applied.

**DATA RETENTION CHARACTERISTICS (Ta = - 40° to 85°C)**

SYMBOL	PARAMETER	MIN	TYP	MAX	UNIT
V <sub>DH</sub>	Data Retention Supply Voltage	2.0	-	5.5	V
I <sub>DDS2</sub>	Standby Current	V <sub>DH</sub> = 3.0 V	-	100	μA
		V <sub>DH</sub> = 5.5 V	-	200	
t <sub>CDR</sub>	Chip Deselect to Data Retention Mode Time	0	-	-	nS
t <sub>R</sub>	Recovery Time	5	-	-	mS

**CE CONTROLLED DATA RETENTION MODE**

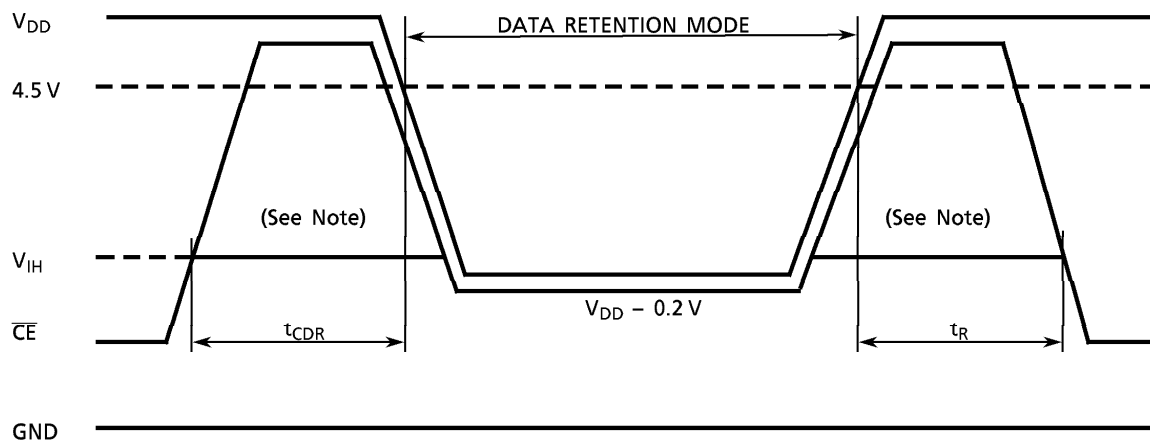

Note: When  $\overline{CE}$  is operating at the V<sub>IH</sub> level (2.4 V), the operating current is given by I<sub>DDS1</sub> during the transition of V<sub>DD</sub> from 4.5 to 2.6 V.



PACKAGE DIMENSIONS (TSOPII 54-P-400-0.80)

Units in mm

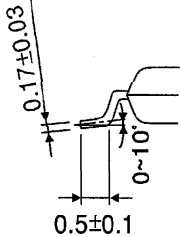
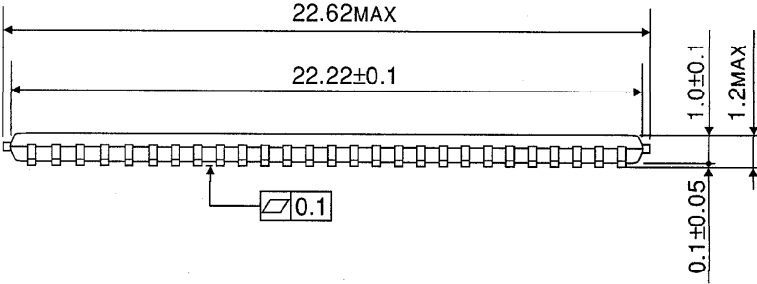
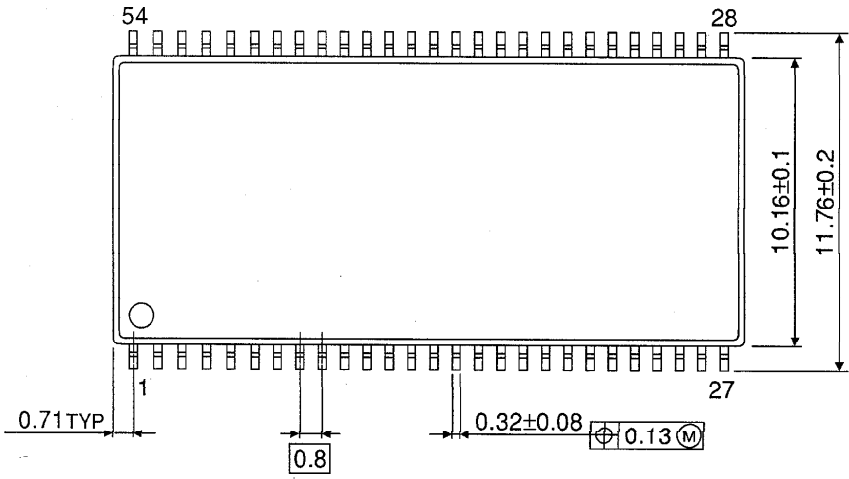

Weight: 0.55 g (typ)