

UPR5 Series

Surface Mount Ultrafast Power Rectifiers

POWERMITE® Power Surface Mount Package

Ideally suited for high voltage, high frequency rectification, or as free wheeling and protection diodes in surface mount applications where compact size and weight are critical to the system.

Features:

- Low Profile – Maximum Height of 1.1 mm
- Small Footprint – Footprint Area of 8.45 mm²
- Supplied in 12 mm Tape and Reel
 - TR7 Suffix = 3,000 Units per Reel
 - TR13 Suffix = 12,000 Units per Reel
- Low Thermal Resistance with Direct Thermal Path of Die on Exposed Cathode Heat Sink

Mechanical Characteristics:

- Powermite is JEDEC Registered as D0–216AA
- Case: Molded Epoxy
- Epoxy Meets UL94, VO at 1/8"
- Weight: 62 mg (approximately)
- ESD Ratings: Machine Model = C
Human Body Model = 3B
- Lead and Mounting Surface Temperature for Soldering Purposes.
260°C Maximum for 10 Seconds

MAXIMUM RATINGS

Rating	Symbol	Value	Unit
Peak Repetitive Reverse Voltage Working Peak Reverse Voltage DC Blocking Voltage	V_{RRM} V_{RWM} V_R	50 100	V
Average Rectified Forward Current (At Rated V_R , $T_L = 95^\circ\text{C}$)	$I_{F(AV)}$	2.0	A
Non–Repetitive Peak Surge Current (Surge applied at rated load conditions halfwave, single phase, 60 Hz)	I_{FSM}	50	A
Operating Junction Temperature Range	T_J	–65 to +150	°C
Storage Temperature Range	T_{stg}	–65 to +150	°C



ON Semiconductor™

<http://onsemi.com>

**ULTRAFAST
RECTIFIERS
2.0 AMPERES
100 VOLTS**

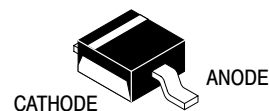

**POWERMITE
CASE 457
PLASTIC**

MARKING DIAGRAM

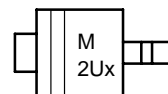

M = Date Code
x = A or B
2UA = UPR5 Series Device Code
2UB = UPR10 Series Device Code

ORDERING INFORMATION

Device	Package	Shipping
UPR5TR7	POWERMITE	3,000/Tape & Reel
UPR5TR13	POWERMITE	12,000/Tape & Reel
UPR10TR7	POWERMITE	3,000/Tape & Reel
UPR10TR13	POWERMITE	12,000/Tape & Reel

UPR5 Series

THERMAL CHARACTERISTICS

Rating	Symbol	Value	Unit
Thermal Resistance – Junction-to-Lead (Anode) (Note 1)	R_{tjl}	35	°C/W
– Junction-to-Tab (Cathode) (Note 1)	R_{tjtab}	23	
– Junction-to-Ambient (Note 1)	R_{tja}	277	

ELECTRICAL CHARACTERISTICS ($T_A = 25^\circ\text{C}$ unless otherwise noted)

Maximum Instantaneous Forward Voltage ($I_F = 1.0\text{ A}$) ($I_F = 2.0\text{ A}$)	V_F	$T_J = 25^\circ\text{C}$	$T_J = 100^\circ\text{C}$	V
		0.830 0.905	0.680 0.740	
Maximum Instantaneous Reverse Current ($V_R = \text{Max Rating}$)	I_R	$T_J = 25^\circ\text{C}$	$T_J = 100^\circ\text{C}$	μA
		2.0	50	
Maximum Reverse Recovery Time ($I_F = 1.0\text{ A}$, $di/dt = 50\text{ A}/\mu\text{s}$, $V_R = 30\text{ V}$, $T_J = 25^\circ\text{C}$)	T_{RR}	30		ns
Typical Reverse Recovery Time ($I_F = 0.1\text{ A}$, $I_R = 0.2\text{ A}$, $I_{REC} = 50\text{ mA}$)	T_{RR}	6		ns

1. Mounted with minimum recommended pad size, PC Board FR4. See Figures 7 and 8.

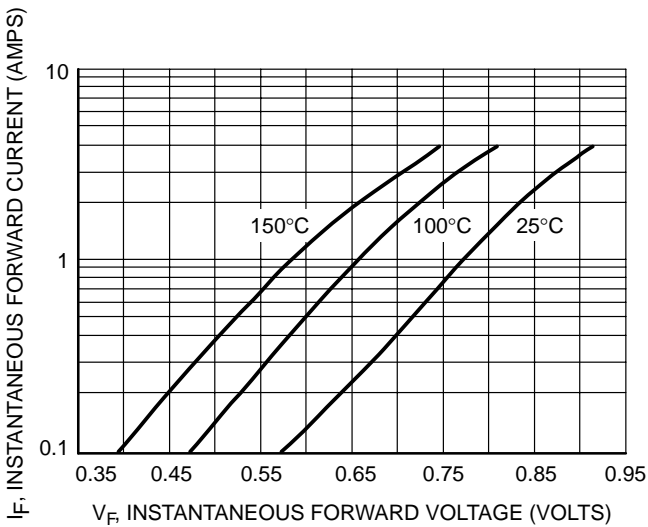

Figure 1. Typical Forward Voltage

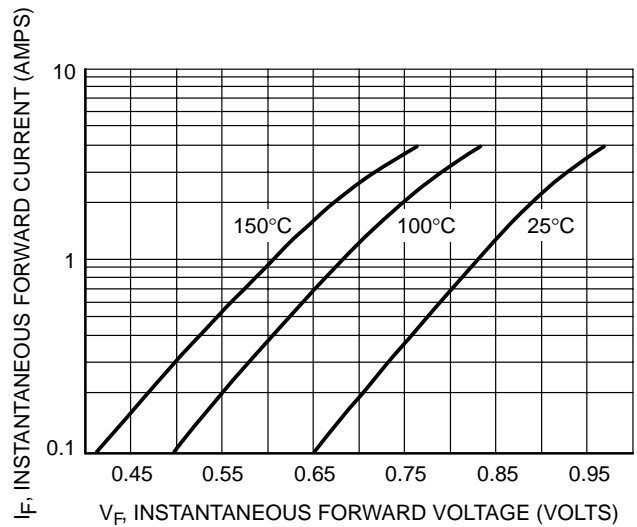

Figure 2. Maximum Forward Voltage

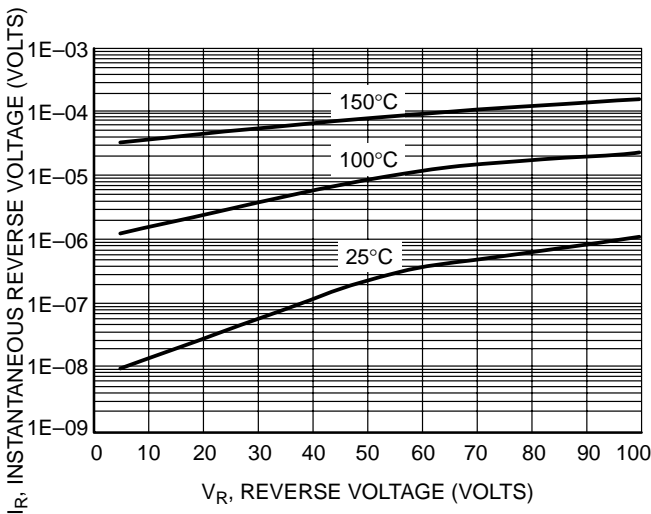

Figure 3. Typical Reverse Current

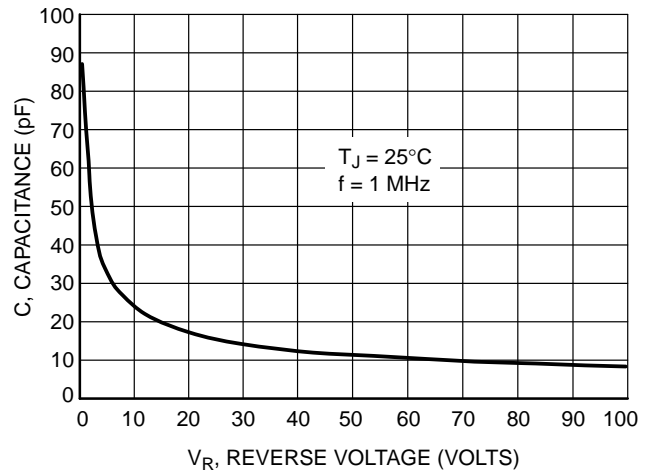

Figure 4. Typical Capacitance

UPR5 Series

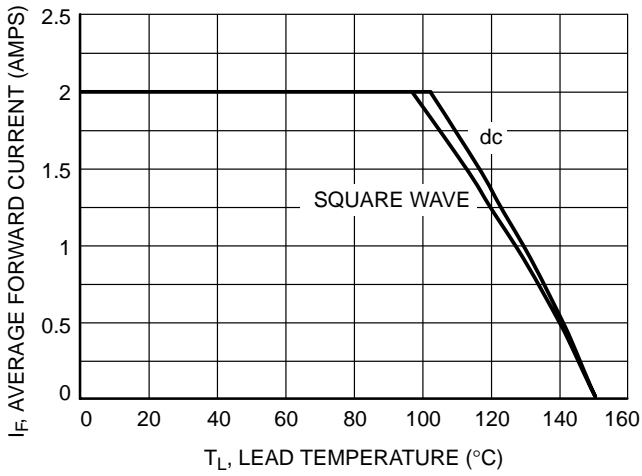

Figure 5. Current Derating – Lead

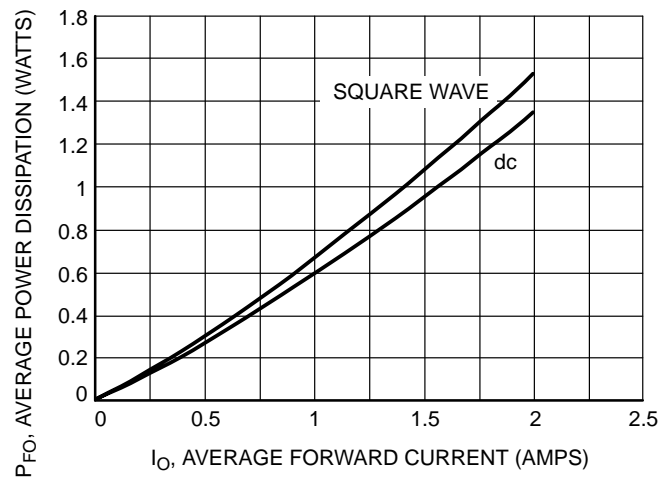

Figure 6. Forward Power Dissipation

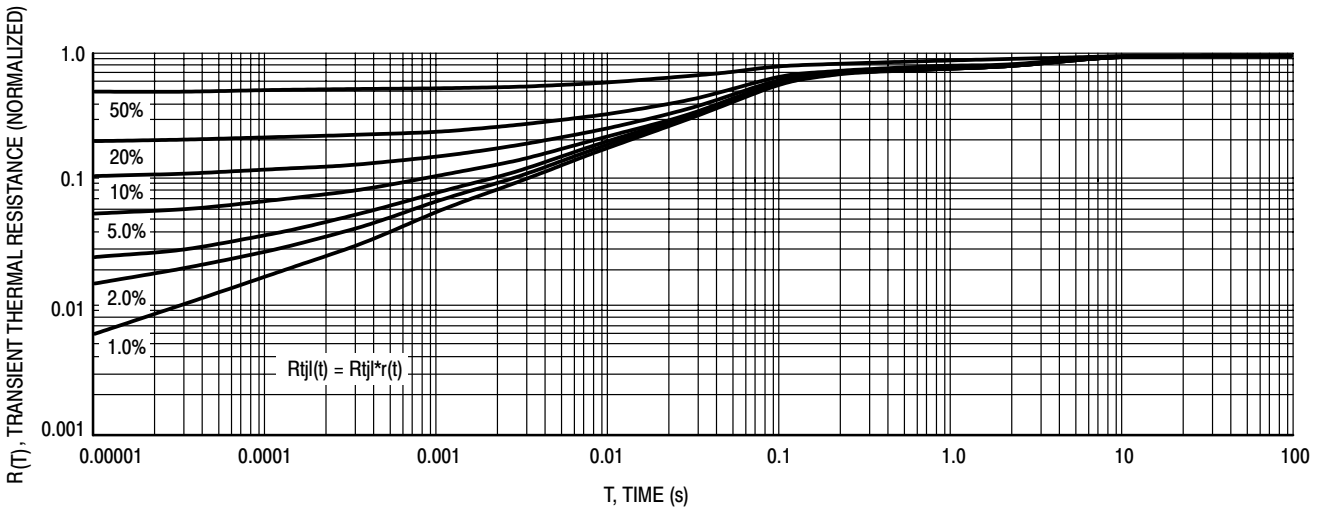

Figure 7. Thermal Response Junction to Lead

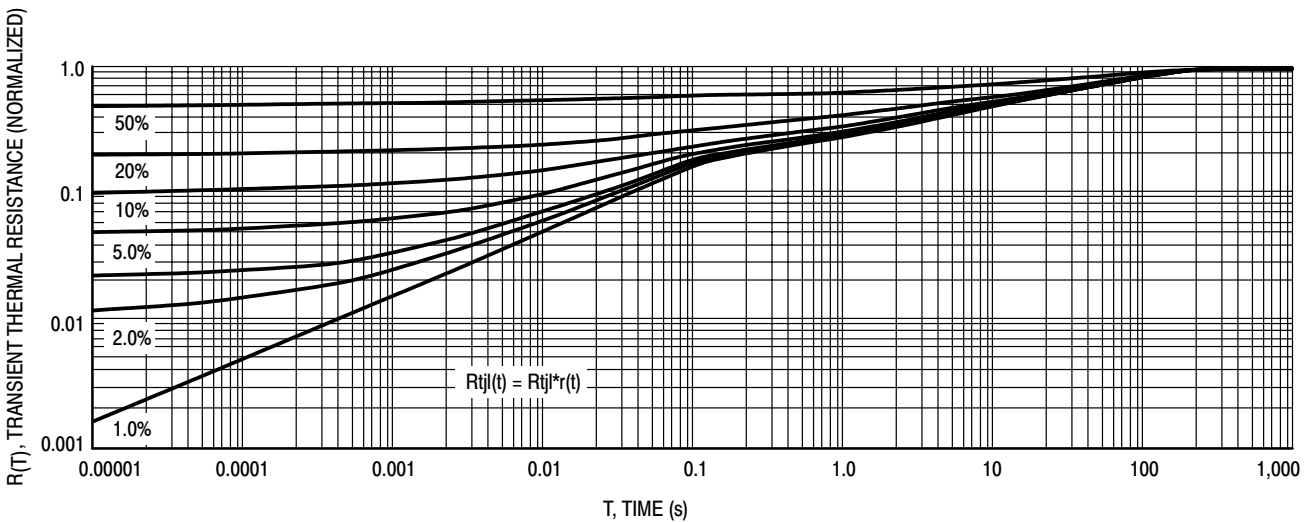
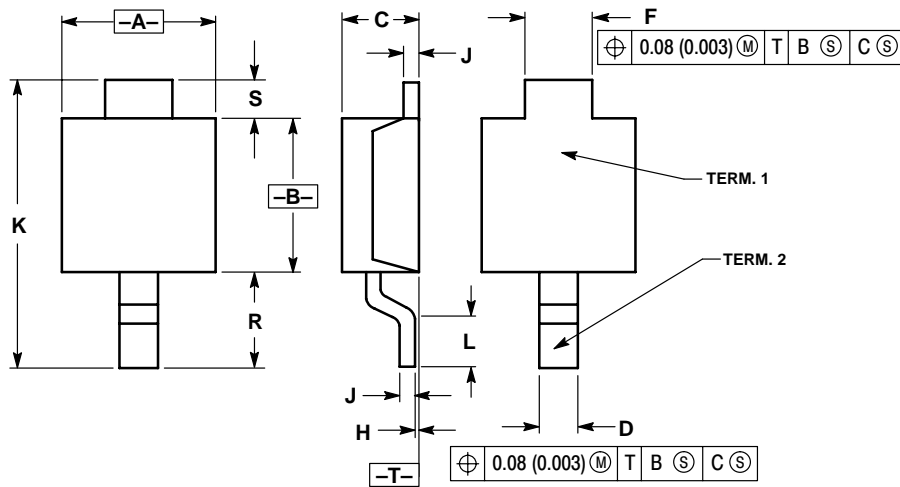

Figure 8. Thermal Response Junction to Ambient

UPR5 Series

PACKAGE DIMENSIONS

POWERMITE
CASE 457-04
ISSUE D



NOTES:

1. DIMENSIONING AND TOLERANCING PER ANSI Y14.5M, 1982.
2. CONTROLLING DIMENSION: MILLIMETER.
3. DIMENSION A DOES NOT INCLUDE MOLD FLASH, PROTRUSIONS OR GATE BURRS. MOLD FLASH, PROTRUSIONS OR GATE BURRS SHALL NOT EXCEED 0.15 (0.006) PER SIDE.

DIM	MILLIMETERS		INCHES	
	MIN	MAX	MIN	MAX
A	1.75	2.05	0.069	0.081
B	1.75	2.18	0.069	0.086
C	0.85	1.15	0.033	0.045
D	0.40	0.69	0.016	0.027
F	0.70	1.00	0.028	0.039
H	-0.05	+0.10	-0.002	+0.004
J	0.10	0.25	0.004	0.010
K	3.60	3.90	0.142	0.154
L	0.50	0.80	0.020	0.031
R	1.20	1.50	0.047	0.059
S	0.50	REF	0.019	REF

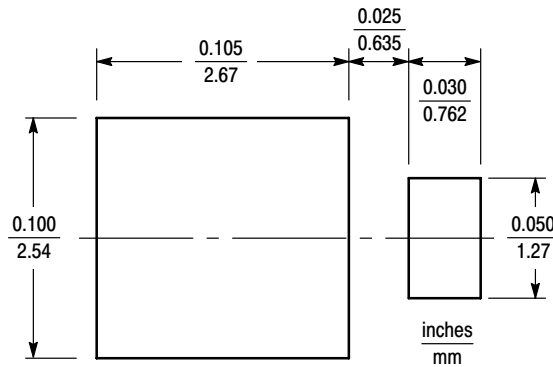

Minimum Recommended Footprint

POWERMITE is a registered trademark of and used under a license from MicroSemi Corporation

ON Semiconductor and  are trademarks of Semiconductor Components Industries, LLC (SCILLC). SCILLC reserves the right to make changes without further notice to any products herein. SCILLC makes no warranty, representation or guarantee regarding the suitability of its products for any particular purpose, nor does SCILLC assume any liability arising out of the application or use of any product or circuit, and specifically disclaims any and all liability, including without limitation special, consequential or incidental damages. "Typical" parameters which may be provided in SCILLC data sheets and/or specifications can and do vary in different applications and actual performance may vary over time. All operating parameters, including "Typicals" must be validated for each customer application by customer's technical experts. SCILLC does not convey any license under its patent rights nor the rights of others. SCILLC products are not designed, intended, or authorized for use as components in systems intended for surgical implant into the body, or other applications intended to support or sustain life, or for any other application in which the failure of the SCILLC product could create a situation where personal injury or death may occur. Should Buyer purchase or use SCILLC products for any such unintended or unauthorized application, Buyer shall indemnify and hold SCILLC and its officers, employees, subsidiaries, affiliates, and distributors harmless against all claims, costs, damages, and expenses, and reasonable attorney fees arising out of, directly or indirectly, any claim of personal injury or death associated with such unintended or unauthorized use, even if such claim alleges that SCILLC was negligent regarding the design or manufacture of the part. SCILLC is an Equal Opportunity/Affirmative Action Employer.

PUBLICATION ORDERING INFORMATION

Literature Fulfillment:

Literature Distribution Center for ON Semiconductor
P.O. Box 5163, Denver, Colorado 80217 USA
Phone: 303-675-2175 or 800-344-3860 Toll Free USA/Canada
Fax: 303-675-2176 or 800-344-3867 Toll Free USA/Canada
Email: ONlit@hibbertco.com

N. American Technical Support: 800-282-9855 Toll Free USA/Canada

JAPAN: ON Semiconductor, Japan Customer Focus Center
4-32-1 Nishi-Gotanda, Shinagawa-ku, Tokyo, Japan 141-0031
Phone: 81-3-5740-2700
Email: r14525@onsemi.com

ON Semiconductor Website: <http://onsemi.com>

For additional information, please contact your local Sales Representative.