

P6SMB6.8AT3 Series

600 Watt Peak Power Zener Transient Voltage Suppressors

Unidirectional*

The SMB series is designed to protect voltage sensitive components from high voltage, high energy transients. They have excellent clamping capability, high surge capability, low zener impedance and fast response time. The SMB series is supplied in ON Semiconductor's exclusive, cost-effective, highly reliable Surmetic™ package and is ideally suited for use in communication systems, automotive, numerical controls, process controls, medical equipment, business machines, power supplies and many other industrial/consumer applications.

Specification Features:

- Working Peak Reverse Voltage Range – 5.8 to 171 V
- Standard Zener Breakdown Voltage Range – 6.8 to 200 V
- Peak Power – 600 Watts @ 1 ms
- ESD Rating of Class 3 (>16 KV) per Human Body Model
- Maximum Clamp Voltage @ Peak Pulse Current
- Low Leakage < 5 μ A Above 10 V
- UL 497B for Isolated Loop Circuit Protection
- Response Time is Typically < 1 ns

Mechanical Characteristics:

CASE: Void-free, transfer-molded, thermosetting plastic

FINISH: All external surfaces are corrosion resistant and leads are readily solderable

MAXIMUM CASE TEMPERATURE FOR SOLDERING PURPOSES:
260°C for 10 Seconds

LEADS: Modified L-Bend providing more contact area to bond pads

POLARITY: Cathode indicated by polarity band

MOUNTING POSITION: Any

MAXIMUM RATINGS

Please See the Table on the Following Page

*Please see P6SMB11CAT3 to P6SMB91CAT3 for Bidirectional devices.



ON Semiconductor™

<http://onsemi.com>

**PLASTIC SURFACE MOUNT
ZENER OVERVOLTAGE
TRANSIENT SUPPRESSORS
5.8–171 VOLTS
600 WATT PEAK POWER**

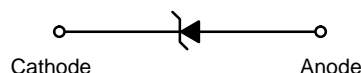

**SMB
CASE 403A
PLASTIC**

MARKING DIAGRAM



Y = Year
WW = Work Week
xxxA = Specific Device Code
(See Table on Page 3)

ORDERING INFORMATION

Device †	Package	Shipping
P6SMBxxxAT3	SMB	2500/Tape & Reel

Devices listed in **bold, italic** are ON Semiconductor **Preferred** devices. **Preferred** devices are recommended choices for future use and best overall value.

†The "T3" suffix refers to a 13 inch reel.

P6SMB6.8AT3 Series

MAXIMUM RATINGS

Rating	Symbol	Value	Unit
Peak Power Dissipation (Note 1.) @ $T_L = 25^\circ\text{C}$, Pulse Width = 1 ms	P_{PK}	600	W
DC Power Dissipation @ $T_L = 75^\circ\text{C}$ Measured Zero Lead Length (Note 2.) Derate Above 75°C	P_D	3.0	W
Thermal Resistance from Junction to Lead	$R_{\theta JL}$	40	mW/ $^\circ\text{C}$
Thermal Resistance from Junction to Ambient	$R_{\theta JA}$	25	$^\circ\text{C}/\text{W}$
DC Power Dissipation (Note 3.) @ $T_A = 25^\circ\text{C}$ Derate Above 25°C	P_D	0.55	W
Thermal Resistance from Junction to Ambient	$R_{\theta JA}$	4.4	mW/ $^\circ\text{C}$
Thermal Resistance from Junction to Ambient	$R_{\theta JA}$	226	$^\circ\text{C}/\text{W}$
Forward Surge Current (Note 4.) @ $T_A = 25^\circ\text{C}$	I_{FSM}	100	A
Operating and Storage Temperature Range	T_J, T_{stg}	-65 to +150	$^\circ\text{C}$

- 10 X 1000 μs , non-repetitive
- 1" square copper pad, FR-4 board
- FR-4 board, using ON Semiconductor minimum recommended footprint, as shown in 403A case outline dimensions spec.
- 1/2 sine wave (or equivalent square wave), PW = 8.3 ms, duty cycle = 4 pulses per minute maximum.

ELECTRICAL CHARACTERISTICS

($T_A = 25^\circ\text{C}$ unless otherwise noted, $V_F = 3.5\text{ V Max.}$ @ I_F (Note 4) = 30 A) (Note 5.)

Symbol	Parameter
I_{PP}	Maximum Reverse Peak Pulse Current
V_C	Clamping Voltage @ I_{PP}
V_{RWM}	Working Peak Reverse Voltage
I_R	Maximum Reverse Leakage Current @ V_{RWM}
V_{BR}	Breakdown Voltage @ I_T
I_T	Test Current
Θ_{VBR}	Maximum Temperature Coefficient of V_{BR}
I_F	Forward Current
V_F	Forward Voltage @ I_F

- 1/2 sine wave or equivalent, PW = 8.3 ms, non-repetitive duty cycle

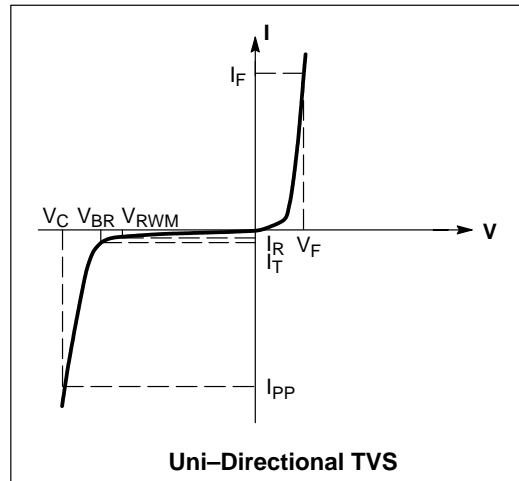

P6SMB6.8AT3 Series

ELECTRICAL CHARACTERISTICS (Devices listed in bold, italic are ON Semiconductor Preferred devices.)

Device	Device Marking	V_{RWM} (Note 6.) Volts	I_R @ V_{RWM} μA	Breakdown Voltage				V_C @ I_{PP} (Note 8.)		θ_{VBR} %/°C
				V_{BR} Volts (Note 7.)			@ I_T	V_C	I_{PP}	
				Min	Nom	Max	mA	Volts	Amps	
P6SMB6.8AT3	6V8A	5.8	1000	6.45	6.8	7.14	10	10.5	57	0.057
P6SMB7.5AT3	7V5A	6.4	500	7.13	7.51	7.88	10	11.3	53	0.061
P6SMB8.2AT3	8V2A	7.02	200	7.79	8.2	8.61	10	12.1	50	0.065
P6SMB9.1AT3	9V1A	7.78	50	8.65	9.1	9.55	1	13.4	45	0.068
P6SMB10AT3	10A	8.55	10	9.5	10	10.5	1	14.5	41	0.073
P6SMB11AT3	11A	9.4	5	10.5	11.05	11.6	1	15.6	38	0.075
P6SMB12AT3	12A	10.2	5	11.4	12	12.6	1	16.7	36	0.078
P6SMB13AT3	13A	11.1	5	12.4	13.05	13.7	1	18.2	33	0.081
P6SMB15AT3	15A	12.8	5	14.3	15.05	15.8	1	21.2	28	0.084
P6SMB16AT3	16A	13.6	5	15.2	16	16.8	1	22.5	27	0.086
P6SMB18AT3	18A	15.3	5	17.1	18	18.9	1	25.2	24	0.088
P6SMB20AT3	20A	17.1	5	19	20	21	1	27.7	22	0.09
P6SMB22AT3	22A	18.8	5	20.9	22	23.1	1	30.6	20	0.092
P6SMB24AT3	24A	20.5	5	22.8	24	25.2	1	33.2	18	0.094
P6SMB27AT3	27A	23.1	5	25.7	27.05	28.4	1	37.5	16	0.096
P6SMB30AT3	30A	25.6	5	28.5	30	31.5	1	41.4	14.4	0.097
P6SMB33AT3	33A	28.2	5	31.4	33.05	34.7	1	45.7	13.2	0.098
P6SMB36AT3	36A	30.8	5	34.2	36	37.8	1	49.9	12	0.099
P6SMB39AT3	39A	33.3	5	37.1	39.05	41	1	53.9	11.2	0.1
P6SMB43AT3	43A	36.8	5	40.9	43.05	45.2	1	59.3	10.1	0.101
P6SMB47AT3	47A	40.2	5	44.7	47.05	49.4	1	64.8	9.3	0.101
P6SMB51AT3	51A	43.6	5	48.5	51.05	53.6	1	70.1	8.6	0.102
P6SMB56AT3	56A	47.8	5	53.2	56	58.8	1	77	7.8	0.103
P6SMB62AT3	62A	53	5	58.9	62	65.1	1	85	7.1	0.104
P6SMB68AT3	68A	58.1	5	64.6	68	71.4	1	92	6.5	0.104
P6SMB75AT3	75A	64.1	5	71.3	75.05	78.8	1	103	5.8	0.105
P6SMB82AT3	82A	70.1	5	77.9	82	86.1	1	113	5.3	0.105
P6SMB91AT3	91A	77.8	5	86.5	91	95.5	1	125	4.8	0.106
P6SMB100AT3	100A	85.5	5	95	100	105	1	137	4.4	0.106
P6SMB110AT3	110A	94	5	105	110.5	116	1	152	4.0	0.107
P6SMB120AT3	120A	102	5	114	120	126	1	165	3.6	0.107
P6SMB130AT3	130A	111	5	124	130.5	137	1	179	3.3	0.107
P6SMB150AT3	150A	128	5	143	150.5	158	1	207	2.9	0.108
P6SMB160AT3	160A	136	5	152	160	168	1	219	2.7	0.108
P6SMB170AT3	170A	145	5	162	170	179	1	234	2.6	0.108
P6SMB180AT3	180A	154	5	171	180	189	1	246	2.4	0.108
P6SMB200AT3	200A	171	5	190	200	210	1	274	2.2	0.108

6. A transient suppressor is normally selected according to the working peak reverse voltage (V_{RWM}), which should be equal to or greater than the DC or continuous peak operating voltage level.
7. V_{BR} measured at pulse test current I_T at an ambient temperature of 25°C.
8. Surge current waveform per Figure 2 and derate per Figure 3.

P6SMB6.8AT3 Series

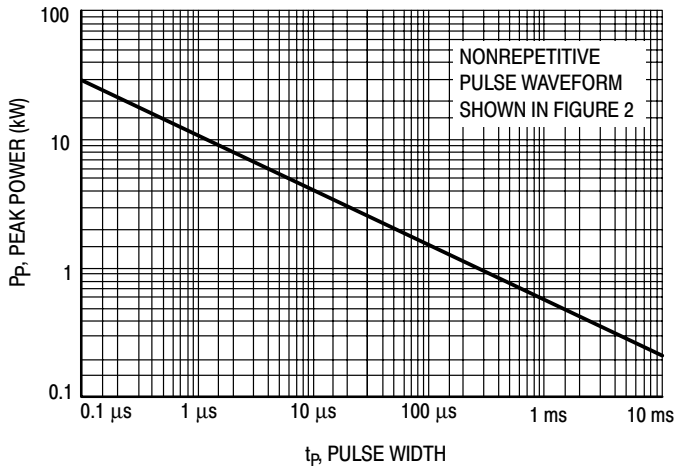

Figure 1. Pulse Rating Curve

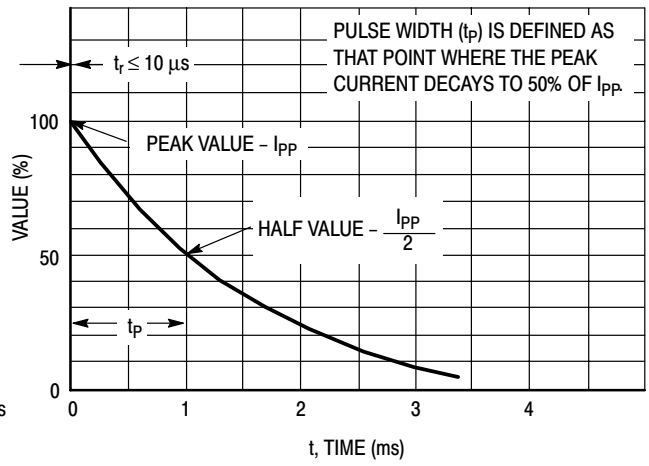

Figure 2. Pulse Waveform

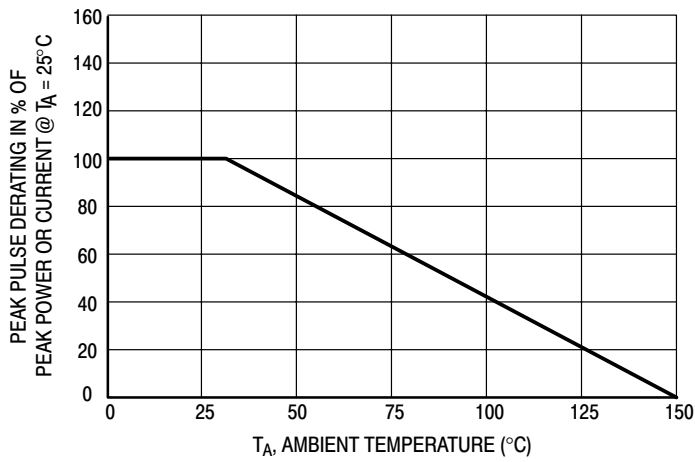

Figure 3. Pulse Derating Curve

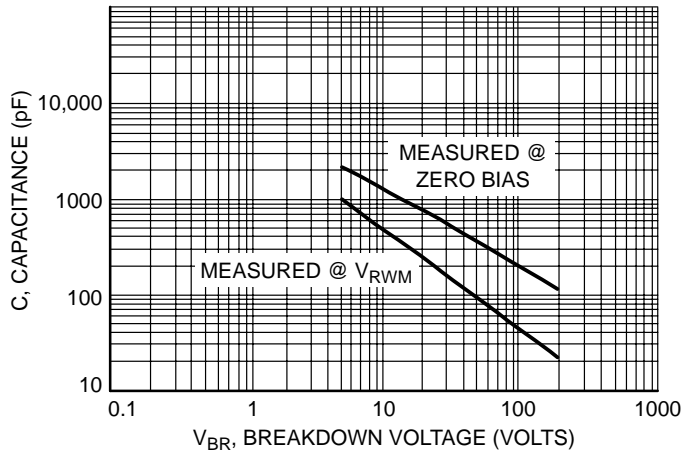
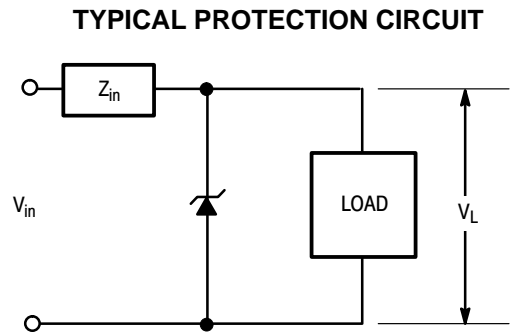

Figure 4. Capacitance versus Breakdown Voltage

P6SMB6.8AT3 Series

APPLICATION NOTES

RESPONSE TIME

In most applications, the transient suppressor device is placed in parallel with the equipment or component to be protected. In this situation, there is a time delay associated with the capacitance of the device and an overshoot condition associated with the inductance of the device and the inductance of the connection method. The capacitive effect is of minor importance in the parallel protection scheme because it only produces a time delay in the transition from the operating voltage to the clamp voltage as shown in Figure 5.

The inductive effects in the device are due to actual turn-on time (time required for the device to go from zero current to full current) and lead inductance. This inductive effect produces an overshoot in the voltage across the equipment or component being protected as shown in Figure 6. Minimizing this overshoot is very important in the application, since the main purpose for adding a transient suppressor is to clamp voltage spikes. The SMB series have a very good response time, typically < 1 ns and negligible inductance. However, external inductive effects could produce unacceptable overshoot. Proper circuit layout,

minimum lead lengths and placing the suppressor device as close as possible to the equipment or components to be protected will minimize this overshoot.

Some input impedance represented by Z_{in} is essential to prevent overstress of the protection device. This impedance should be as high as possible, without restricting the circuit operation.

DUTY CYCLE DERATING

The data of Figure 1 applies for non-repetitive conditions and at a lead temperature of 25°C. If the duty cycle increases, the peak power must be reduced as indicated by the curves of Figure 7. Average power must be derated as the lead or ambient temperature rises above 25°C. The average power derating curve normally given on data sheets may be normalized and used for this purpose.

At first glance the derating curves of Figure 7 appear to be in error as the 10 ms pulse has a higher derating factor than the 10 μ s pulse. However, when the derating factor for a given pulse of Figure 7 is multiplied by the peak power value of Figure 1 for the same pulse, the results follow the expected trend.

P6SMB6.8AT3 Series

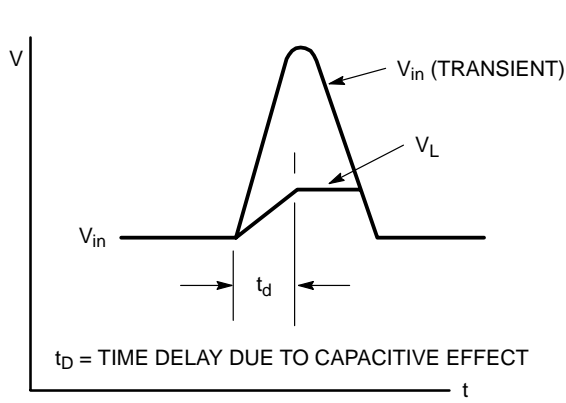

Figure 5.

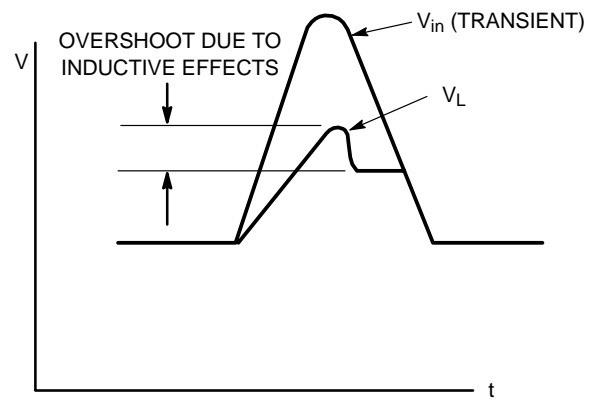

Figure 6.

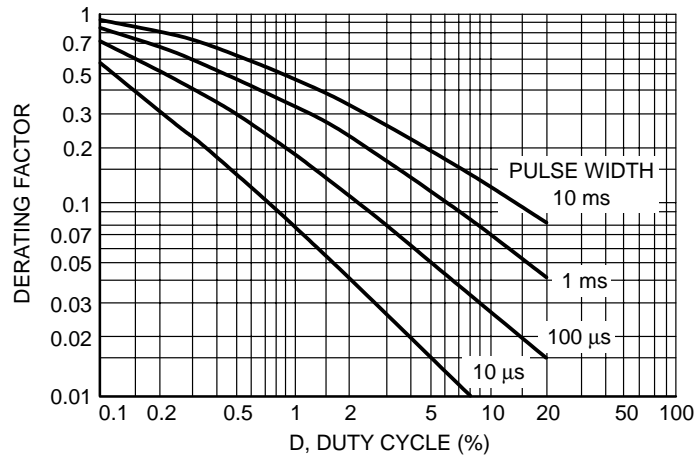

Figure 7. Typical Derating Factor for Duty Cycle

UL RECOGNITION

The entire series has *Underwriters Laboratory Recognition* for the classification of protectors (QVGV2) under the UL standard for safety 497B and File #116110. Many competitors only have one or two devices recognized or have recognition in a non-protective category. Some competitors have no recognition at all. With the UL497B recognition, our parts successfully passed several tests

including Strike Voltage Breakdown test, Endurance Conditioning, Temperature test, Dielectric Voltage-Withstand test, Discharge test and several more.

Whereas, some competitors have only passed a flammability test for the package material, we have been recognized for much more to be included in their Protector category.

P6SMB6.8AT3 Series

OUTLINE DIMENSIONS

Transient Voltage Suppressors – Surface Mounted

600 Watt Peak Power

SMB
DO-214AA
CASE 403A-03
ISSUE D

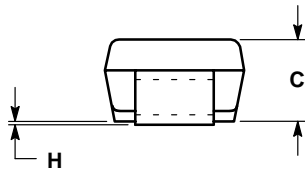
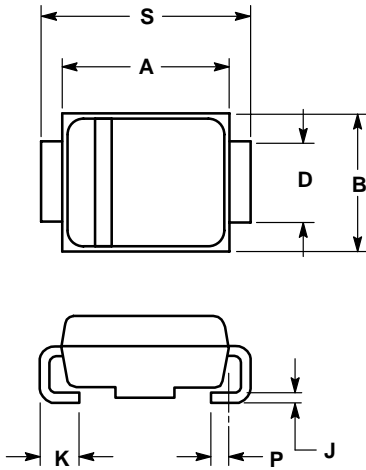

- NOTES:
1. DIMENSIONING AND TOLERANCING PER ANSI Y14.5M, 1982.
 2. CONTROLLING DIMENSION: INCH.
 3. D DIMENSION SHALL BE MEASURED WITHIN DIMENSION P.

DIM	INCHES		MILLIMETERS	
	MIN	MAX	MIN	MAX
A	0.160	0.180	4.06	4.57
B	0.130	0.150	3.30	3.81
C	0.075	0.095	1.90	2.41
D	0.077	0.083	1.96	2.11
H	0.0020	0.0060	0.051	0.152
J	0.006	0.012	0.15	0.30
K	0.030	0.050	0.76	1.27
P	0.020 REF		0.51 REF	
S	0.205	0.220	5.21	5.59

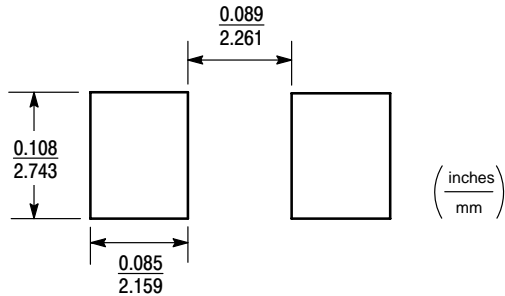

SMB Footprint

P6SMB6.8AT3 Series

Surmetic is a trademark of Semiconductor Components Industries, LLC.

ON Semiconductor and  are trademarks of Semiconductor Components Industries, LLC (SCILLC). SCILLC reserves the right to make changes without further notice to any products herein. SCILLC makes no warranty, representation or guarantee regarding the suitability of its products for any particular purpose, nor does SCILLC assume any liability arising out of the application or use of any product or circuit, and specifically disclaims any and all liability, including without limitation special, consequential or incidental damages. "Typical" parameters which may be provided in SCILLC data sheets and/or specifications can and do vary in different applications and actual performance may vary over time. All operating parameters, including "Typicals" must be validated for each customer application by customer's technical experts. SCILLC does not convey any license under its patent rights nor the rights of others. SCILLC products are not designed, intended, or authorized for use as components in systems intended for surgical implant into the body, or other applications intended to support or sustain life, or for any other application in which the failure of the SCILLC product could create a situation where personal injury or death may occur. Should Buyer purchase or use SCILLC products for any such unintended or unauthorized application, Buyer shall indemnify and hold SCILLC and its officers, employees, subsidiaries, affiliates, and distributors harmless against all claims, costs, damages, and expenses, and reasonable attorney fees arising out of, directly or indirectly, any claim of personal injury or death associated with such unintended or unauthorized use, even if such claim alleges that SCILLC was negligent regarding the design or manufacture of the part. SCILLC is an Equal Opportunity/Affirmative Action Employer.

PUBLICATION ORDERING INFORMATION

NORTH AMERICA Literature Fulfillment:

Literature Distribution Center for ON Semiconductor
P.O. Box 5163, Denver, Colorado 80217 USA
Phone: 303-675-2175 or 800-344-3860 Toll Free USA/Canada
Fax: 303-675-2176 or 800-344-3867 Toll Free USA/Canada
Email: ONlit@hibbertco.com
Fax Response Line: 303-675-2167 or 800-344-3810 Toll Free USA/Canada

N. American Technical Support: 800-282-9855 Toll Free USA/Canada

EUROPE: LDC for ON Semiconductor – European Support

German Phone: (+1) 303-308-7140 (Mon-Fri 2:30pm to 7:00pm CET)
Email: ONlit-german@hibbertco.com
French Phone: (+1) 303-308-7141 (Mon-Fri 2:00pm to 7:00pm CET)
Email: ONlit-french@hibbertco.com
English Phone: (+1) 303-308-7142 (Mon-Fri 12:00pm to 5:00pm GMT)
Email: ONlit@hibbertco.com

EUROPEAN TOLL-FREE ACCESS*: 00-800-4422-3781

*Available from Germany, France, Italy, UK, Ireland

CENTRAL/SOUTH AMERICA:

Spanish Phone: 303-308-7143 (Mon-Fri 8:00am to 5:00pm MST)
Email: ONlit-spanish@hibbertco.com
Toll-Free from Mexico: Dial 01-800-288-2872 for Access –
then Dial 866-297-9322

ASIA/PACIFIC: LDC for ON Semiconductor – Asia Support

Phone: 1-303-675-2121 (Tue-Fri 9:00am to 1:00pm, Hong Kong Time)
Toll Free from Hong Kong & Singapore:
001-800-4422-3781
Email: ONlit-asia@hibbertco.com

JAPAN: ON Semiconductor, Japan Customer Focus Center

4-32-1 Nishi-Gotanda, Shinagawa-ku, Tokyo, Japan 141-0031
Phone: 81-3-5740-2700
Email: r14525@onsemi.com

ON Semiconductor Website: <http://onsemi.com>

For additional information, please contact your local Sales Representative.