

# TIR1000, TIR1000I STANDALONE IrDA™ ENCODER AND DECODER

SLLS228F – DECEMBER 1995 – REVISED JULY 1999

- Adds Infrared (IR) Port to Universal Asynchronous Receiver Transmitter (UART)
- Compatible With Infrared Data Association (IrDA™) and Hewlett Packard Serial Infrared (HPSIR)
- Provides 1200 bps to 115 kbps Data Rate
- Operates From 2.7 V to 5.5 V
- Provides Simple Interface With UART
- Decodes Negative or Positive Pulses
- Available in Two 8-Terminal Plastic Small Outline Packages (PSOP), PS Package Has Slightly Larger Dimensions Than PW Package

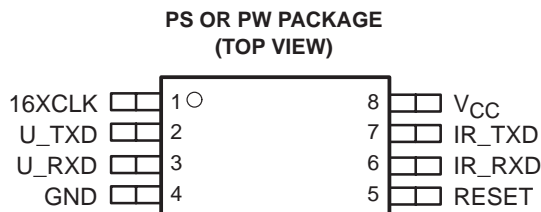

## functional block diagram

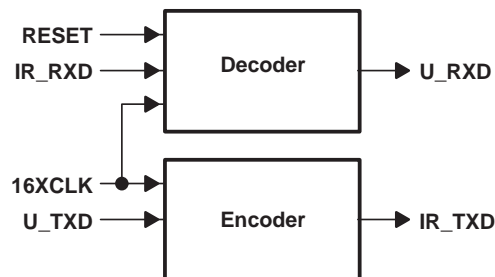

## description

The TIR1000 serial infrared (SIR) encoder/decoder is a CMOS device which encodes and decodes bit data in conformance with the IrDA specification.

A transceiver device is needed to interface to the photo-sensitive diode (PIN) and the light emitting diode (LED). A UART is needed to interface to the serial data lines.

## Terminal Functions

TERMINAL NAME	NO.	I/O	DESCRIPTION
16XCLK	1	I	Clock signal. 16XCLK should be set to 16 times the baud rate. The highest baud rate for IrDA is 115.2 kbps for which the clock frequency equals 1.843 MHz (this terminal is tied to the BAUDOUT of a UART).
GND	4		Ground
IR_RXD	6	I	Infrared receiver data. IR_RXD is an IrDA-SIR-modulated input from an optoelectronics transceiver whose input pulses should be 3/16 of the baud rate period.
IR_TXD	7	O	Infrared transmitter data. IR_TXD is an IrDA-SIR-modulated output to an optoelectronics transceiver.
RESET	5	I	Active high reset. RESET initializes an IrDA-SIR-decode/encode state machine (this terminal is tied to a UART reset line).
U_RXD	3	O	Receiver data. U_RXD is decoded (demodulated) data from IR_RXD according to the IrDA specification (this terminal is tied to SIN of a UART).
U_TXD	2	I	Transmitter data. U_TXD is encoded (modulated) data and output data as IR_TXD (this terminal is tied to SOUT from a UART).
VCC	8		Supply voltage



Please be aware that an important notice concerning availability, standard warranty, and use in critical applications of Texas Instruments semiconductor products and disclaimers thereto appears at the end of this data sheet.

IrDA is a registered trademark of the Infrared Data Association.

PRODUCTION DATA information is current as of publication date. Products conform to specifications per the terms of Texas Instruments standard warranty. Production processing does not necessarily include testing of all parameters.

**TEXAS  
INSTRUMENTS**

POST OFFICE BOX 655303 • DALLAS, TEXAS 75265

Copyright © 1999, Texas Instruments Incorporated

# TIR1000, TIR1000I STANDALONE IrDA™ ENCODER AND DECODER

SLLS228F – DECEMBER 1995 – REVISED JULY 1999

## absolute maximum ratings over operating free-air temperature range (unless otherwise noted)†

Supply voltage range, $V_{CC}$ (see Note 1)	–0.5 V to 6 V
Input voltage range at any input, $V_I$	–0.5 V to $V_{CC} + 0.5$ V
Output voltage range, $V_O$	–0.5 V to $V_{CC} + 0.5$ V
Operating free-air temperature range, $T_A$ , TIR1000	0°C to 70°C
$T_A$ , TIR1000I	–40°C to 85°C
Storage temperature range, $T_{stg}$	–65°C to 150°C
Case temperature for 10 seconds: SOP package	260°C

† Stresses beyond those listed under “absolute maximum ratings” may cause permanent damage to the device. These are stress ratings only, and functional operation of the device at these or any other conditions beyond those indicated under “recommended operating conditions” is not implied. Exposure to absolute-maximum-rated conditions for extended periods may affect device reliability.

NOTE 1: All voltage levels are with respect to GND.

## recommended operating conditions over recommended operating free-air temperature range

### low voltage (3 V nominal)

		MIN	NOM	MAX	UNIT
Supply voltage, $V_{CC}$		2.7	3	3.3	V
High-level input voltage, $V_{IH}$		0.7 $V_{CC}$			V
Low-level input voltage, $V_{IL}$		0.2 $V_{CC}$			V
Operating free-air temperature, $T_A$	TIR1000	0		70	°C
	TIR1000I	–40		85	

### standard voltage (5 V nominal)

		MIN	NOM	MAX	UNIT
Supply voltage, $V_{CC}$		4.5	5	5.5	V
High-level input voltage, $V_{IH}$		0.7 $V_{CC}$			V
Low-level input voltage, $V_{IL}$		0.2 $V_{CC}$			V
Operating free-air temperature, $T_A$	TIR1000	0		70	°C
	TIR1000I	–40		85	

## electrical characteristics over recommended operating free-air temperature range (unless otherwise noted)

PARAMETER	TEST CONDITIONS	MIN	TYP	MAX	UNIT
$V_{OH}$ High-level output voltage	$I_{OH} = -4$ mA $V_{CC} = 5$ V	$V_{CC} - 0.8$			V
	$I_{OH} = -1.8$ mA $V_{CC} = 3$ V	$V_{CC} - 0.55$			
$V_{OL}$ Low-level output voltage	$I_{OL} = +4$ mA $V_{CC} = 5$ V	0.5			V
	$I_{OL} = +1.8$ mA $V_{CC} = 3$ V	0.5			
$I_I$ Input current	$V_I = 0$ to $V_{CC}$ , All other pins floating	±3			µA
$I_{CC}$ Supply current	$V_{CC} = 5.25$ V, $T_A = 25^\circ\text{C}$ , All inputs at 0.2 V, 16XCLK at 2 MHz, No load on outputs	1			mA
$C_i(16XCLK)$ Clock input capacitance		5			pF
$f(16XCLK)$ Clock frequency		2			MHz



### switching characteristics

PARAMETER		TEST CONDITIONS	MIN	TYP†	MAX	UNIT
$t_r$	Output rise time	$C_{(LOAD)} = 15 \text{ pF}$ (10% to 90%)		1.3		ns
$t_f$	Output fall time	$C_{(LOAD)} = 15 \text{ pF}$ (90% to 10%)		1.8		ns

† Typical values are at  $T_A = 25^\circ\text{C}$ .

### APPLICATION INFORMATION

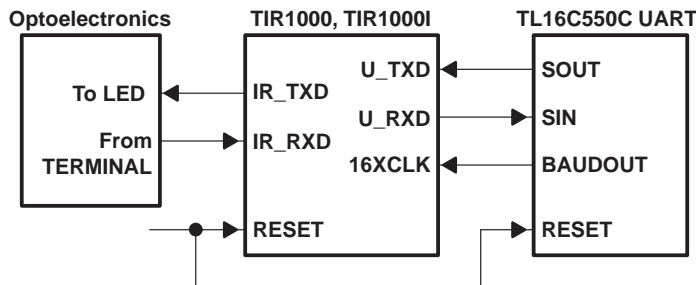

Figure 1. Typical application of the TIR1000, TIR1000I

### PRINCIPLES OF OPERATION

#### IrDA overview

The Infrared Data Association (IrDA) defines several protocols for sending and receiving serial infrared data, including rates of 115.2 kbps, 0.576 Mbps, 1.152 Mbps, and 4 Mbps. The low rate of 115.2 kbps was specified first and the others must maintain downward compatibility with it. At the 115.2 kbps rate, the protocol implemented in the hardware is fairly simple. It primarily defines a serial infrared data *word* to be surrounded by a start bit equal to 0 and a stop bit equal to 1. Individual bits are encoded or decoded the same whether they are start, data, or stop bits. The TIR1000 and TIR1000I evaluate only single bits and only follow the 115.2 kbps protocol. The 115.2 kbps rate is a maximum rate. When both ends of the transfer are set up to a lower but matching speed, the protocol (with the TIR1000 and TIR1000I) still works. The clock used to code or sample the data is 16 times the baud rate, or 1.843 Mhz maximum. To code a 1, no pulse is sent or received for 1-bit time period, or 16 clock cycles. To code a 0, one pulse is sent or received within a 1-bit time period, or 16 clock cycles. The pulse must be at least 1.6  $\mu\text{s}$  wide and 3 clock cycles long at 1.843 Mhz. At lower baud rates the pulse can be 1.6  $\mu\text{s}$  wide or as long as 3 clock cycles. The transmitter output, IR\_TXD, is intended to drive a LED circuit to generate an infrared pulse. The LED circuits work on positive pulses. A terminal circuit is expected to create the receiver input, IR\_RXD. Most, but not all, PIN circuits have inversion and generate negative pulses from the detected infrared light. Their output is normally high. The TIR1000 and TIR1000I can decode either negative or positive pulses on IR\_RXD.

# TIR1000, TIR1000I STANDALONE IrDA™ ENCODER AND DECODER

SLLS228F – DECEMBER 1995 – REVISED JULY 1999

## PRINCIPLES OF OPERATION

### IrDA encoder function

Serial data from a UART is encoded to transmit data to the optoelectronics. While the serial data input to this block (U\_TXD) is high, the output (IR\_TXD) is always low, and the counter used to form a pulse on IR\_TXD is continuously cleared. After U\_TXD resets to 0, IR\_TXD rises on the falling edge of the seventh 16XCLK. On the falling edge of the tenth 16XCLK pulse, IR\_TXD falls, creating a 3-clock-wide pulse. While U\_TXD stays low, a pulse is transmitted during the seventh to tenth clocks of each 16-clock bit cycle.

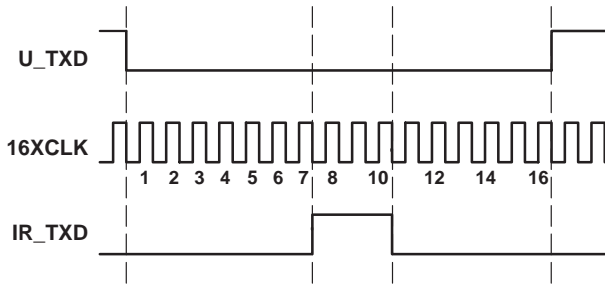

Figure 2. IrDA-SIR Encoding Scheme – Detailed Timing Diagram

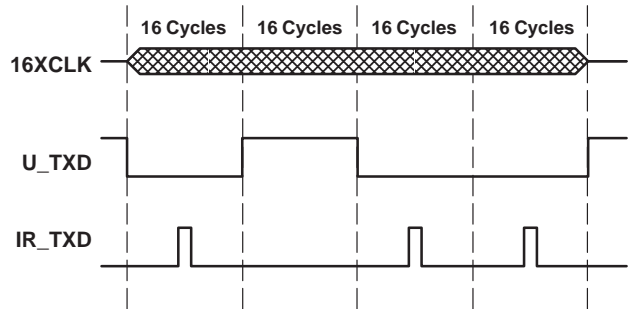

Figure 3. Encoding Scheme – Macro View

### IrDA decoder function

After reset, U\_RXD is high and the 4-bit counter is cleared. When a falling edge is detected on IR\_RXD, U\_RXD falls on the next rising edge of 16XCLK with sufficient setup time. U\_RXD stays low for 16 cycles (16XCLK) and then returns to high as required by the IrDA specification. As long as no pulses (falling edges) are detected on IR\_RXD, U\_RXD remains high.

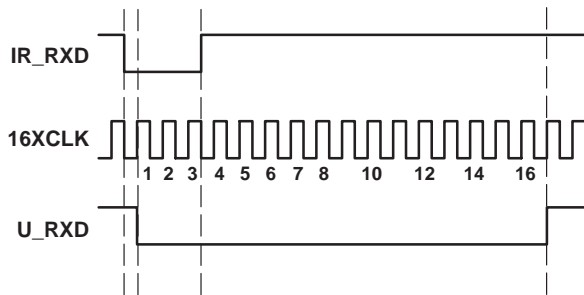

Figure 4. IrDA-SIR Decoding Scheme – Detailed Timing Diagram

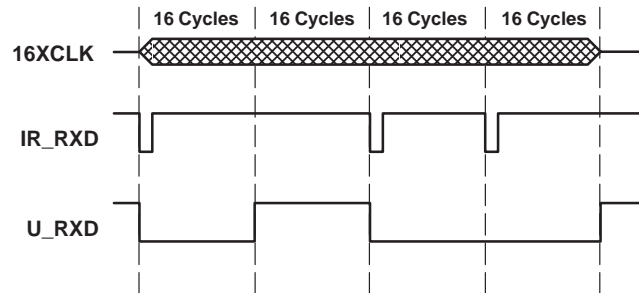

Figure 5. Decoding Scheme – Macro View

PRINCIPLES OF OPERATION

IrDA encoder function (continued)

It is possible for jitter or slight frequency differences to cause the next falling edge on IR\_RXD to be missed for one 16XCLK cycle. In that case, a 1-clock-wide pulse appears on U\_RXD between consecutive zeroes. It is important for the UART to strobe U\_RXD in the middle of the bit time to avoid latching this 1-clock-wide pulse. The TL16C550C UART already strobes incoming serial data at the proper time. Otherwise, note that data is required to be framed by a leading zero and a trailing one. The falling edge of that first zero on U\_RXD synchronizes the read strobe. The strobe occurs on the eighth 16XCLK pulse after the U\_RXD falling edge and once every 16 cycles thereafter until the stop bit occurs.

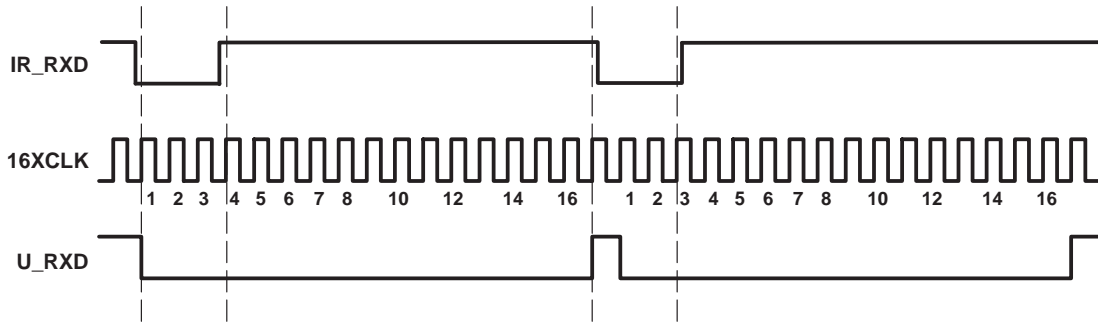

Figure 6. Timing Causing 1-clock-wide Pulse Between Consecutive Ones

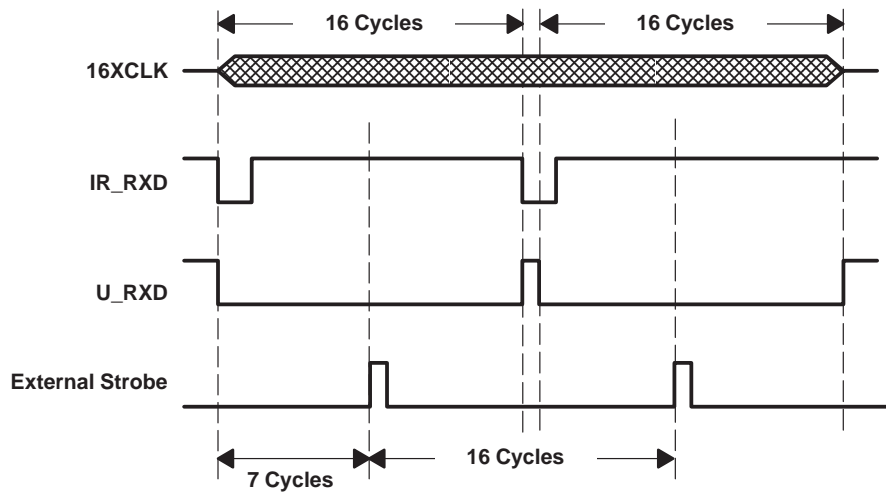

Figure 7. Recommended Strobing For Decoded Data

# TIR1000, TIR1000I STANDALONE IrDA™ ENCODER AND DECODER

SLLS228F – DECEMBER 1995 – REVISED JULY 1999

## PRINCIPLES OF OPERATION

### IrDA encoder function (continued)

The TIR1000 and TIR1000I can decode positive pulses on IR\_RXD. The timing is different, but the variation is invisible to the UART. The decoder, which works from the falling edge, now recognizes a zero on the trailing edge of the pulse rather than on the leading edge. As long as the pulse width is fairly constant, as defined by the specification, the trailing edges should also be 16 clock cycles apart and data can readily be decoded. The zero appears on U\_RXD after the pulse rather than at the start of it.

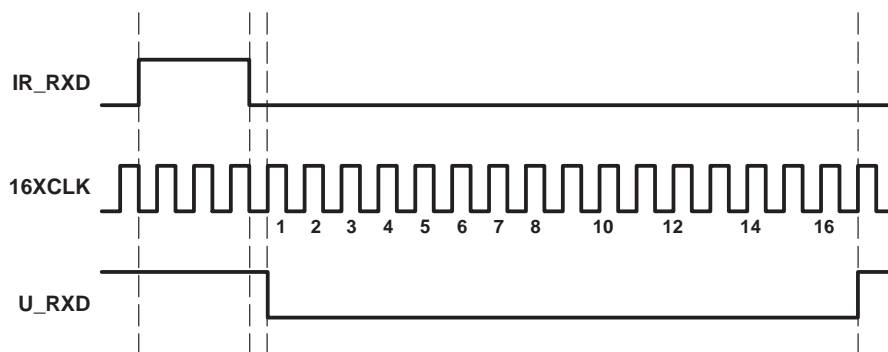

Figure 8. Positive IR\_RXD Pulse Decode – Detailed View

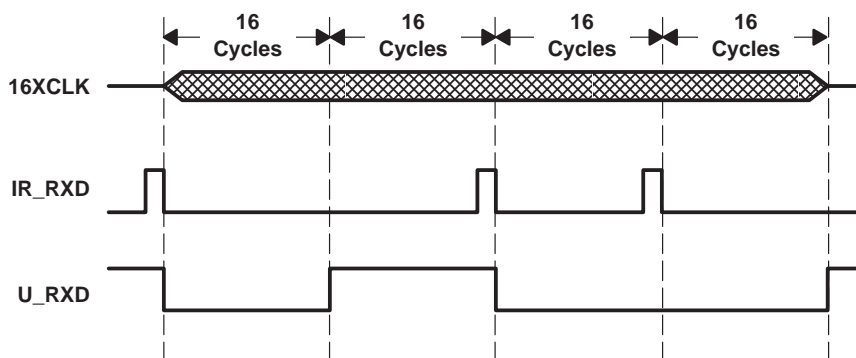
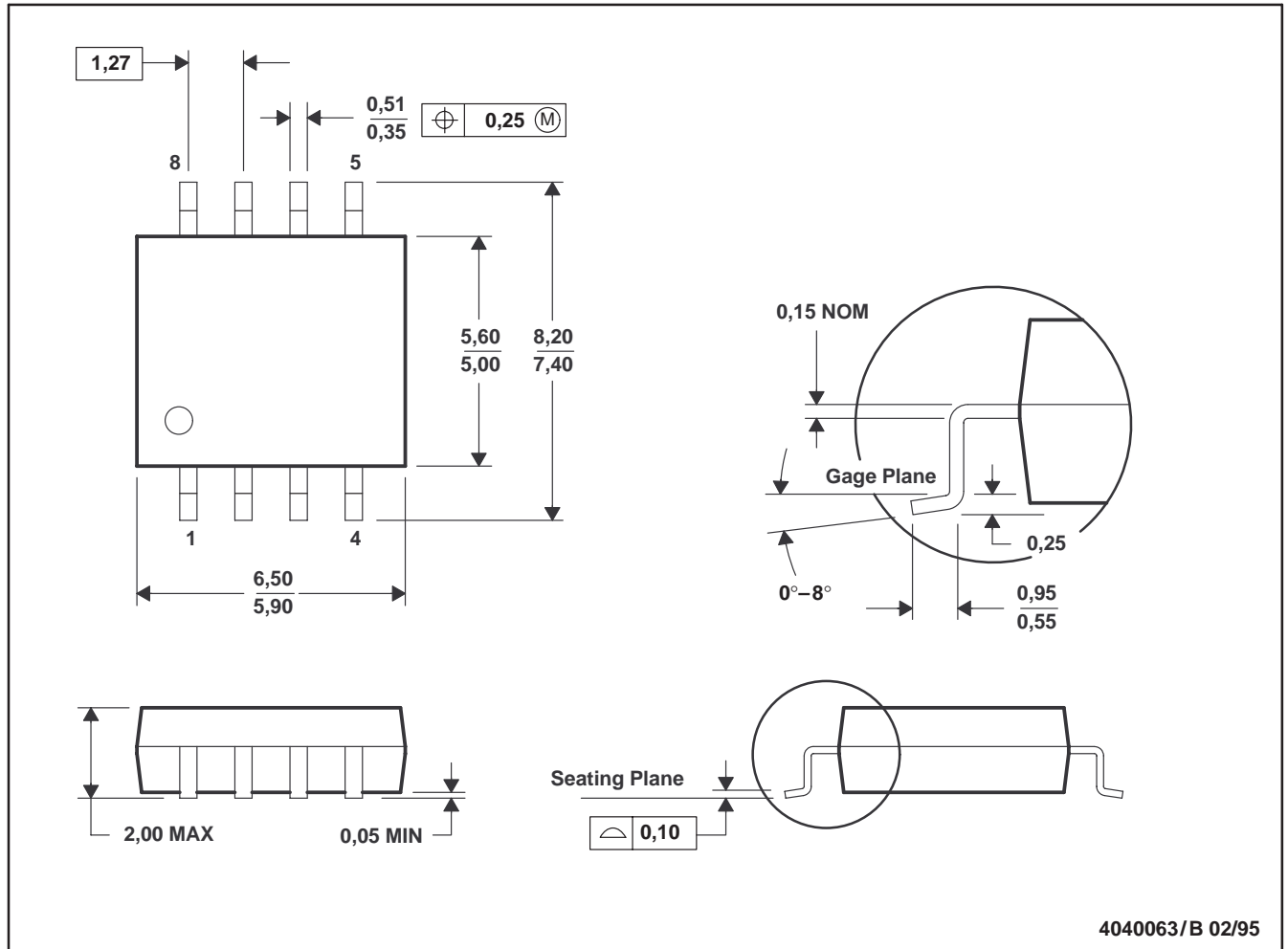

Figure 9. Positive IR\_RXD Pulse Decode – Macro View

MECHANICAL DATA

PS (R-PDSO-G8)

PLASTIC SMALL-OUTLINE PACKAGE



- NOTES: A. All linear dimensions are in millimeters.  
 B. This drawing is subject to change without notice.  
 C. Body dimensions do not include mold flash or protrusion, not to exceed 0,15.

# TIR1000, TIR1000I STANDALONE IrDA™ ENCODER AND DECODER

SLLS228F – DECEMBER 1995 – REVISED JULY 1999

## MECHANICAL DATA

PW (R-PDSO-G\*\*)

PLASTIC SMALL-OUTLINE PACKAGE

14 TERMINAL SHOWN

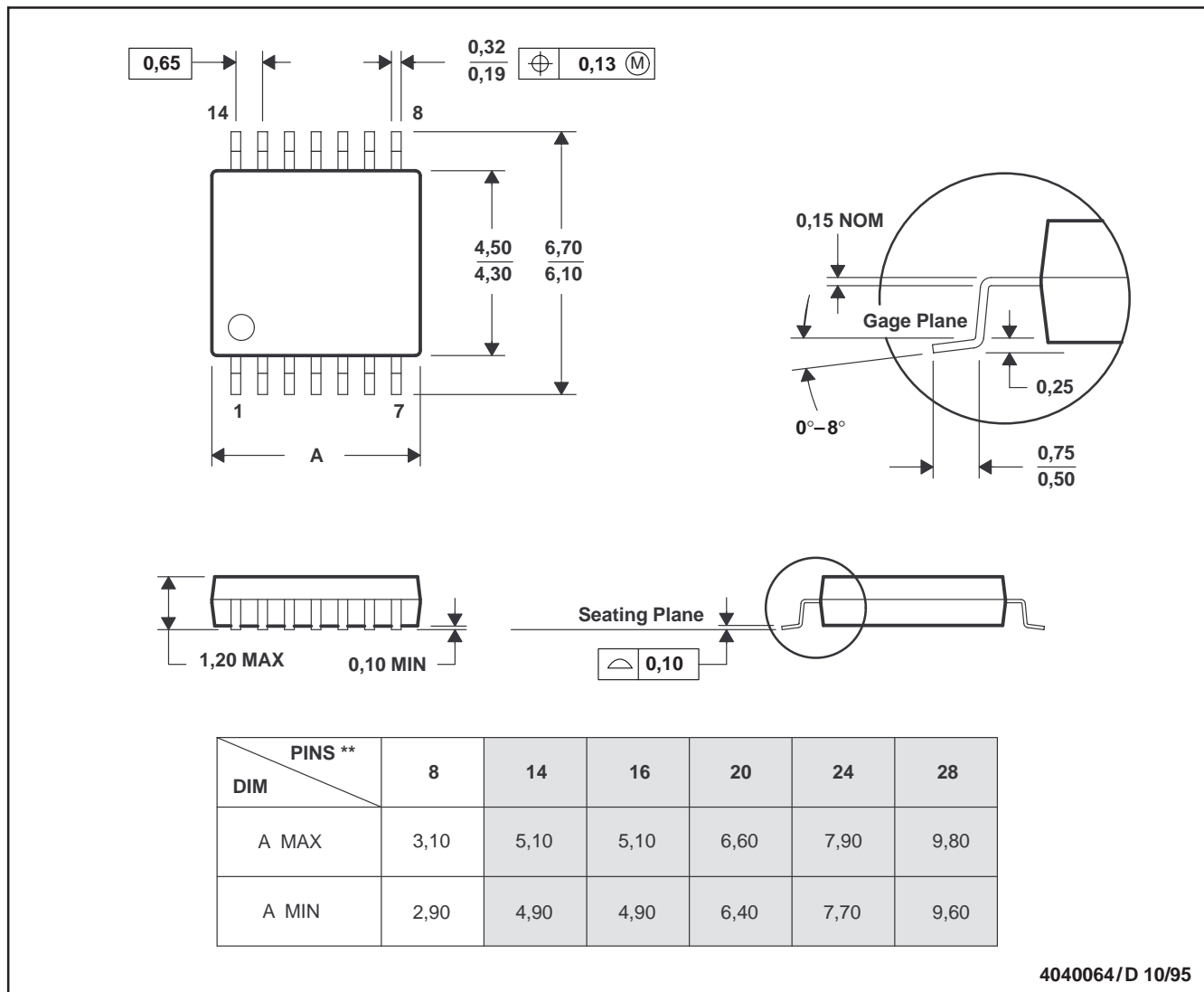

- NOTES: A. All linear dimensions are in millimeters.  
 B. This drawing is subject to change without notice.  
 C. Body dimensions do not include mold flash or protrusion not to exceed 0,15.  
 D. Falls within JEDEC MO-153



## IMPORTANT NOTICE

Texas Instruments and its subsidiaries (TI) reserve the right to make changes to their products or to discontinue any product or service without notice, and advise customers to obtain the latest version of relevant information to verify, before placing orders, that information being relied on is current and complete. All products are sold subject to the terms and conditions of sale supplied at the time of order acknowledgement, including those pertaining to warranty, patent infringement, and limitation of liability.

TI warrants performance of its semiconductor products to the specifications applicable at the time of sale in accordance with TI's standard warranty. Testing and other quality control techniques are utilized to the extent TI deems necessary to support this warranty. Specific testing of all parameters of each device is not necessarily performed, except those mandated by government requirements.

CERTAIN APPLICATIONS USING SEMICONDUCTOR PRODUCTS MAY INVOLVE POTENTIAL RISKS OF DEATH, PERSONAL INJURY, OR SEVERE PROPERTY OR ENVIRONMENTAL DAMAGE ("CRITICAL APPLICATIONS"). TI SEMICONDUCTOR PRODUCTS ARE NOT DESIGNED, AUTHORIZED, OR WARRANTED TO BE SUITABLE FOR USE IN LIFE-SUPPORT DEVICES OR SYSTEMS OR OTHER CRITICAL APPLICATIONS. INCLUSION OF TI PRODUCTS IN SUCH APPLICATIONS IS UNDERSTOOD TO BE FULLY AT THE CUSTOMER'S RISK.

In order to minimize risks associated with the customer's applications, adequate design and operating safeguards must be provided by the customer to minimize inherent or procedural hazards.

TI assumes no liability for applications assistance or customer product design. TI does not warrant or represent that any license, either express or implied, is granted under any patent right, copyright, mask work right, or other intellectual property right of TI covering or relating to any combination, machine, or process in which such semiconductor products or services might be or are used. TI's publication of information regarding any third party's products or services does not constitute TI's approval, warranty or endorsement thereof.