

To all our customers

Regarding the change of names mentioned in the document, such as Hitachi Electric and Hitachi XX, to Renesas Technology Corp.

The semiconductor operations of Mitsubishi Electric and Hitachi were transferred to Renesas Technology Corporation on April 1st 2003. These operations include microcomputer, logic, analog and discrete devices, and memory chips other than DRAMs (flash memory, SRAMs etc.) Accordingly, although Hitachi, Hitachi, Ltd., Hitachi Semiconductors, and other Hitachi brand names are mentioned in the document, these names have in fact all been changed to Renesas Technology Corp. Thank you for your understanding. Except for our corporate trademark, logo and corporate statement, no changes whatsoever have been made to the contents of the document, and these changes do not constitute any alteration to the contents of the document itself.

Renesas Technology Home Page: <http://www.renesas.com>

Renesas Technology Corp.
Customer Support Dept.
April 1, 2003

Cautions

Keep safety first in your circuit designs!

1. Renesas Technology Corporation puts the maximum effort into making semiconductor products better and more reliable, but there is always the possibility that trouble may occur with them. Trouble with semiconductors may lead to personal injury, fire or property damage.

Remember to give due consideration to safety when making your circuit designs, with appropriate measures such as (i) placement of substitutive, auxiliary circuits, (ii) use of nonflammable material or (iii) prevention against any malfunction or mishap.

Notes regarding these materials

1. These materials are intended as a reference to assist our customers in the selection of the Renesas Technology Corporation product best suited to the customer's application; they do not convey any license under any intellectual property rights, or any other rights, belonging to Renesas Technology Corporation or a third party.
2. Renesas Technology Corporation assumes no responsibility for any damage, or infringement of any third-party's rights, originating in the use of any product data, diagrams, charts, programs, algorithms, or circuit application examples contained in these materials.
3. All information contained in these materials, including product data, diagrams, charts, programs and algorithms represents information on products at the time of publication of these materials, and are subject to change by Renesas Technology Corporation without notice due to product improvements or other reasons. It is therefore recommended that customers contact Renesas Technology Corporation or an authorized Renesas Technology Corporation product distributor for the latest product information before purchasing a product listed herein.
The information described here may contain technical inaccuracies or typographical errors. Renesas Technology Corporation assumes no responsibility for any damage, liability, or other loss rising from these inaccuracies or errors.
Please also pay attention to information published by Renesas Technology Corporation by various means, including the Renesas Technology Corporation Semiconductor home page (<http://www.renesas.com>).
4. When using any or all of the information contained in these materials, including product data, diagrams, charts, programs, and algorithms, please be sure to evaluate all information as a total system before making a final decision on the applicability of the information and products. Renesas Technology Corporation assumes no responsibility for any damage, liability or other loss resulting from the information contained herein.
5. Renesas Technology Corporation semiconductors are not designed or manufactured for use in a device or system that is used under circumstances in which human life is potentially at stake. Please contact Renesas Technology Corporation or an authorized Renesas Technology Corporation product distributor when considering the use of a product contained herein for any specific purposes, such as apparatus or systems for transportation, vehicular, medical, aerospace, nuclear, or undersea repeater use.
6. The prior written approval of Renesas Technology Corporation is necessary to reprint or reproduce in whole or in part these materials.
7. If these products or technologies are subject to the Japanese export control restrictions, they must be exported under a license from the Japanese government and cannot be imported into a country other than the approved destination.
Any diversion or reexport contrary to the export control laws and regulations of Japan and/or the country of destination is prohibited.
8. Please contact Renesas Technology Corporation for further details on these materials or the products contained therein.

HM62V16256C Series

4 M SRAM (256-kword × 16-bit)



ADE-203-1099G (Z)

Rev. 4.0

Jul. 31, 2002

Description

The Hitachi HM62V16256C Series is 4-Mbit static RAM organized 262,144-word × 16-bit. HM62V16256C Series has realized higher density, higher performance and low power consumption by employing CMOS process technology (6-transistor memory cell). It offers low power standby power dissipation; therefore, it is suitable for battery backup systems. It is packaged in standard 44-pin plastic TSOPII.

Features

- Single 2.5 V and 3.0 V supply: 2.2 V to 3.6 V
- Fast access time: 55 ns (max)
- Power dissipation:
 - Active: 5.0 mW/MHz (typ)($V_{CC} = 2.5$ V)
: 6.0 mW/MHz (typ) ($V_{CC} = 3.0$ V)
 - Standby: 2 μ W (typ) ($V_{CC} = 2.5$ V)
: 2.4 μ W (typ) ($V_{CC} = 3.0$ V)
- Completely static memory.
 - No clock or timing strobe required
- Equal access and cycle times
- Common data input and output.
 - Three state output
- Battery backup operation.
 - 2 chip selection for battery backup

HM62V16256C Series

Ordering Information

Type No.	Access time	Package
HM62V16256CLTT-5	55 ns	400-mil 44-pin plastic TSOPII (normal-bend type) (TTP-44DB)
HM62V16256CLTT-5SL	55 ns	

Pin Arrangement

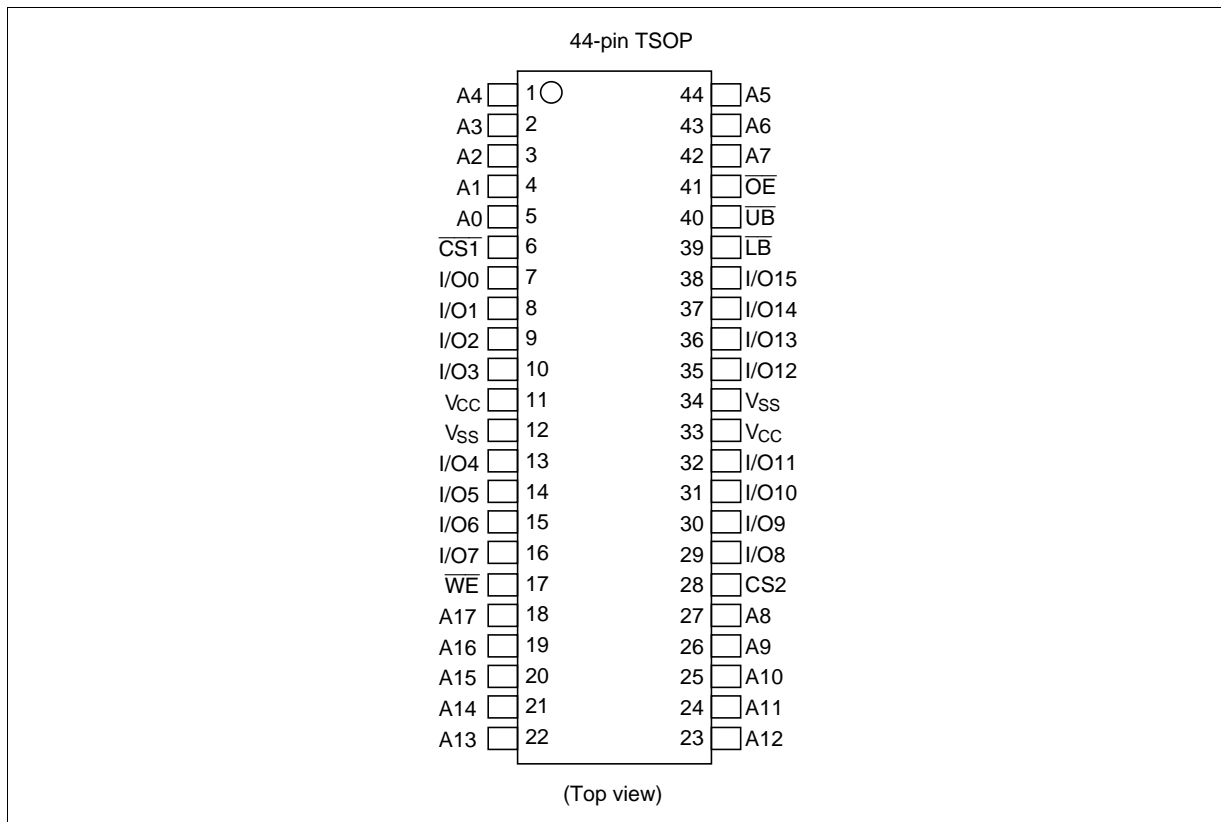

Pin Description

Pin name	Function
A0 to A17	Address input
I/O0 to I/O15	Data input/output
$\overline{CS1}$	Chip select 1
$\overline{CS2}$	Chip select 2
\overline{WE}	Write enable
\overline{OE}	Output enable
\overline{LB}	Lower byte select
\overline{UB}	Upper byte select
V_{CC}	Power supply
V_{SS}	Ground

Block Diagram

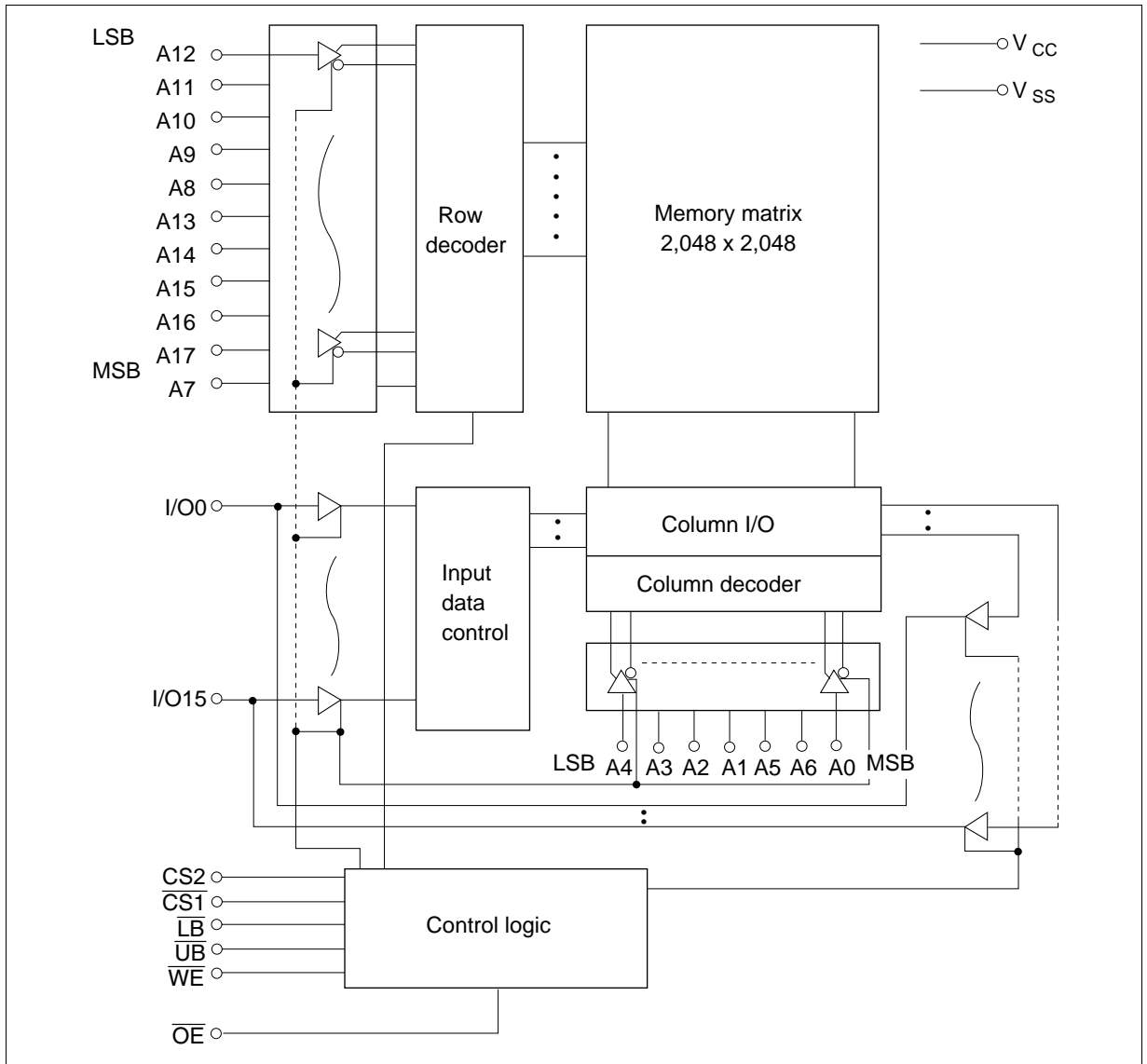

Operation Table

CS1	CS2	WE	OE	UB	LB	I/O0 to I/O7	I/O8 to I/O15	Operation
H	×	×	×	×	×	High-Z	High-Z	Standby
×	L	×	×	×	×	High-Z	High-Z	Standby
×	×	×	×	H	H	High-Z	High-Z	Standby
L	H	H	L	L	L	Dout	Dout	Read
L	H	H	L	H	L	Dout	High-Z	Lower byte read
L	H	H	L	L	H	High-Z	Dout	Upper byte read
L	H	L	×	L	L	Din	Din	Write
L	H	L	×	H	L	Din	High-Z	Lower byte write
L	H	L	×	L	H	High-Z	Din	Upper byte write
L	H	H	H	×	×	High-Z	High-Z	Output disable

Note: H: V_{IH} , L: V_{IL} , ×: V_{IH} or V_{IL}

Absolute Maximum Ratings

Parameter	Symbol	Value	Unit
Power supply voltage relative to V_{SS}	V_{CC}	-0.5 to +4.6	V
Terminal voltage on any pin relative to V_{SS}	V_T	-0.5 ^{*1} to $V_{CC} + 0.3$ ^{*2}	V
Power dissipation	P_T	1.0	W
Storage temperature range	Tstg	-55 to +125	°C
Storage temperature range under bias	Tbias	-20 to +85	°C

Notes: 1. V_T min: -3.0 V for pulse half-width \leq 30 ns.
2. Maximum voltage is +4.6 V.

DC Operating Conditions

Parameter	Symbol	Min	Typ	Max	Unit	Note	
Supply voltage	V_{CC}	2.2	2.5/3.0	3.6	V		
	V_{SS}	0	0	0	V		
Input high voltage	$V_{CC} = 2.2$ V to 2.7 V	V_{IH}	2.0	—	$V_{CC} + 0.3$	V	
	$V_{CC} = 2.7$ V to 3.6 V	V_{IH}	2.0	—	$V_{CC} + 0.3$	V	
Input low voltage	$V_{CC} = 2.2$ V to 2.7 V	V_{IL}	-0.2	—	0.4	V	1
	$V_{CC} = 2.7$ V to 3.6 V	V_{IL}	-0.3	—	0.6	V	1
Ambient temperature range	Ta	-20	—	70	°C		

Note: 1. V_{IL} min: -3.0 V for pulse half-width \leq 30 ns.

DC Characteristics

Parameter	Symbol	Min	Typ* ¹	Max	Unit	Test conditions
Input leakage current	$ I_{LI} $	—	—	1	μA	$V_{in} = V_{SS}$ to V_{CC}
Output leakage current	$ I_{LO} $	—	—	1	μA	$\overline{CS1} = V_{IH}$ or $CS2 = V_{IL}$ or $\overline{OE} = V_{IH}$ or $\overline{WE} = V_{IL}$ or $\overline{LB} = \overline{UB} = V_{IH}$, $V_{IO} = V_{SS}$ to V_{CC}
Operating current	I_{CC}	—	5	20	mA	$\overline{CS1} = V_{IL}$, $CS2 = V_{IH}$, Others = V_{IH}/V_{IL} , $I_{IO} = 0 \text{ mA}$
Average operating current	I_{CC1}	—	8	25	mA	Min. cycle, duty = 100%, $I_{IO} = 0 \text{ mA}$, $\overline{CS1} = V_{IL}$, $CS2 = V_{IH}$, Others = V_{IH}/V_{IL}
	I_{CC2}	—	2	5	mA	Cycle time = 1 μs , duty = 100%, $I_{IO} = 0 \text{ mA}$, $\overline{CS1} \leq 0.2 \text{ V}$, $CS2 \geq V_{CC} - 0.2 \text{ V}$ $V_{IH} \geq V_{CC} - 0.2 \text{ V}$, $V_{IL} \leq 0.2 \text{ V}$
Standby current	I_{SB}	—	0.1	0.3	mA	$CS2 = V_{IL}$
Standby current	I_{SB1}^{*2}	—	0.5	20	μA	$0 \text{ V} \leq V_{in}$ (1) $0 \text{ V} \leq CS2 \leq 0.2 \text{ V}$ or (2) $\overline{CS1} \geq V_{CC} - 0.2 \text{ V}$, $CS2 \geq V_{CC} - 0.2 \text{ V}$ or (3) $\overline{LB} = \overline{UB} \geq V_{CC} - 0.2 \text{ V}$ $CS2 \geq V_{CC} - 0.2 \text{ V}$ $\overline{CS1} \leq 0.2 \text{ V}$
	I_{SB1}^{*3}	—	0.5	10	μA	
Output high voltage	$V_{CC} = 2.2 \text{ V}$ to 2.7 V	V_{OH}	2.0	—	V	$I_{OH} = -0.5 \text{ mA}$
	$V_{CC} = 2.7 \text{ V}$ to 3.6 V	V_{OH}	2.4	—	V	$I_{OH} = -1 \text{ mA}$
	$V_{CC} = 2.2 \text{ V}$ to 3.6 V	V_{OH}	$V_{CC} - 0.2$	—	V	$I_{OH} = -100 \mu\text{A}$
Output low voltage	$V_{CC} = 2.2 \text{ V}$ to 2.7 V	V_{OL}	—	0.4	V	$I_{OL} = 0.5 \text{ mA}$
	$V_{CC} = 2.7 \text{ V}$ to 3.6 V	V_{OL}	—	0.4	V	$I_{OL} = 2 \text{ mA}$
	$V_{CC} = 2.2 \text{ V}$ to 3.6 V	V_{OL}	—	0.2	V	$I_{OL} = 100 \mu\text{A}$

Notes: 1. Typical values are at $V_{CC} = 2.5 \text{ V}/3.0 \text{ V}$, $T_a = +25^\circ\text{C}$ and not guaranteed.

2. This characteristic is guaranteed only for L-version.

3. This characteristic is guaranteed only for L-SL version.

Capacitance ($T_a = +25^\circ\text{C}$, $f = 1.0\text{ MHz}$)

Parameter	Symbol	Min	Typ	Max	Unit	Test conditions	Note
Input capacitance	C_{in}	—	—	8	pF	$V_{in} = 0\text{ V}$	1
Input/output capacitance	$C_{i/o}$	—	—	10	pF	$V_{i/o} = 0\text{ V}$	1

Note: 1. This parameter is sampled and not 100% tested.

AC Characteristics (Ta = -20 to +70°C, V_{CC} = 2.2 V to 3.6 V, unless otherwise noted.)

Test Conditions

- Input pulse levels: V_{IL} = 0.4 V, V_{IH} = 2.0 V (V_{CC} = 2.2 V to 2.7 V)
V_{IL} = 0.4 V, V_{IH} = 2.2 V (V_{CC} = 2.7 V to 3.6 V)
- Input rise and fall time: 5 ns
- Input timing reference levels: 1.1 V (V_{CC} = 2.2 V to 2.7 V)
- Output timing reference levels: 1.1 V (V_{CC} = 2.2 V to 2.7 V)
- Input timing reference levels: 1.4 V (V_{CC} = 2.7 V to 3.6 V)
- Output timing reference levels: 1.4 V (V_{CC} = 2.7 V to 3.6 V)
- Output load: See figures (Including scope and jig)

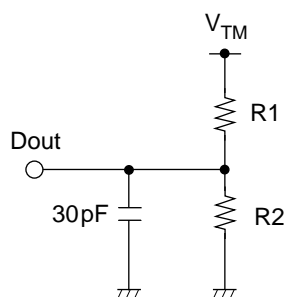

R1 = 3070 Ω
R2 = 3150 Ω
V_{TM} = 2.3 V

Output load (A)
(V_{CC} = 2.2 V to 2.7 V)

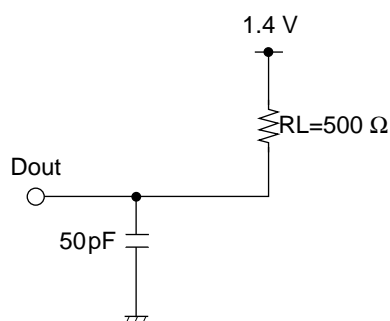

Output load (B)
(V_{CC} = 2.7 V to 3.6 V)

Read Cycle

Parameter	Symbol	HM62V16256C		Unit	Notes
		-5			
		Min	Max		
Read cycle time	t_{RC}	55	—	ns	
Address access time	t_{AA}	—	55	ns	
Chip select access time	t_{ACS1}	—	55	ns	
	t_{ACS2}	—	55	ns	
Output enable to output valid	t_{OE}	—	35	ns	
Output hold from address change	t_{OH}	10	—	ns	
\overline{LB} , \overline{UB} access time	t_{BA}	—	55	ns	
Chip select to output in low-Z	t_{CLZ1}	10	—	ns	2, 3
	t_{CLZ2}	10	—	ns	2, 3
\overline{LB} , \overline{UB} enable to low-z	t_{BLZ}	5	—	ns	2, 3
Output enable to output in low-Z	t_{OLZ}	5	—	ns	2, 3
Chip deselect to output in high-Z	t_{CHZ1}	0	20	ns	1, 2, 3
	t_{CHZ2}	0	20	ns	1, 2, 3
\overline{LB} , \overline{UB} disable to high-Z	t_{BHZ}	0	20	ns	1, 2, 3
Output disable to output in high-Z	t_{OHZ}	0	20	ns	1, 2, 3

Write Cycle

Parameter	Symbol	HM62V16256C		Unit	Notes
		-5			
		Min	Max		
Write cycle time	t_{WC}	55	—	ns	
Address valid to end of write	t_{AW}	50	—	ns	
Chip selection to end of write	t_{CW}	50	—	ns	5
Write pulse width	t_{WP}	40	—	ns	4
\overline{LB} , \overline{UB} valid to end of write	t_{BW}	50	—	ns	
Address setup time	t_{AS}	0	—	ns	6
Write recovery time	t_{WR}	0	—	ns	7
Data to write time overlap	t_{DW}	25	—	ns	
Data hold from write time	t_{DH}	0	—	ns	
Output active from end of write	t_{OW}	5	—	ns	2
Output disable to output in High-Z	t_{OHZ}	0	20	ns	1, 2
Write to output in high-Z	t_{WHZ}	0	20	ns	1, 2

- Notes:
- t_{CHZ} , t_{OHZ} , t_{WHZ} and t_{BHZ} are defined as the time at which the outputs achieve the open circuit conditions and are not referred to output voltage levels.
 - This parameter is sampled and not 100% tested.
 - At any given temperature and voltage condition, t_{HZ} max is less than t_{LZ} min both for a given device and from device to device.
 - A write occurs during the overlap of a low $\overline{CS1}$, a high CS2, a low \overline{WE} and a low \overline{LB} or a low \overline{UB} . A write begins at the latest transition among $\overline{CS1}$ going low, CS2 going high, \overline{WE} going low and \overline{LB} going low or \overline{UB} going low. A write ends at the earliest transition among $\overline{CS1}$ going high, CS2 going low, \overline{WE} going high and \overline{LB} going high or \overline{UB} going high. t_{WP} is measured from the beginning of write to the end of write.
 - t_{CW} is measured from the later of $\overline{CS1}$ going low or CS2 going high to the end of write.
 - t_{AS} is measured from the address valid to the beginning of write.
 - t_{WR} is measured from the earliest of $\overline{CS1}$ or \overline{WE} going high or CS2 going low to the end of write cycle.

Timing Waveform

Read Cycle

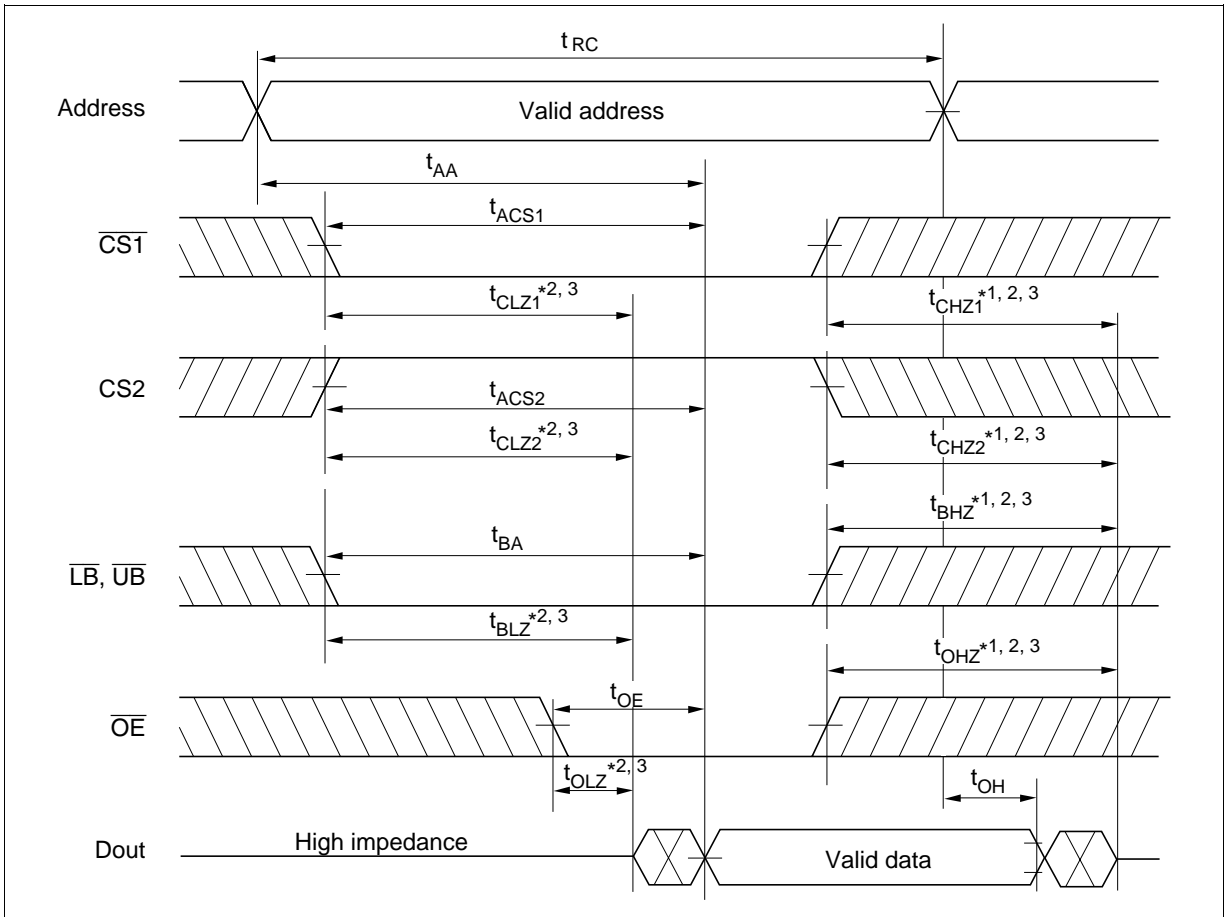

Write Cycle (1) ($\overline{\text{WE}}$ Clock)

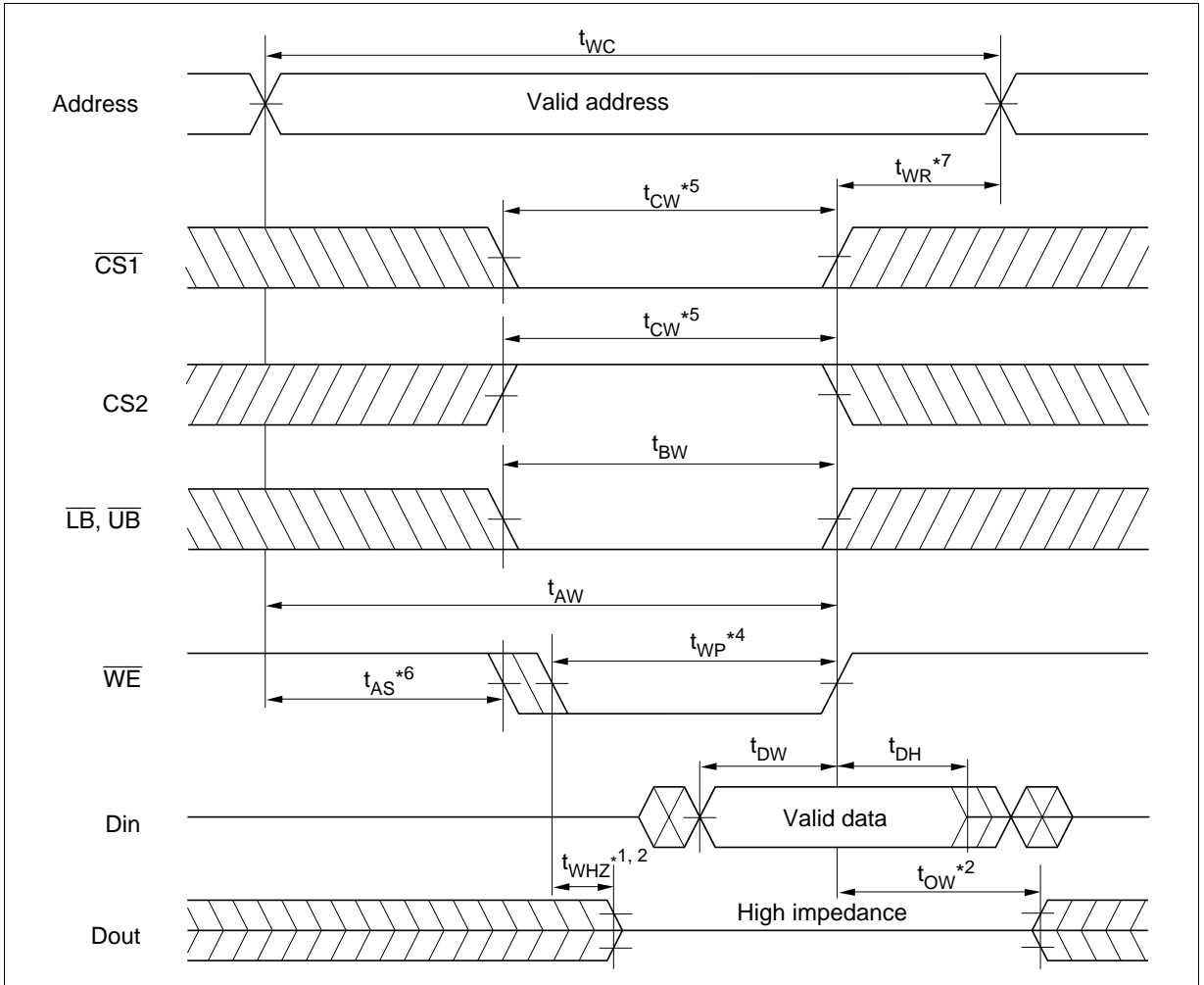

Write Cycle (2) ($\overline{\text{CS}}$ Clock, $\overline{\text{OE}} = V_{\text{IH}}$)

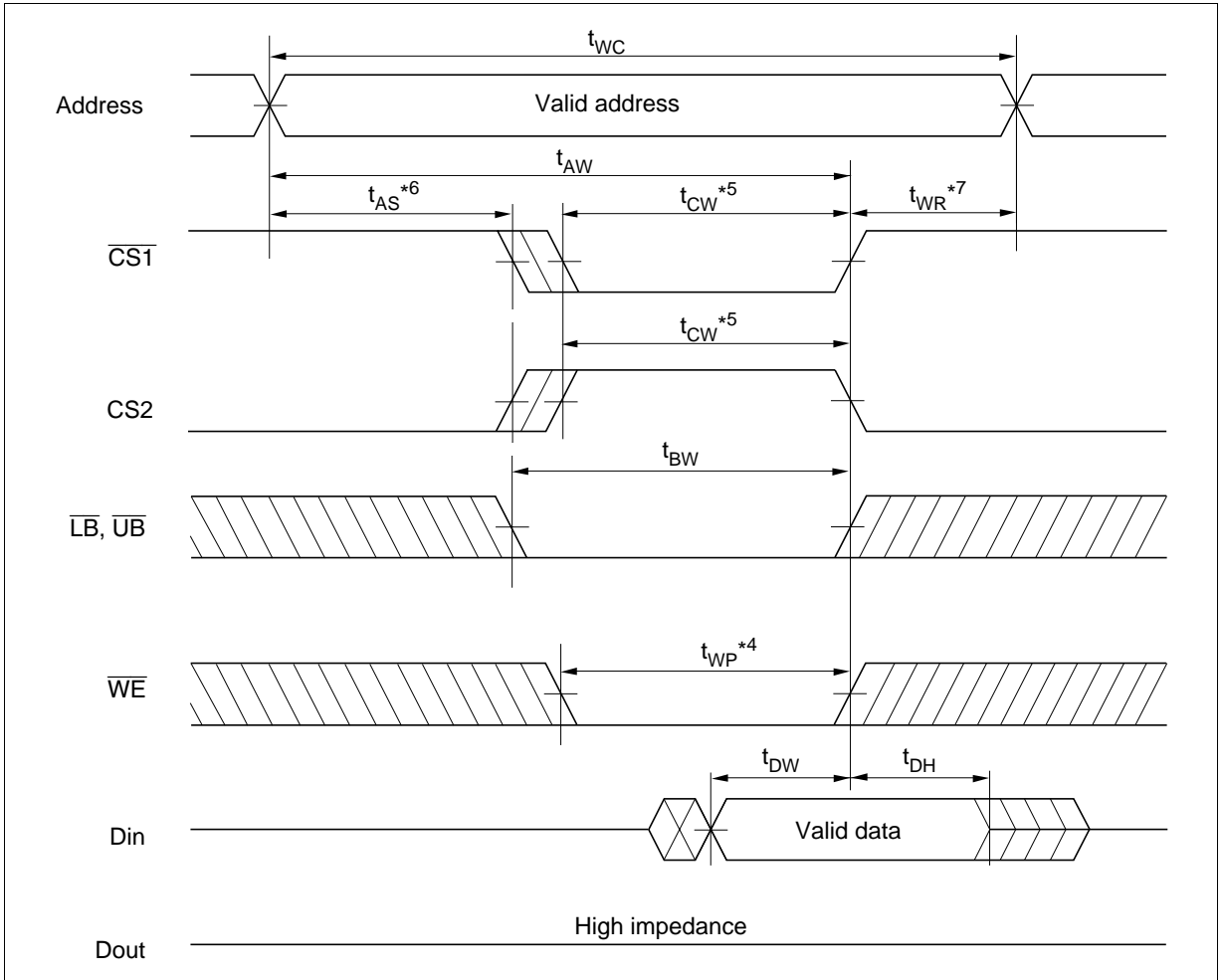

HM62V16256C Series

Write Cycle (3) ($\overline{\text{LB}}$, $\overline{\text{UB}}$ Clock, $\overline{\text{OE}} = V_{\text{IH}}$)

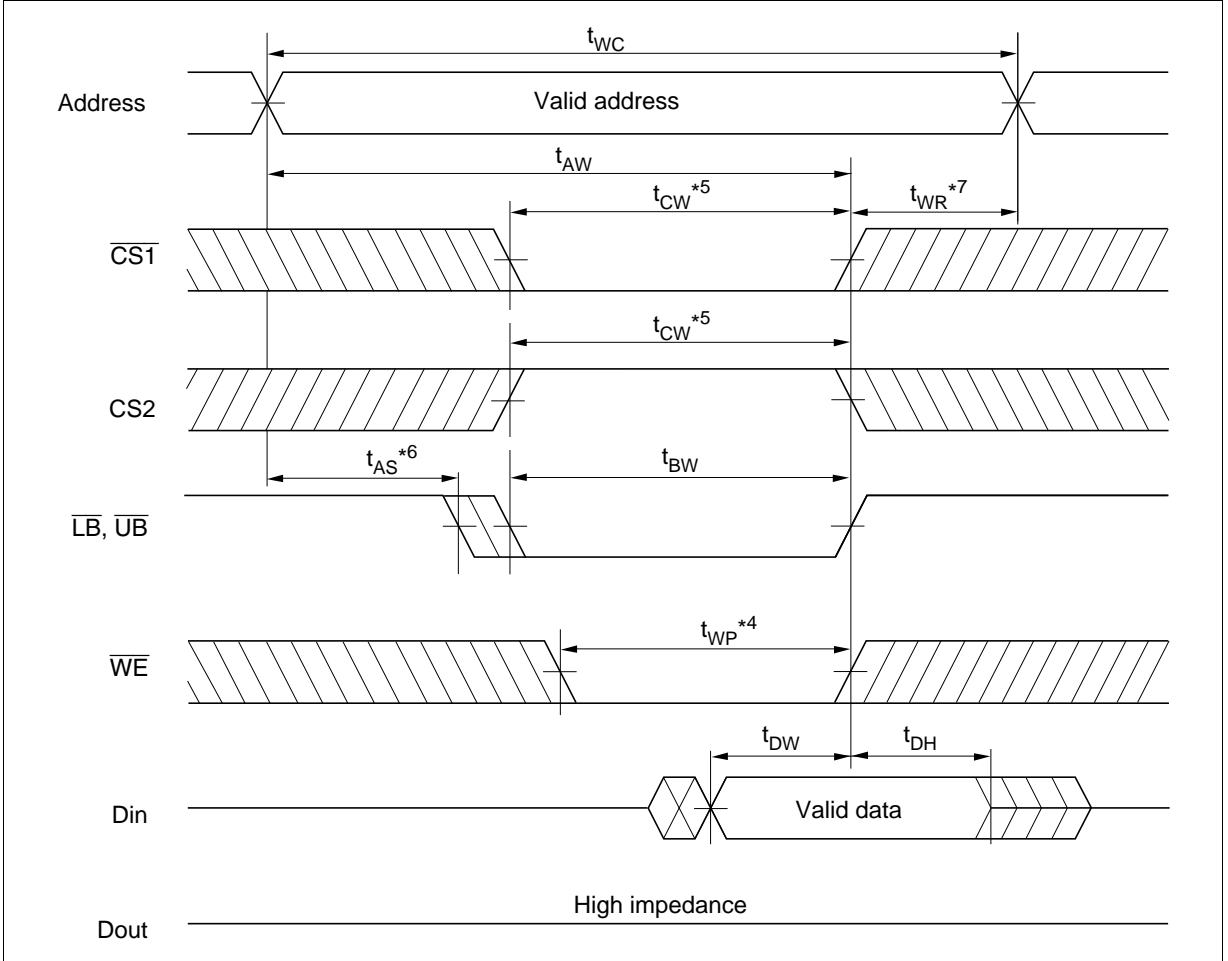

Low V_{CC} Data Retention Characteristics ($T_a = -20$ to $+70^\circ\text{C}$)

Parameter	Symbol	Min	Typ* ⁴	Max	Unit	Test conditions* ³
V_{CC} for data retention	V_{DR}	2.0	—	3.6	V	$V_{in} \geq 0V$ (1) $0V \leq CS2 \leq 0.2V$ or (2) $CS2 \geq V_{CC} - 0.2V$ $\overline{CS1} \geq V_{CC} - 0.2V$ or (3) $\overline{LB} = \overline{UB} \geq V_{CC} - 0.2V$, $CS2 \geq V_{CC} - 0.2V$, $\overline{CS1} \leq 0.2V$
Data retention current	I_{CCDR}^{*1}	—	0.5	20	μA	$V_{CC} = 3.0V$, $V_{in} \geq 0V$ (1) $0V \leq CS2 \leq 0.2V$ or (2) $CS2 \geq V_{CC} - 0.2V$, $\overline{CS1} \geq V_{CC} - 0.2V$ or (3) $\overline{LB} = \overline{UB} \geq V_{CC} - 0.2V$, $CS2 \geq V_{CC} - 0.2V$, $\overline{CS1} \leq 0.2V$
	I_{CCDR}^{*2}	—	0.5	10	μA	
Chip deselect to data retention time	t_{CDR}	0	—	—	ns	See retention waveform
Operation recovery time	t_R	t_{RC}^{*5}	—	—	ns	

- Notes:
1. This characteristic is guaranteed only for L-version, 10 μA max. at $T_a = -20$ to $+40^\circ\text{C}$.
 2. This characteristic is guaranteed only for L-SL version, 3 μA max. at $T_a = -20$ to $+40^\circ\text{C}$.
 3. CS2 controls address buffer, \overline{WE} buffer, $\overline{CS1}$ buffer, \overline{OE} buffer, \overline{LB} , \overline{UB} buffer and Din buffer. If CS2 controls data retention mode, V_{in} levels (address, \overline{WE} , \overline{OE} , $\overline{CS1}$, \overline{LB} , \overline{UB} , I/O) can be in the high impedance state. If $\overline{CS1}$ controls data retention mode, CS2 must be $CS2 \geq V_{CC} - 0.2V$ or $0V \leq CS2 \leq 0.2V$. The other input levels (address, \overline{WE} , \overline{OE} , \overline{LB} , \overline{UB} , I/O) can be in the high impedance state.
 4. Typical values are at $V_{CC} = 3.0V$, $T_a = +25^\circ\text{C}$ and not guaranteed.
 5. t_{RC} = read cycle time.

Low V_{CC} Data Retention Timing Waveform (1) ($\overline{CS1}$ Controlled)

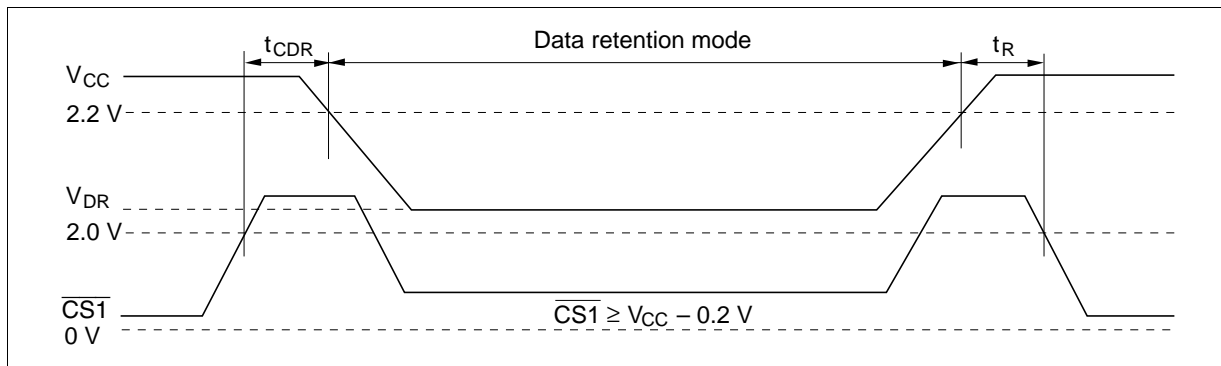

Low V_{CC} Data Retention Timing Waveform (2) ($CS2$ Controlled)

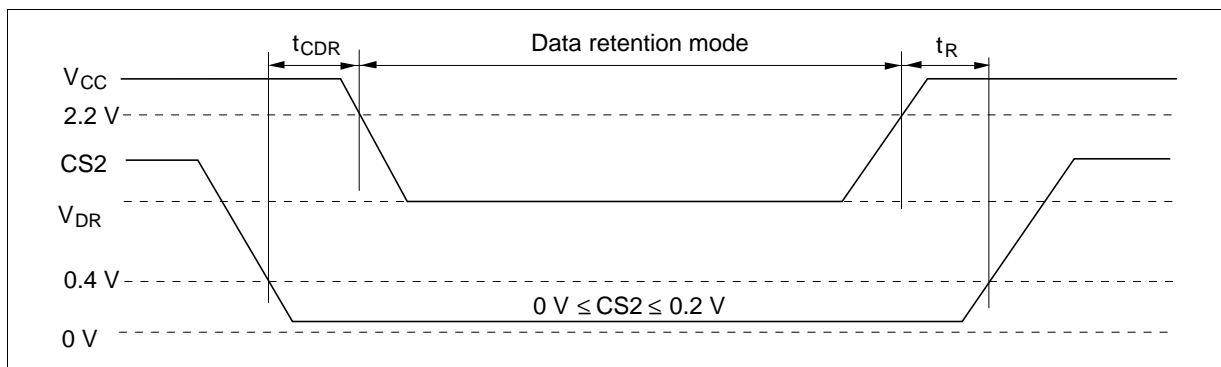

Low V_{CC} Data Retention Timing Waveform (3) (\overline{LB} , \overline{UB} Controlled)

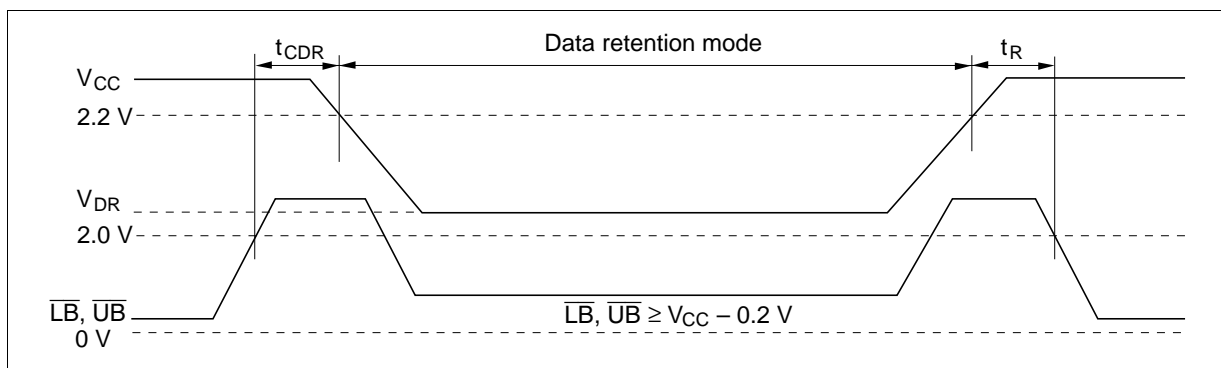

Package Dimensions

HM62V16256CLTT Series (TTP-44DB)

As of January, 2002

Unit: mm

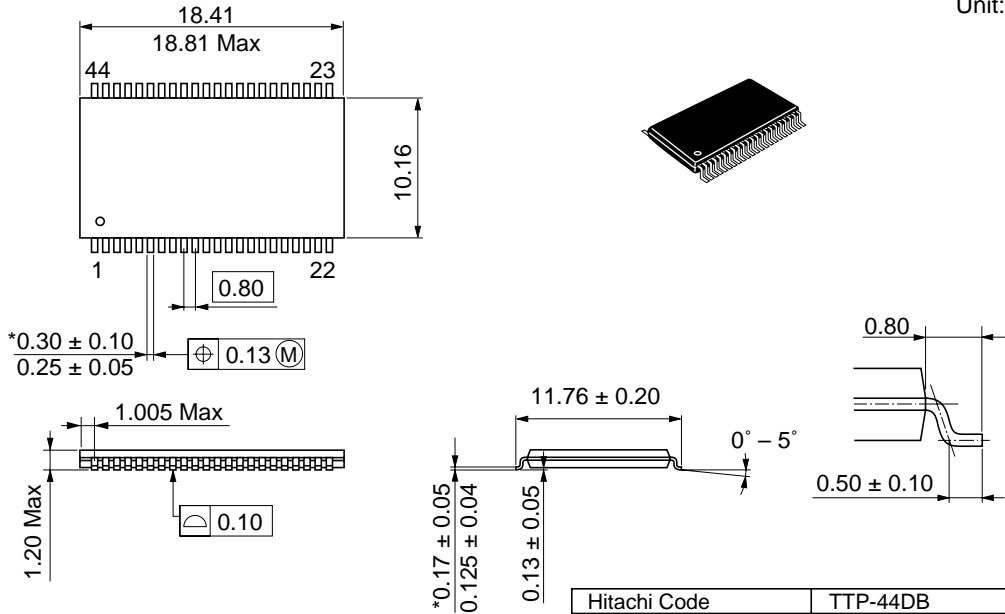

*Dimension including the plating thickness
Base material dimension

Hitachi Code	TTP-44DB
JEDEC	—
JEITA	—
Mass (reference value)	0.43 g

Cautions

1. Hitachi neither warrants nor grants licenses of any rights of Hitachi's or any third party's patent, copyright, trademark, or other intellectual property rights for information contained in this document. Hitachi bears no responsibility for problems that may arise with third party's rights, including intellectual property rights, in connection with use of the information contained in this document.
2. Products and product specifications may be subject to change without notice. Confirm that you have received the latest product standards or specifications before final design, purchase or use.
3. Hitachi makes every attempt to ensure that its products are of high quality and reliability. However, contact Hitachi's sales office before using the product in an application that demands especially high quality and reliability or where its failure or malfunction may directly threaten human life or cause risk of bodily injury, such as aerospace, aeronautics, nuclear power, combustion control, transportation, traffic, safety equipment or medical equipment for life support.
4. Design your application so that the product is used within the ranges guaranteed by Hitachi particularly for maximum rating, operating supply voltage range, heat radiation characteristics, installation conditions and other characteristics. Hitachi bears no responsibility for failure or damage when used beyond the guaranteed ranges. Even within the guaranteed ranges, consider normally foreseeable failure rates or failure modes in semiconductor devices and employ systemic measures such as fail-safes, so that the equipment incorporating Hitachi product does not cause bodily injury, fire or other consequential damage due to operation of the Hitachi product.
5. This product is not designed to be radiation resistant.
6. No one is permitted to reproduce or duplicate, in any form, the whole or part of this document without written approval from Hitachi.
7. Contact Hitachi's sales office for any questions regarding this document or Hitachi semiconductor products.

HITACHI

Hitachi, Ltd.

Semiconductor & Integrated Circuits

Nippon Bldg., 2-6-2, Ohte-machi, Chiyoda-ku, Tokyo 100-0004, Japan

Tel: (03) 3270-2111 Fax: (03) 3270-5109

URL <http://www.hitachisemiconductor.com/>

For further information write to:

Hitachi Semiconductor
(America) Inc.
179 East Tasman Drive
San Jose, CA 95134
Tel: <1>(408) 433-1990
Fax: <1>(408) 433-0223

Hitachi Europe Ltd.
Electronic Components Group
Whitebrook Park
Lower Cookham Road
Maidenhead
Berkshire SL6 8YA, United Kingdom
Tel: <44> (1628) 585000
Fax: <44> (1628) 585200

Hitachi Europe GmbH
Electronic Components Group
Dornacher Strasse 3
D-85622 Feldkirchen
Postfach 201, D-85619 Feldkirchen
Germany
Tel: <49> (89) 9 9180-0
Fax: <49> (89) 9 29 30 00

Hitachi Asia Ltd.
Hitachi Tower
16 Collyer Quay #20-00
Singapore 049318
Tel: <65>-6538-6533/6538-8577
Fax: <65>-6538-6933/6538-3877
URL: <http://semiconductor.hitachi.com.sg>

Hitachi Asia Ltd.
(Taipei Branch Office)
4/F, No. 167, Tun Hwa North Road
Hung-Kuo Building
Taipei (105), Taiwan
Tel: <886>-(2)-2718-3666
Fax: <886>-(2)-2718-8180
Telex: 23222 HAS-TP
URL: <http://www.hitachi.com.tw>

Hitachi Asia (Hong Kong) Ltd.
Group III (Electronic Components)
7/F., North Tower
World Finance Centre,
Harbour City, Canton Road
Tsim Sha Tsui, Kowloon Hong Kong
Tel: <852>-2735-9218
Fax: <852>-2730-0281
URL: <http://semiconductor.hitachi.com.hk>

Copyright©Hitachi, Ltd., 2002. All rights reserved. Printed in Japan.

Colophon 6.0