

To all our customers

Regarding the change of names mentioned in the document, such as Mitsubishi Electric and Mitsubishi XX, to Renesas Technology Corp.

The semiconductor operations of Hitachi and Mitsubishi Electric were transferred to Renesas Technology Corporation on April 1st 2003. These operations include microcomputer, logic, analog and discrete devices, and memory chips other than DRAMs (flash memory, SRAMs etc.) Accordingly, although Mitsubishi Electric, Mitsubishi Electric Corporation, Mitsubishi Semiconductors, and other Mitsubishi brand names are mentioned in the document, these names have in fact all been changed to Renesas Technology Corp. Thank you for your understanding. Except for our corporate trademark, logo and corporate statement, no changes whatsoever have been made to the contents of the document, and these changes do not constitute any alteration to the contents of the document itself.

Note : Mitsubishi Electric will continue the business operations of high frequency & optical devices and power devices.

Renesas Technology Corp.
Customer Support Dept.
April 1, 2003

BCR8PM-20

MEDIUM POWER USE
INSULATED TYPE, PLANAR PASSIVATION TYPE

BCR8PM-20



- IT (RMS) 8A
- VDRM 1000V
- IFGT I, IRGT I, IRGT III 30mA
- V_{iso} 2000V
- UL Recognized: Yellow Card No.E80276(N)
File No. E80271

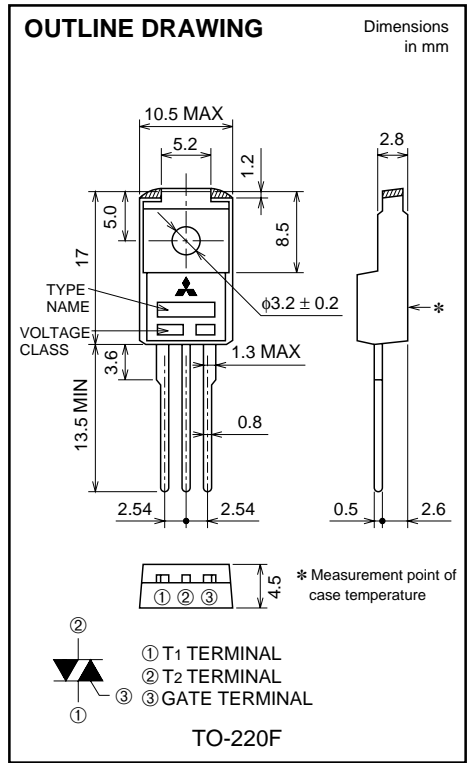

APPLICATION

Switching mode power supply, light dimmer, electric flasher unit, control of household equipment such as TV sets · stereo · refrigerator · washing machine · infrared kotatsu · carpet, solenoid drivers, small motor control, copying machine, electric tool, other general purpose control applications

MAXIMUM RATINGS

Symbol	Parameter	Voltage class	
		20	Unit
VDRM	Repetitive peak off-state voltage *1	1000	V
VDSM	Non-repetitive peak off-state voltage *1	1200	V

Symbol	Parameter	Conditions	Ratings	Unit
IT (RMS)	RMS on-state current	Commercial frequency, sine full wave 360° conduction, T _c =88°C	8	A
ITSM	Surge on-state current	60Hz sinewave 1 full cycle, peak value, non-repetitive	80	A
I ² _t	I ² _t for fusing	Value corresponding to 1 cycle of half wave 60Hz, surge on-state current	26	A ² s
P _{GM}	Peak gate power dissipation		5	W
P _{G (AV)}	Average gate power dissipation		0.5	W
V _{GM}	Peak gate voltage		10	V
I _{GM}	Peak gate current		2	A
T _j	Junction temperature		-40 ~ +125	°C
T _{stg}	Storage temperature		-40 ~ +125	°C
—	Weight	Typical value	2.0	g
V _{iso}	Isolation voltage	T _a =25°C, AC 1 minute, T1 · T2 · G terminal to case	2000	V

*1. Gate open.

BCR8PM-20

MEDIUM POWER USE
INSULATED TYPE, PLANAR PASSIVATION TYPE

ELECTRICAL CHARACTERISTICS

Symbol	Parameter	Test conditions	Limits			Unit	
			Min.	Typ.	Max.		
IDRM	Repetitive peak off-state current	$T_j=125^\circ\text{C}$, V_{DRM} applied	—	—	2.0	mA	
V _{TM}	On-state voltage	$T_c=25^\circ\text{C}$, $I_{\text{TM}}=12\text{A}$, Instantaneous measurement	—	—	1.6	V	
V _{FGT I}	Gate trigger voltage *2	$T_j=25^\circ\text{C}$, $V_D=6\text{V}$, $R_L=6\Omega$, $R_G=330\Omega$	I	—	—	1.5	V
V _{RGT I}			II	—	—	1.5	V
V _{RGT III}			III	—	—	1.5	V
I _{FGT I}	Gate trigger current *2	$T_j=25^\circ\text{C}$, $V_D=6\text{V}$, $R_L=6\Omega$, $R_G=330\Omega$	I	—	—	30	mA
I _{RGT I}			II	—	—	30	mA
I _{RGT III}			III	—	—	30	mA
V _{GD}	Gate non-trigger voltage	$T_j=125^\circ\text{C}$, $V_D=1/2V_{\text{DRM}}$	0.2	—	—	V	
R _{th(j-c)}	Thermal resistance	Junction to case *3	—	—	3.7	$^\circ\text{C}/\text{W}$	
(dv/dt) _c	Critical-rate of rise of off-state commutating voltage *4	$T_j=125^\circ\text{C}$	10	—	—	V/ μs	

*2. Measurement using the gate trigger characteristics measurement circuit.

*3. The contact thermal resistance R_{th(c-f)} in case of greasing is 0.5 $^\circ\text{C}/\text{W}$.

*4. Test conditions of the critical-rate of rise of off-state commutating voltage is shown in the table below.

Test conditions	Commutating voltage and current waveforms (inductive load)
1. Junction temperature $T_j=125^\circ\text{C}$ 2. Rate of decay of on-state commutating current $(di/dt)_c=-4.0\text{A}/\text{ms}$ 3. Peak off-state voltage $V_D=400\text{V}$	

PERFORMANCE CURVES

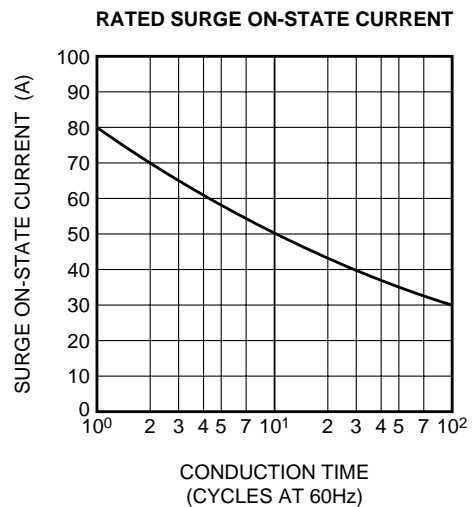
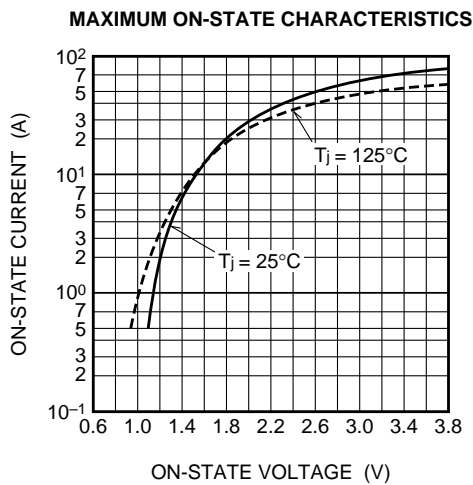

BCR8PM-20

MEDIUM POWER USE
INSULATED TYPE, PLANAR PASSIVATION TYPE

GATE CHARACTERISTICS

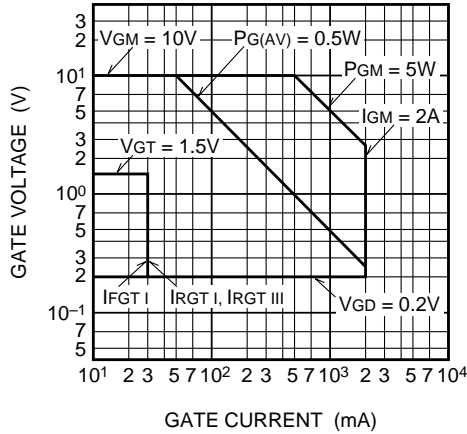

GATE TRIGGER CURRENT VS. JUNCTION TEMPERATURE

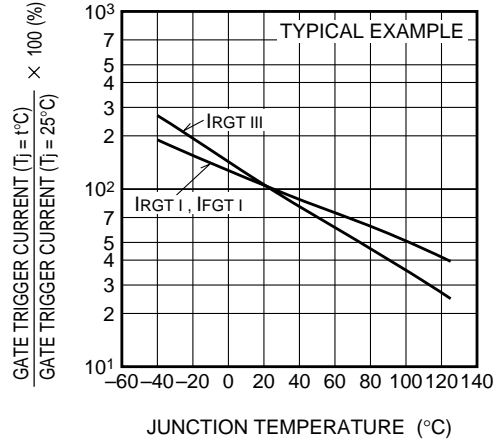

GATE TRIGGER VOLTAGE VS. JUNCTION TEMPERATURE

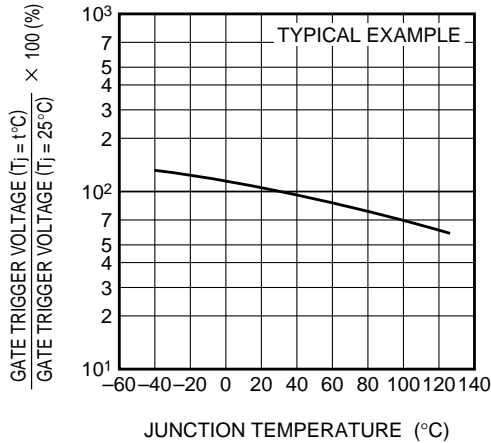

MAXIMUM TRANSIENT THERMAL IMPEDANCE CHARACTERISTICS (JUNCTION TO CASE)

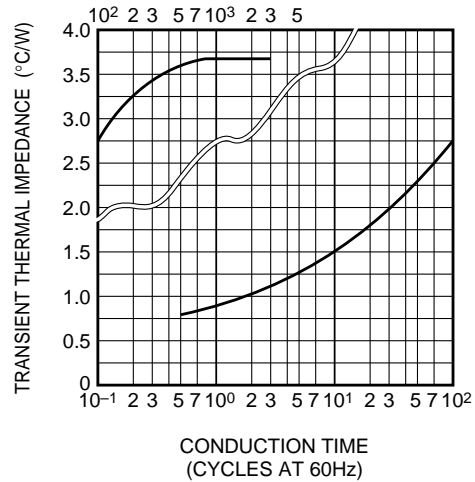

MAXIMUM TRANSIENT THERMAL IMPEDANCE CHARACTERISTICS (JUNCTION TO AMBIENT)

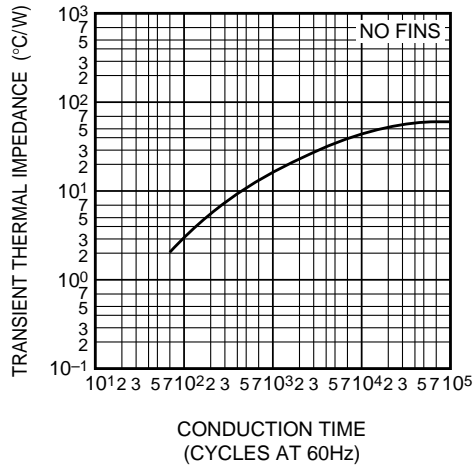

MAXIMUM ON-STATE POWER DISSIPATION

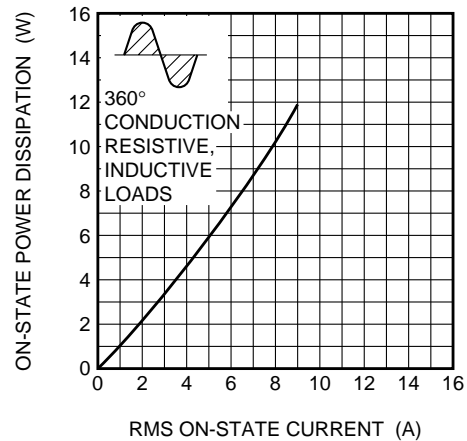

BCR8PM-20

MEDIUM POWER USE
INSULATED TYPE, PLANAR PASSIVATION TYPE

ALLOWABLE CASE TEMPERATURE VS. RMS ON-STATE CURRENT

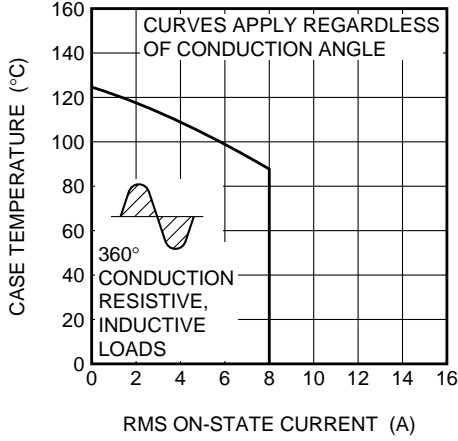

ALLOWABLE AMBIENT TEMPERATURE VS. RMS ON-STATE CURRENT

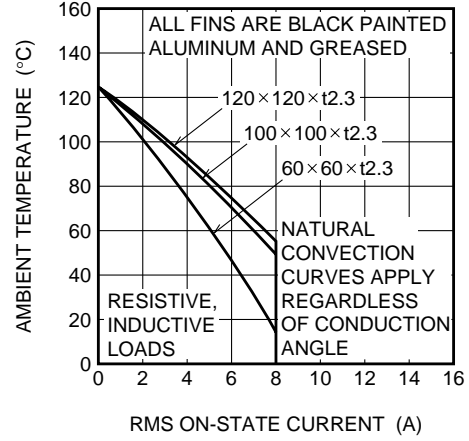

ALLOWABLE AMBIENT TEMPERATURE VS. RMS ON-STATE CURRENT

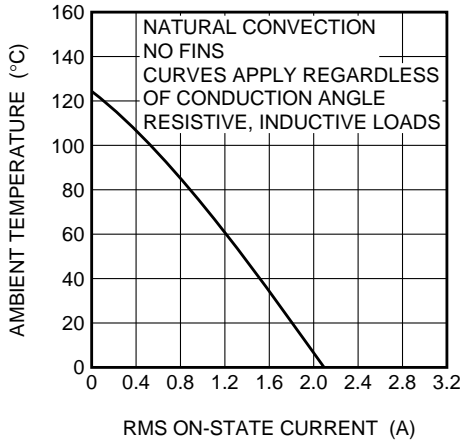

REPETITIVE PEAK OFF-STATE CURRENT VS. JUNCTION TEMPERATURE

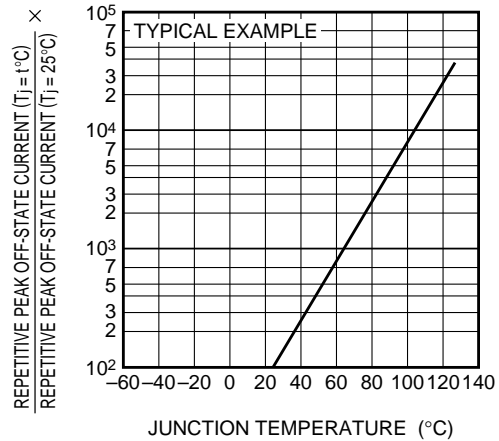

HOLDING CURRENT VS. JUNCTION TEMPERATURE

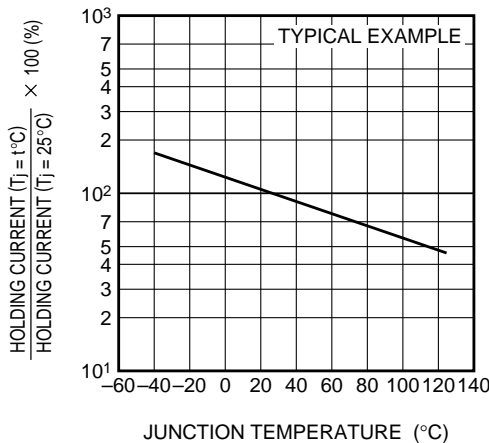

LACHING CURRENT VS. JUNCTION TEMPERATURE

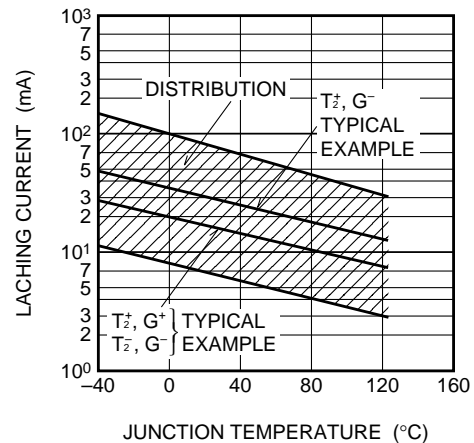

BCR8PM-20

MEDIUM POWER USE
INSULATED TYPE, PLANAR PASSIVATION TYPE

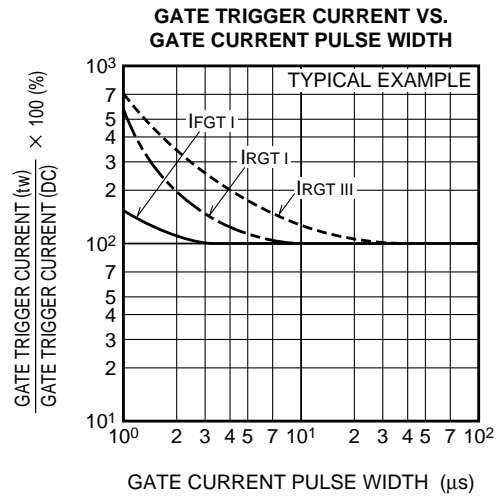
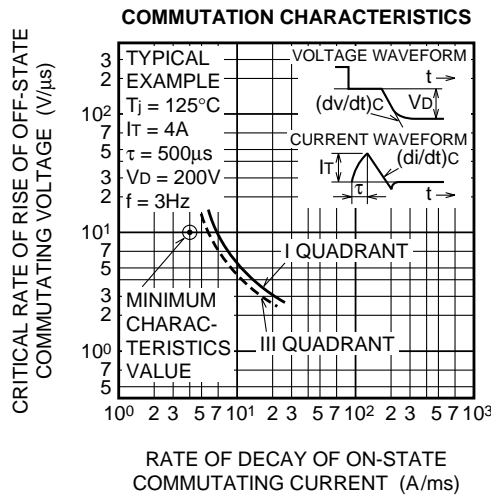
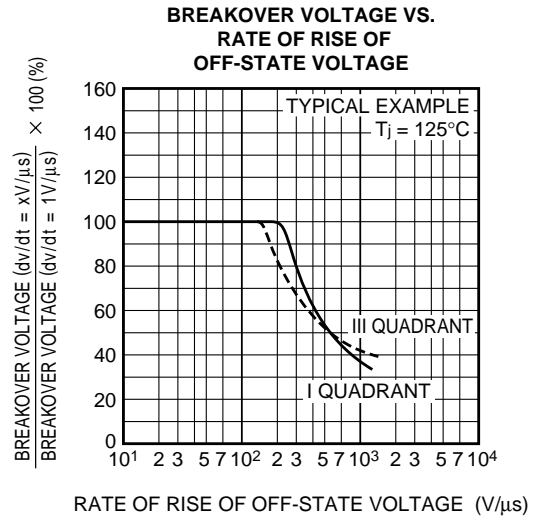
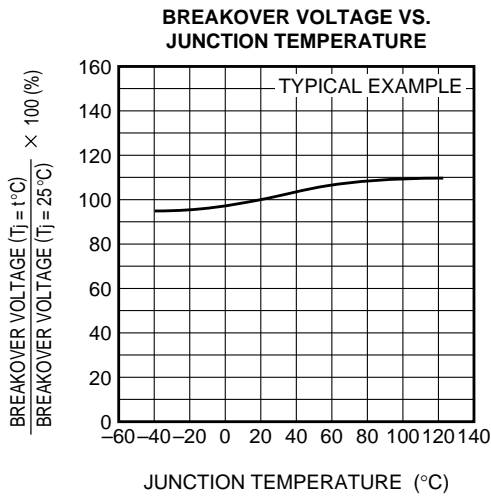

GATE TRIGGER CHARACTERISTICS TEST CIRCUITS

