

74ABT126 Quad Buffer with 3-STATE Outputs

General Description

The ABT126 contains four independent non-inverting buffers with 3-STATE outputs.

Features

- Non-inverting buffers
- Output sink capability of 64 mA, source capability of 32 mA
- Guaranteed latchup protection
- High impedance glitch free bus loading during entire power up and power down cycle
- Nondestructive hot insertion capability
- Disable time less than enable time to avoid bus contention

Ordering Code:

Order Number	Package Number	Package Description
74ABT126CSC	M14A	14-Lead Small Outline Integrated Circuit (SOIC), JEDEC MS-120, 0.150" Narrow Body
74ABT126CSJ	M14D	14-Lead Small Outline Package (SOP), EIAJ TYPE II, 5.3mm Wide
74ABT126CMTC	MTC14	14-Lead Thin Shrink Small Outline Package (TSSOP), JEDEC MO-153, 4.4mm Wide

Devices also available in Tape and Reel. Specify by appending suffix letter "X" to the ordering code.

Connection Diagram

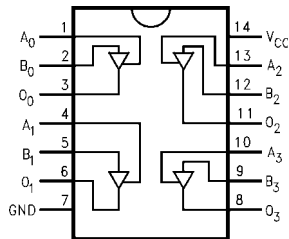

Pin Descriptions

Pin Names	Descriptions
A_n, B_n	Inputs
O_n	Outputs

Function Table

Inputs		Output
A_n	B_n	O_n
H	L	L
H	H	H
L	X	Z

H = HIGH Voltage Level
L = LOW Voltage Level
Z = HIGH Impedance
X = Immaterial

Absolute Maximum Ratings (Note 1)

Storage Temperature	-65°C to +150°C
Ambient Temperature under Bias	-55°C to +125°C
Junction Temperature under Bias	-55°C to +150°C
V _{CC} Pin Potential to Ground Pin	-0.5V to +7.0V
Input Voltage (Note 2)	-0.5V to +7.0V
Input Current (Note 2)	-30 mA to +5.0 mA
Voltage Applied to Any Output in the Disabled or Power-Off State	-0.5V to 5.5V
in the HIGH State	-0.5V to V _{CC}
Current Applied to Output in LOW State (Max)	twice the rated I _{OL} (mA)
DC Latchup Source Current (Across Comm Operating Range)	-300 mA
Over Voltage Latchup (I/O)	10V

Recommended Operating Conditions

Free Air Ambient Temperature	-40°C to +85°C
Supply Voltage	+4.5V to +5.5V
Minimum Input Edge Rate ($\Delta V/\Delta t$)	
Data Input	50 mV/ns
Enable Input	100 mV/ns

Note 1: Absolute maximum ratings are values beyond which the device may be damaged or have its useful life impaired. Functional operation under these conditions is not implied.

Note 2: Either voltage limit or current limit is sufficient to protect inputs.

DC Electrical Characteristics

Symbol	Parameter	Min	Typ	Max	Units	V _{CC}	Conditions
V _{IH}	Input HIGH Voltage	2.0			V		Recognized HIGH Signal
V _{IL}	Input LOW Voltage			0.8	V		Recognized LOW Signal
V _{CD}	Input Clamp Diode Voltage			-1.2	V	Min	I _{IN} = -18 mA
V _{OH}	Output HIGH Voltage	2.5			V	Min	I _{OH} = -3 mA
		2.0			V	Min	I _{OH} = -32 mA
V _{OL}	Output LOW Voltage			0.55	V	Min	I _{OL} = 64 mA
I _{IH}	Input HIGH Current			1	μA	Max	V _{IN} = 2.7V (Note 3)
				1	μA	Max	V _{IN} = V _{CC}
I _{BVI}	Input HIGH Current Breakdown Test			7	μA	Max	V _{IN} = 7.0V
I _{IL}	Input LOW Current			-1	μA	Max	V _{IN} = 0.5V (Note 3)
				-1	μA	Max	V _{IN} = 0.0V
V _{ID}	Input Leakage Test	4.75			V	0.0	I _{ID} = 1.9 μA, All Other Pin Grounded
I _{OZH}	Output Leakage Current			10	μA	0 - 5.5V	V _{OUT} = 2.7V; $\overline{OE}_n = 2.0V$
I _{OZL}	Output Leakage Current			-10	μA	0 - 5.5V	V _{OUT} = 0.5V; $\overline{OE}_n = 2.0V$
I _{OS}	Output Short-Circuit Current	-100		-275	mA	Max	V _{OUT} = 0.0V
I _{CEX}	Output HIGH Leakage Current			50	μA	Max	V _{OUT} = V _{CC}
I _{ZZ}	Bus Drainage Test			100	μA	0.0	V _{OUT} = 5.5V; All Others GND
I _{CCH}	Power Supply Current			50	μA	Max	All Outputs HIGH
I _{CCL}	Power Supply Current			15	mA	Max	All Outputs LOW
I _{CCZ}	Power Supply Current			50	μA	Max	$\overline{OE}_n = V_{CC}$; All Others at V _{CC} or Ground
I _{CCT}	Additional I _{CC} /Input	Outputs Enabled		1.5	mA	Max	V _I = V _{CC} - 2.1V
		Outputs 3-STATE		1.5	mA		Enable Input V _I = V _{CC} - 2.1V
		Outputs 3-STATE		50	μA		Data Input V _I = V _{CC} - 2.1V All Others at V _{CC} or Ground
I _{CCD}	Dynamic I _{CC} (Note 3)	No Load		0.1	mA/ MHz	Max	Outputs Open $\overline{OE}_n = GND$, (Note 4) One Bit Toggling, 50% Duty Cycle

Note 3: Guaranteed, but not tested.

Note 4: For 8 bits toggling, I_{CCD} < 0.8 mA/MHz.

AC Electrical Characteristics

Symbol	Parameter	$T_A = +25^\circ\text{C}$ $V_{CC} = +5\text{V}$ $C_L = 50\text{ pF}$			$T_A = -40^\circ\text{C to } +85^\circ\text{C}$ $V_{CC} = 4.5\text{V}-5.5\text{V}$ $C_L = 50\text{ pF}$		Units
		Min	Typ	Max	Min	Max	
t_{PLH}	Propagation Delay	1.0		4.4	1.0	4.4	ns
t_{PHL}	Data to Outputs	1.0		4.6	1.0	4.6	
t_{PZH}	Output Enable	1.0		6.5	1.0	6.5	ns
t_{PZL}	Time	1.0		6.5	1.0	6.5	
t_{PHZ}	Output Disable	1.0		5.8	1.0	5.8	ns
t_{PLZ}	Time	1.0		5.5	1.0	5.5	

Capacitance

Symbol	Parameter	Typ	Units	Conditions $T_A = 25^\circ\text{C}$
C_{IN}	Input Capacitance	5.0	pF	$V_{CC} = 0\text{V}$
C_{OUT} (Note 5)	Output Capacitance	9.0	pF	$V_{CC} = 5.0\text{V}$

Note 5: C_{OUT} is measured at frequency $f = 1\text{ MHz}$, per MIL-STD-883, Method 3012.

Physical Dimensions inches (millimeters) unless otherwise noted

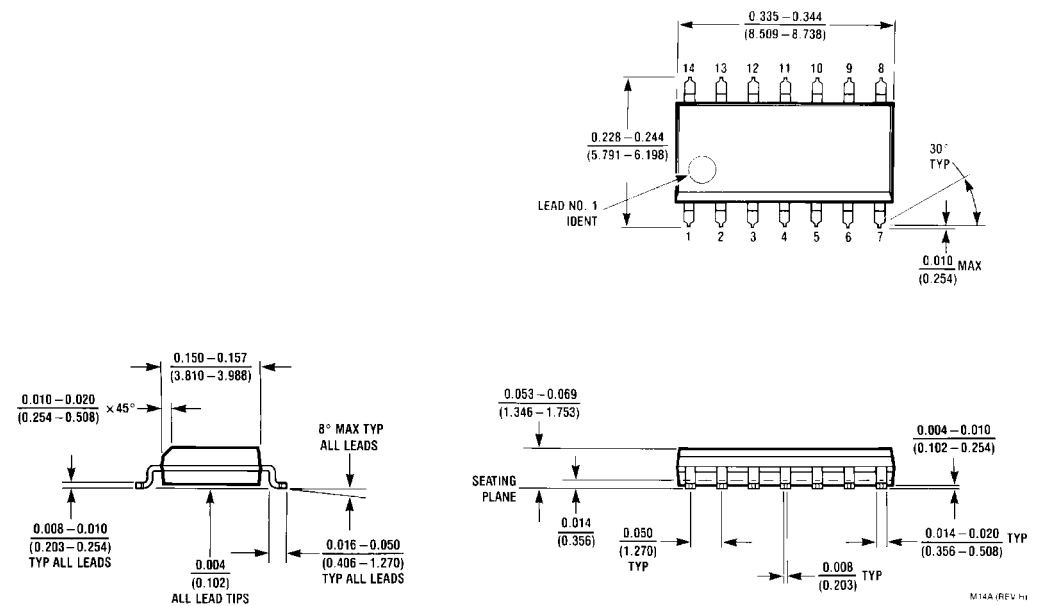

**14-Lead Small Outline Integrated Circuit (SOIC), JEDEC MS-120, 0.150" Narrow Body
Package Number M14A**

Physical Dimensions inches (millimeters) unless otherwise noted (Continued)



LAND PATTERN RECOMMENDATION



DIMENSIONS ARE IN MILLIMETERS

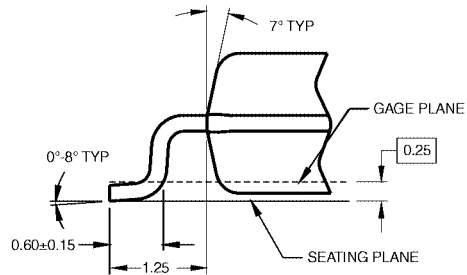

DETAIL A

- NOTES:
 A. CONFORMS TO EIAJ EDR-7320 REGISTRATION, ESTABLISHED IN DECEMBER, 1998.
 B. DIMENSIONS ARE IN MILLIMETERS.
 C. DIMENSIONS ARE EXCLUSIVE OF BURRS, MOLD FLASH, AND TIE BAR EXTRUSIONS.

M14DRevB1

**14-Lead Small Outline Package (SOP), EIAJ TYPE II, 5.3mm Wide
 Package Number M14D**

Physical Dimensions inches (millimeters) unless otherwise noted (Continued)

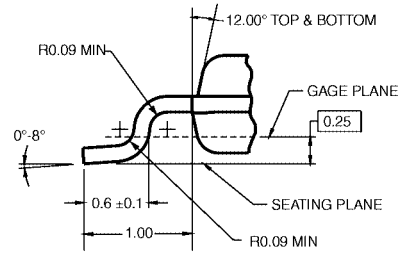
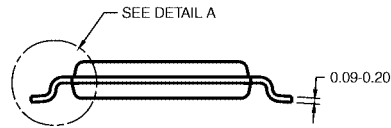
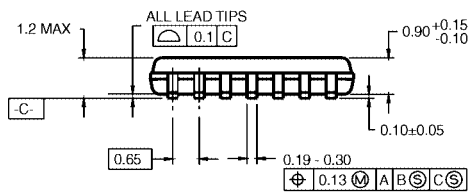
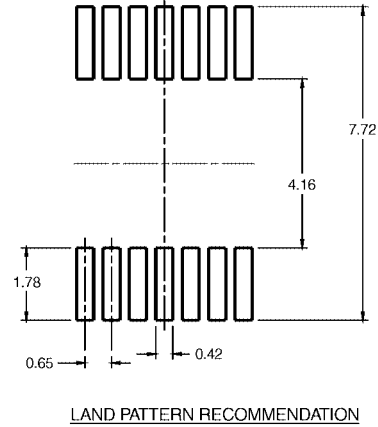
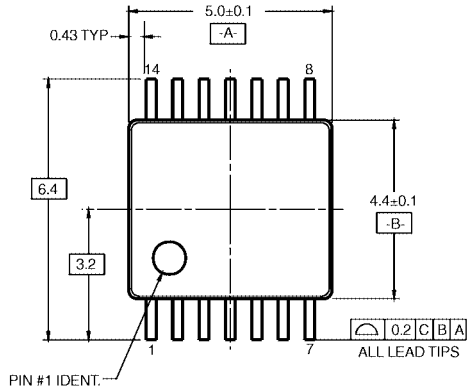

- NOTES:
- A. CONFORMS TO JEDEC REGISTRATION MO-153, VARIATION AB, REF NOTE 6, DATE 7/93.
 - B. DIMENSIONS ARE IN MILLIMETERS.
 - C. DIMENSIONS ARE EXCLUSIVE OF BURRS, MOLD FLASH, AND TIE BAR EXTRUSIONS.
 - D. DIMENSIONS AND TOLERANCES PER ANSI Y14.5M, 1982.

MTC14RevC3

14-Lead Thin Shrink Small Outline Package (TSSOP), JEDEC MO-153, 4.4mm Wide Package Number MTC14

Fairchild does not assume any responsibility for use of any circuitry described, no circuit patent licenses are implied and Fairchild reserves the right at any time without notice to change said circuitry and specifications.

LIFE SUPPORT POLICY

FAIRCHILD'S PRODUCTS ARE NOT AUTHORIZED FOR USE AS CRITICAL COMPONENTS IN LIFE SUPPORT DEVICES OR SYSTEMS WITHOUT THE EXPRESS WRITTEN APPROVAL OF THE PRESIDENT OF FAIRCHILD SEMICONDUCTOR CORPORATION. As used herein:

1. Life support devices or systems are devices or systems which, (a) are intended for surgical implant into the body, or (b) support or sustain life, and (c) whose failure to perform when properly used in accordance with instructions for use provided in the labeling, can be reasonably expected to result in a significant injury to the user.
2. A critical component in any component of a life support device or system whose failure to perform can be reasonably expected to cause the failure of the life support device or system, or to affect its safety or effectiveness.

www.fairchildsemi.com