

DESCRIPTION

The LX5503E is a power amplifier optimized for high-efficiency low-power applications in the FCC Unlicensed National Information Infrastructure (U-NII) band, Europe HyperLAN2, and Japan WLAN in the 4.9-5.85GHz frequency range. The PA is implemented as a two-stage monolithic microwave integrated circuit (MMIC) with active bias and input/output pre-matching. The device is manufactured with an InGaP/GaAs Heterojunction Bipolar Transistor (HBT) IC process (MOCVD). It operates at a single supply of 3.3V with +26dBm of P1dB, and power gain of 21dB between 4.9-5.35GHz and 16dB up to 5.85GHz.

For +18dBm OFDM output power (64QAM, 54Mbps), the PA provides a very low EVM (Error Vector Magnitude) of 3%, and consumes 150mA total DC current.

The LX5503E is available in a 16-pin 3x3mm² micro-lead package (MLP). The compact footprint, low profile, and excellent thermal capability of the micro-lead package make the LX5503E an ideal solution for broadband, medium-gain power amplifier requirements for IEEE 802.11a, and HiperLAN2 portable WLAN applications.

IMPORTANT: For the most current data, consult MICROSEMI's website: <http://www.microsemi.com>

KEY FEATURES

- Advanced InGaP HBT
- 4.9-5.85GHz Operation
- Single-Polarity 3.3V Supply
- Total Current ~ 150mA for Pout=18dBm at 5.25GHz
- P1dB ~ +26dBm across 4.9~5.85GHz
- Power Gain ~ 21dB at 5.25GHz & Pout=18dBm
- Power Gain ~ 16dB at 5.85GHz & Pout=18dBm
- EVM ~ 3% for 64QAM/ 54Mbps & Pout=18dBm
- Excellent Temperature Performance
- Simple Input/Output Match
- Minimal External Components
- Optional low-cost LDO for Optimal System Performance
- Small Footprint: 3x3mm²
- Low Profile: 0.9mm

APPLICATIONS/BENEFITS

- FCC-UNII Wireless
- IEEE 802.11a
- HiperLAN2

PRODUCT HIGHLIGHT

PACKAGE ORDER INFO

LQ	Plastic MLPQ 16-Pin
LX5503E-LQ	

Note: Available in Tape & Reel.
 Append the letter "T" to the part number.
 (i.e. LX5503E-LQT)

ABSOLUTE MAXIMUM RATINGS

DC Supply Voltage, RF off	6V
Collector Current	500mA
Total Power Dissipation.....	3W
RF Input Power	10dBm
Operation Ambient Temperature	-40 to +85°C
Maximum Junction Temperature (T _{JMAX}).....	150°C
Storage Temperature.....	-60 to 150°C

Note: Exceeding these ratings could cause damage to the device. All voltages are with respect to Ground. Currents are positive into, negative out of specified terminal.

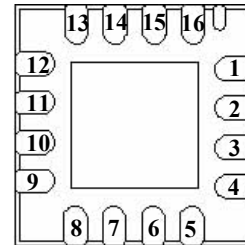
PACKAGE PIN OUT

LQ PACKAGE
(Bottom View)

FUNCTIONAL PIN DESCRIPTION

Name	Pin #	Description
RF IN	2, 3	RF input for the power amplifier. This pin is DC-shorted to GND but AC-coupled to the transistor base of the first stage.
VB1	6	Bias current control voltage for the first stage.
VB2	7	Bias current control voltage for the second stage. The VB2 pin can be connected with VB1 into a single reference voltage (V _{ref}) through an external resistor bridge.
VCC	9	Supply voltage for the Bias reference and control circuits. This pin can be combined with both VC1 and VC2 pins, resulting in a single supply voltage (referred to as V _c).
RF OUT	10, 11	RF output for the power amplifier. This pin is AC-coupled and does not require a DC-blocking capacitor.
VC1	15	Power supply for first stage amplifier. The VC1 feedline should be terminated with a 220pF bypass capacitor as close to the device as possible, followed by a 1μF bypass capacitor at the supply side. This pin can be combined with VC2 and VCC pins, resulting in a single supply voltage (V _c).
VC2	14	Power supply for second stage amplifier. The VC2 feedline should be terminated with a 220pF bypass capacitor as close to the device as possible, followed by a 1μF bypass capacitor at the supply side. This pin can be combined with VC1 and VCC, resulting in a single supply voltage (V _c).
GND	Center Metal	The center metal base of the MLPQ package provides both DC/RF ground as well as heat sink for the power amplifier.

ELECTRICAL CHARACTERISTICS

Unless otherwise specified, the following specifications apply over the following test conditions: $V_{cc} = 3.3V$, $I_{cq} = 100mA$, $T_A = 25^\circ C$

PARAMETER	CONDITION	SYMBOL	MIN.	TYP.	MAX.	MIN.	TYP.	MAX.	UNIT
Frequency Range		f	4.9		5.35	5.7		5.85	GHz
Output Power at 1dB Compression		Pout	25	26		25	26		dBm
Power Gain at Pout=18dBm		Gp		21			16		dB
EVM at Pout=18dBm	64QAM/54Mbps			3			3		%
Total Current at Pout=18dBm		Ic_total		150			160		mA
Quiescent Current		Icq		100			100		mA
Bias Control Reference Current	For Icq=100mA	Iref		1.5			1.5		mA
Small-Signal Gain		S21		19			15		dB
Gain Flatness	Over 200MHz	$\Delta S21$		+/-0.5			+/-0.5		dB
Gain Variation Over Temperature	-40 to +85°C	$\Delta S21$		+/-1			+/-1		dB
Input Return Loss		S11		-15	-10		-12	-10	dB
Output Return Loss		S22		-7			-8		dB
Reverse Isolation		S12		-35			-35		dB
Second Harmonic	Pout = 18dBm			-40			-35		dBc
Third Harmonic	Pout = 18dBm			-45			-45		dBc
Ramp-On Time	10~90%	t _{ON}		100			100		ns

CHARACTERISTIC CURVES

Typical EVM & Total Current vs. Output Power

(Vc=3.3V, Icq=100mA, 64QAM/54Mbps)

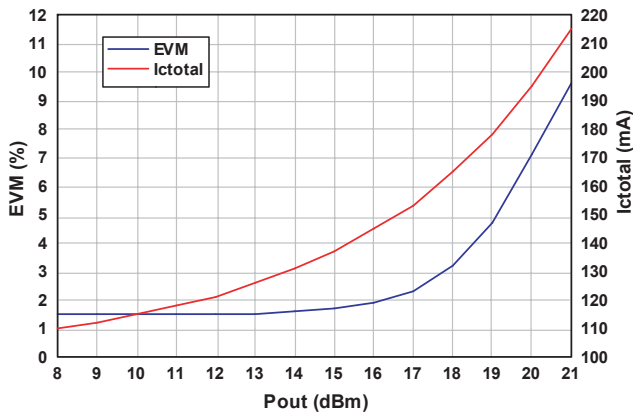
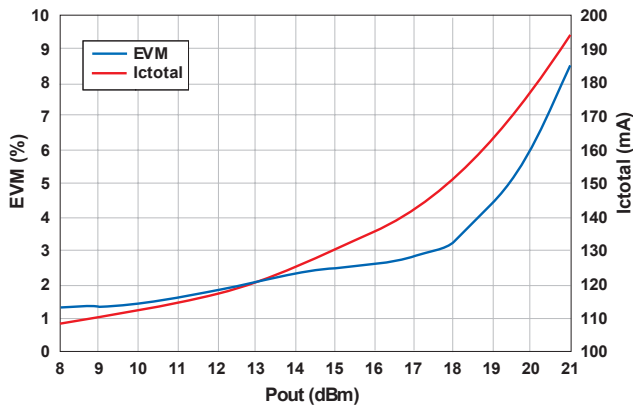
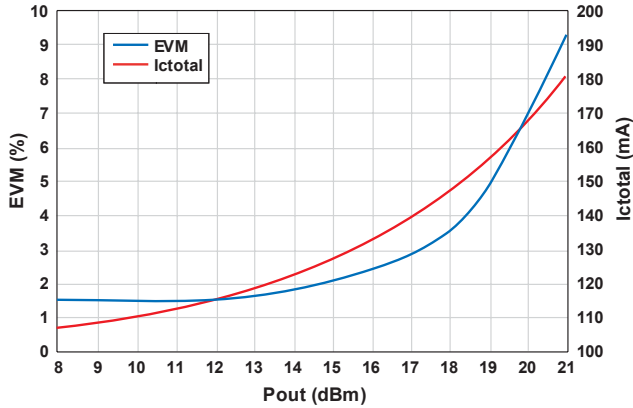

Notes: All EVM data are for OFDM signal of 64QAM/54Mbps and are actual measured data without any de-embedding. Source EVM from is around 1.4~1.8% for the input power levels for test.

CHARACTERISTIC CURVES

Typical Power Sweep Data at Room Temperature

(Vc=3.3V, Icq=100mA)

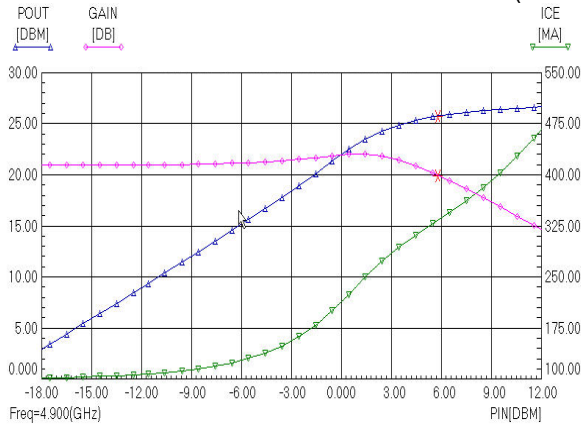

Freq=4.97GHz

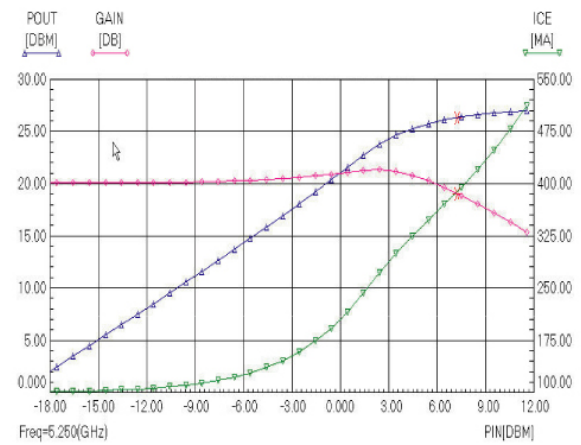

Freq=5.25GHz

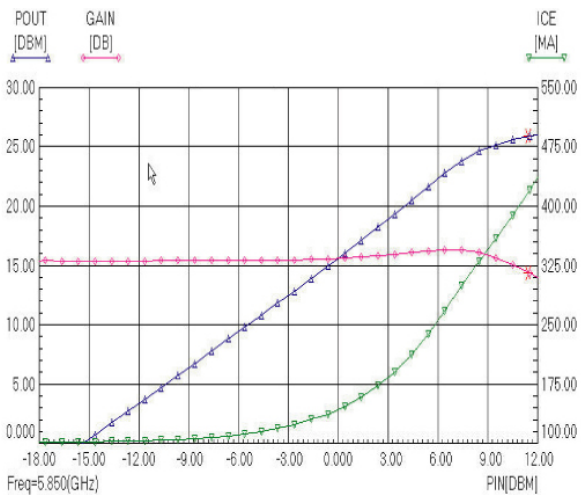

Freq=5.85GHz

CHARACTERISTIC CURVES

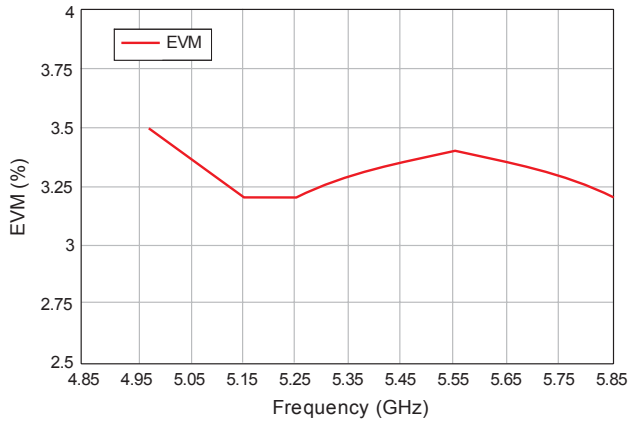
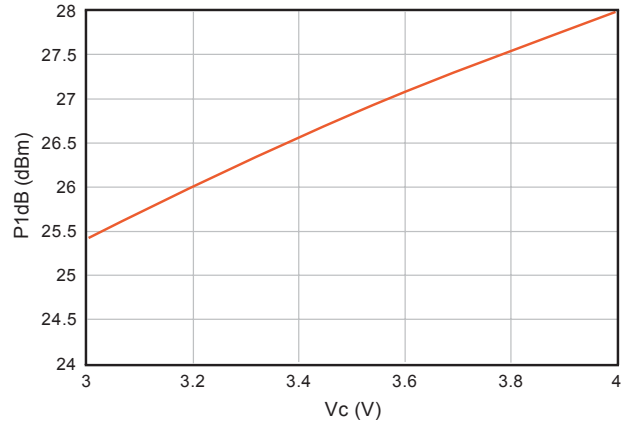
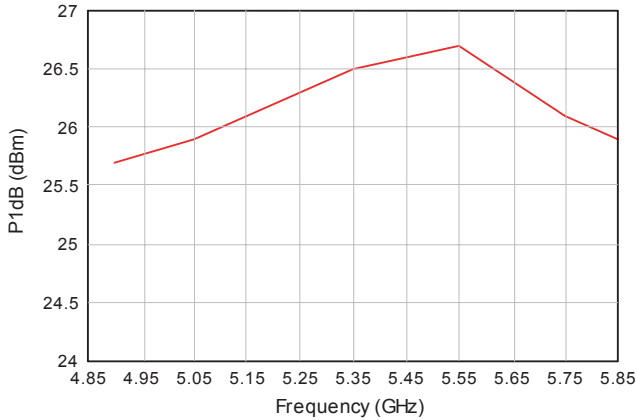
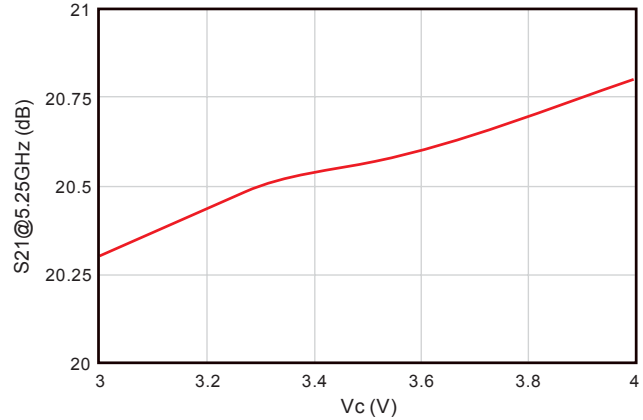
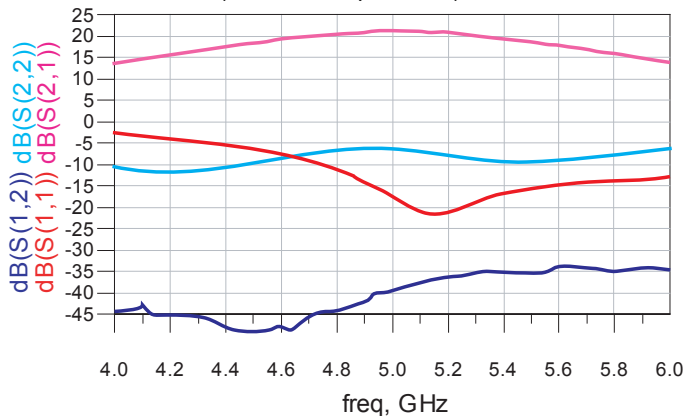
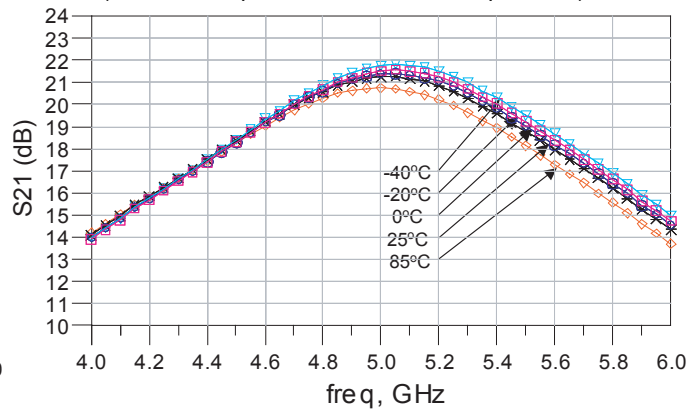
 Typical EVM vs. Frequency
 (Vc=3.3V, Icq=100mA, Pout=18dBm, 64QAM/54Mbps)

 Typical P1dB vs. Supply Voltage
 (Vc=3.3V, Icq=100mA, Freq=5.25GHz)

 Typical P1dB vs. Frequency
 (Vc=3.3V, Icq=100mA)

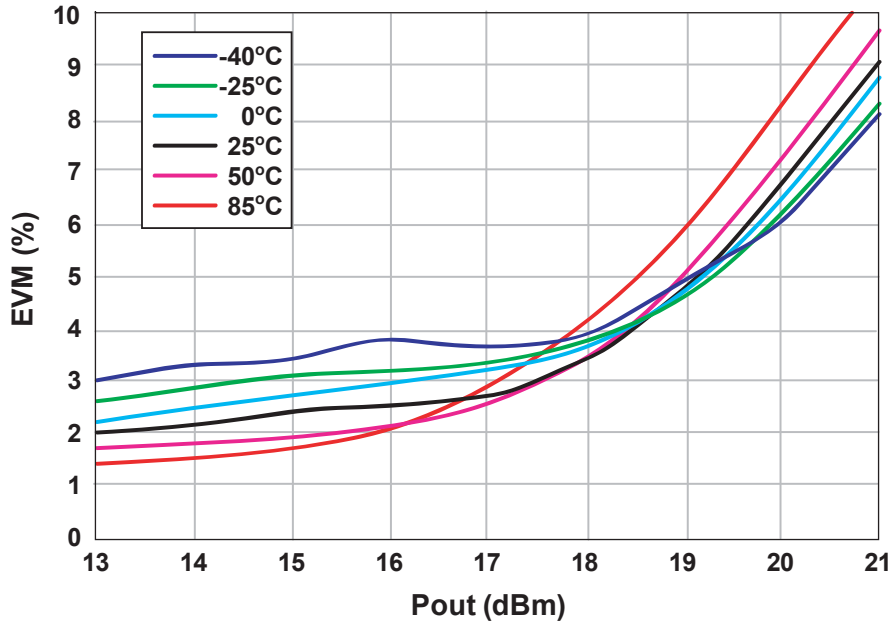
 Typical Small-Signal Gain vs. Supply Voltage
 (Vc=3.3V, Icq=100mA, Freq=5.25GHz)

 Typical S-Parameter Data at Room Temperature
 (Vc=3.3V, Icq=100mA)

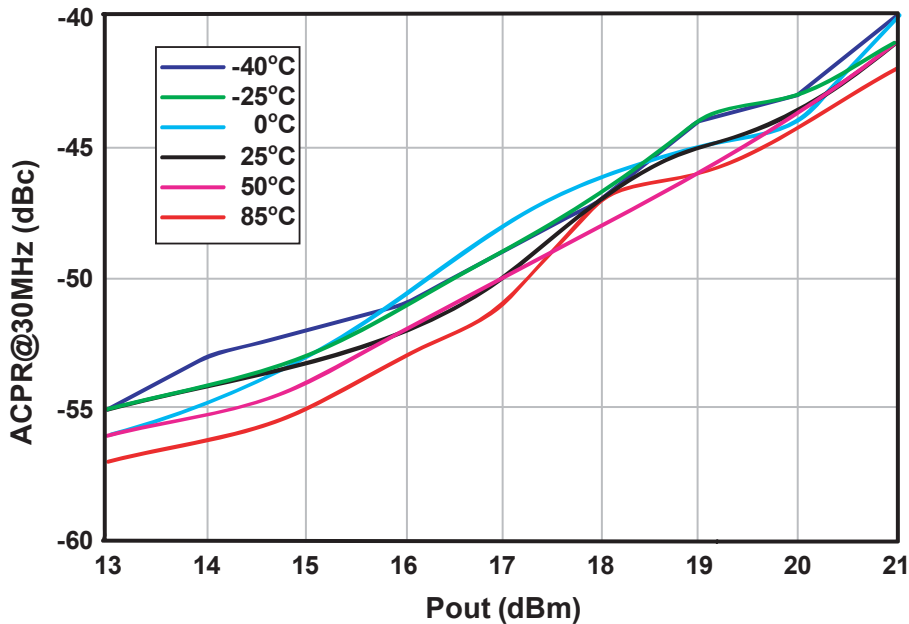
 Typical Small-Signal Gain Variation Over Temperature
 (Vc=3.3V, Icq=100mA at Room Temperature)

CHARACTERISTIC CURVES

Typical EVM Variation Over Temperature
($V_c=3.3V$, $I_{cQ}=100mA$ at Room Temperature, $P_{out}=18dBm$, $Freq=5.25GHz$)



Typical ACPR Variation Over Temperature
($V_c=3.3V$, $I_{cQ}=100mA$ at Room Temperature, $P_{out}=18dBm$, $Freq=5.25GHz$)

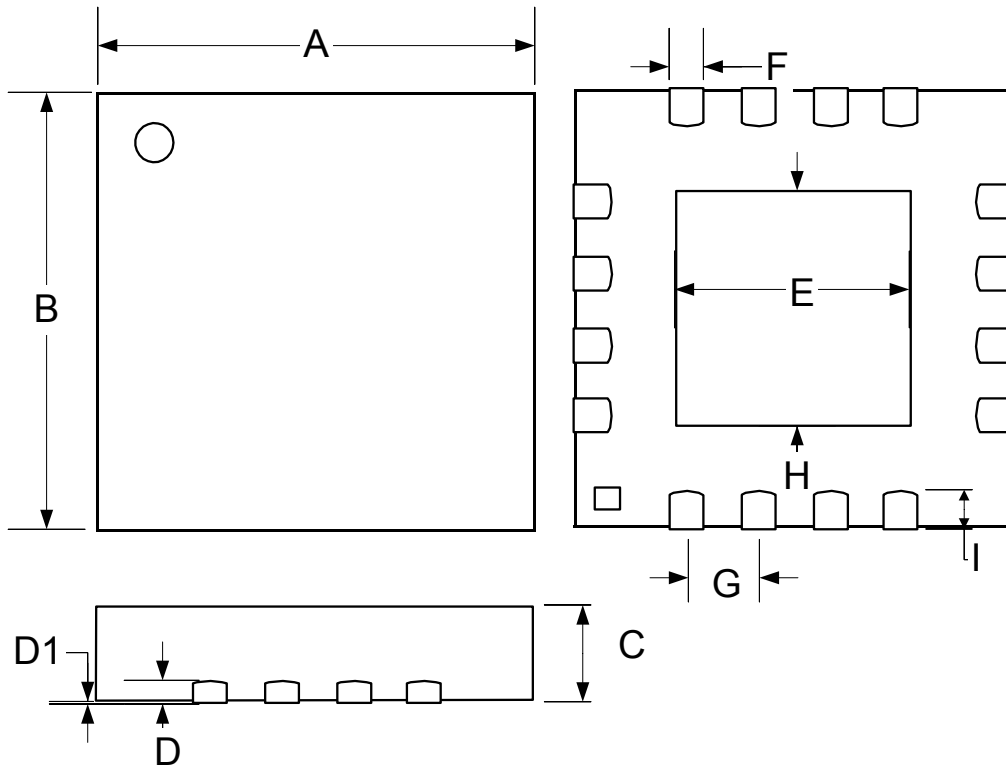

PACKAGE DIMENSIONS
LQ 16-Pin MLPQ Plastic (3x3mm² EP)

Dim	MILLIMETERS		INCHES	
	MIN	MAX	MIN	MAX
A	3.00 BSC		0.118 BSC	
B	3.00 BSC		0.118 BSC	
C	0.80	1.00	0.031	0.039
D	0.18	0.30	0.007	0.011
D1	0	0.05	0	0.002
E	1.30	1.55	0.051	0.061
F	0.18	0.30	0.007	0.011
G	0.50 BSC		0.019 BSC	
H	1.30	1.55	0.051	0.061
I	0.30	0.50	0.011	0.020

Note:

1. Dimensions do not include mold flash or protrusions; these shall not exceed 0.155mm(.006") on any side. Lead dimension shall not include solder coverage.

NOTES

PRODUCTION DATA – Information contained in this document is proprietary to Microsemi and is current as of application date. This document may not be modified in any way without the express written consent of Microsemi. Product processing does not necessarily include testing of all parameters. Microsemi reserves the right to change the configuration and performance of the product and to discontinue product at any time.