

# IR Receiver Module

## RPM7200-Hx series

RPM7200-Hx series are remote control receiver module. Small-sized, light-weight, and low voltage operated (from 2.7V) modules have been achieved by using resin mold.

### ●Applications

All household electric appliances such as TV, DVD, air conditioner and audio equipment.

### ●Features

- 1) Low voltage operation. ( $V_{CC}=2.7\sim 3.6V$ )
- 2) Low current consumption. ( $I_{CC}=0.3mA$ ,  $V_{CC}=3V$ )
- 3) Superior anti  $V_{CC}$  noise characteristics.
- 4) 5 types of holders available to each set.

### ●RPM7200 series

Center frequency	TOP VIEW			SIDE VIEW	
	RSIP-A3 (H4)	RSIP-A3 (H8)	RSIP-A3 (H9)	RSIP-A3 (H3)	RSIP-A3 (H5)
Height to lens	15.9mm	7.2mm	12.0mm	19.0mm	9.6mm
36.7kHz	RPM7237-H4	RPM7237-H8	RPM7237-H9	RPM7237-H3	RPM7237-H5
37.9kHz	RPM7238-H4	RPM7238-H8	RPM7238-H9	RPM7238-H3	RPM7238-H5
40.0kHz	RPM7240-H4	RPM7240-H8	RPM7240-H9	RPM7240-H3	RPM7240-H5

### ●Absolute maximum ratings ( $T_a = 25^\circ C$ )

Parameter	Symbol	Limits	Unit
Supply Voltage	$V_{CC}$	6.3	V
Output current	$I_o$	2.0	mA
Storage temperature	$T_{stg}$	$-30\sim +100$	$^\circ C$

### ●Recommended operating conditions ( $T_a = 25^\circ C$ )

Parameter	Symbol	Min.	Typ.	Max.	Unit
Supply voltage	$V_{CC}$	2.7	3.0	3.6	V
Operating temperature voltage	$T_{opr}$	$-10$	25	75	$^\circ C$

Photo Link Module

●Block diagram

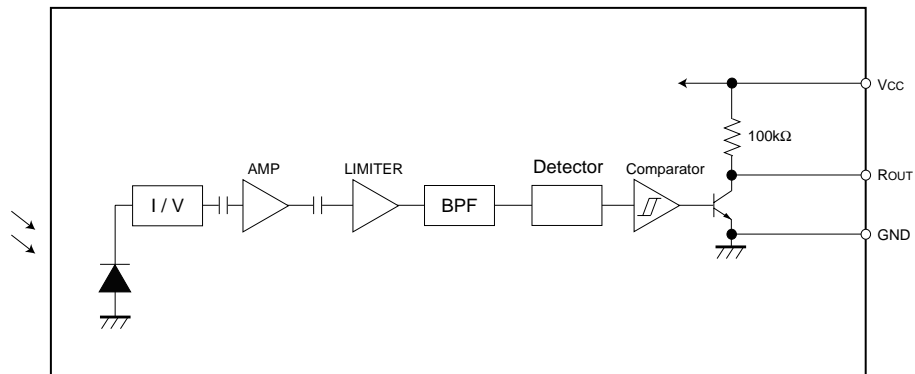

●Terminal description

Pin No.	Pin name	Function
1	V <sub>OUT</sub>	OUTPUT TERMINAL
2	GND	GROUND
3	V <sub>CC</sub>	POWER SUPPLY



●Electrical, Optical characteristics (Unless otherwise noted, Ta = 25°C V<sub>CC</sub>=3V)

Parameter	Symbol	Min.	Typ.	Max.	Unit	Conditions
Consumption Current	I <sub>CC</sub>	–	300	500	μA	No outside light, No signal input
Effective Distance	L	8	15	–	m	Outer light condition E <sub>e</sub> < 10 (lx) *1
High Level Output Voltage	V <sub>H</sub>	2.5	–	–	V	*1
Low Level Output Voltage	V <sub>L</sub>	–	–	0.5	V	I <sub>sink</sub> ≤ 200μA *1
ON Pulse Width	T <sub>ON</sub>	400	600	800	μs	Outer light condition E <sub>e</sub> < 10 (lx) *1
OFF Pulse Width	T <sub>OFF</sub>	400	600	800	μs	Outer light condition E <sub>e</sub> < 10 (lx) *1
Center frequency	f <sub>o</sub>	–	*3	–	kHz	
Horizontal half angle	θ 1/2	–	45	–	deg	*2
Vertical half angle	θ 1/2	–	35	–	deg	*2

\*1 600/600μs burst wave is transmitted by standard transmitter. However, it must be measured after the initial transmission pulse is 10 pulse.

\*2 It is an angle when the linear arrival distance become half.

\*3 Three types of frequencies : 36.7, 37.9, 40kHz.

● Measurement Conditions

(1) Transmit signal

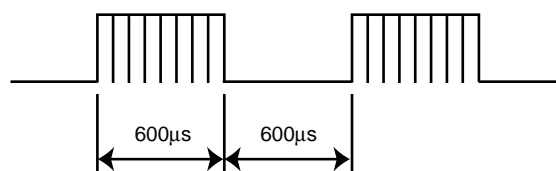

Carrier frequency=f<sub>o</sub>, Duty=50%

Fig.1 Transmit signal

Photo Link Module

(2) Standard transmitter

$\lambda_{peak}=940nm$   
 $\Delta\lambda=40nm$

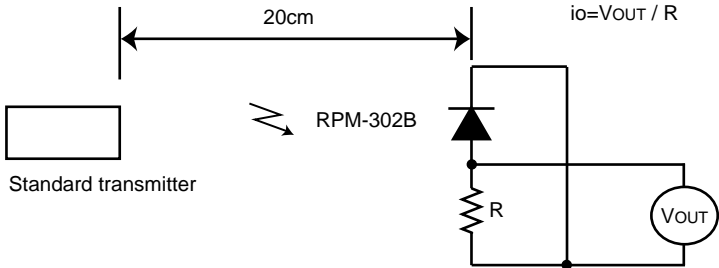

Fig.2 Measurement of standard transmitter proofreading

When standard transmitter output the signal at Fig.1 standard photodiode output become  $i_o=5\mu A_{p-p}$  under the measurement condition Fig.2.

(The radiant intensity of standard transmitter :  $50mW / sr$ )

RPM-302B : standard photodiode has short current  $I_{sc}=27\mu A$  at  $E_e=1000(lx)$   
(using CIE standard light source A)

(3) Measurement effective distance, horizontal & vertical half angle

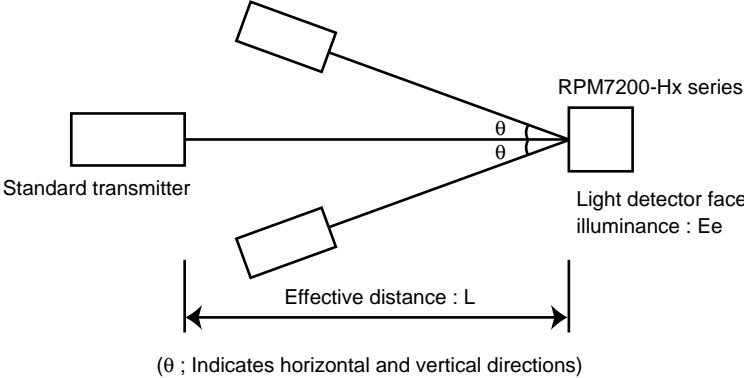

Fig.3 Measurement condition for effective distance

Effective distance L : Effective distance at  $\theta=0^\circ$  Fig.3  
Horizontal & vertical half angle  $\theta$  : The angle which effective distance became 50% of L.

## Photo Link Module

## (4) Output signal

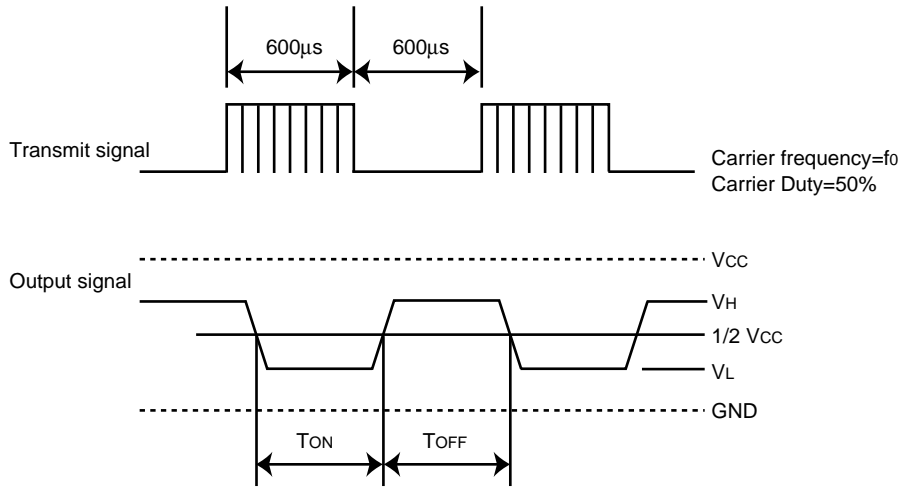

Fig.4

## (5) Measurement circuit for the output voltage and the consumption current

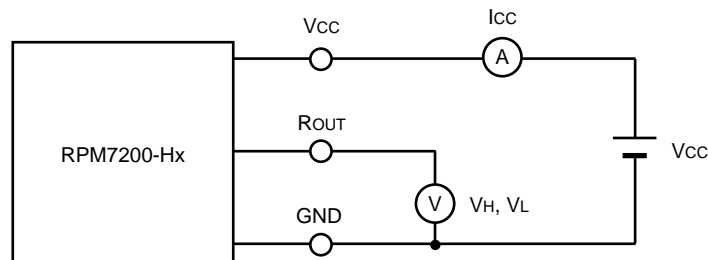
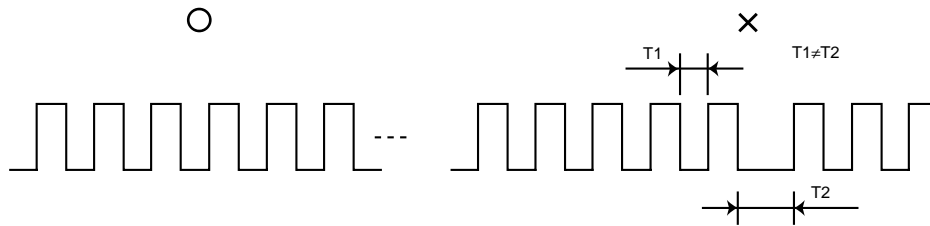

Fig.5

## ●Notes

- (1) All characteristics of the receiver in this specification are specified by supplying burst wave form (Fig.1) with ROHM standard transmitter (Fig.2).  
If in case of other burst wave form will be used, please check these spec. Carefully under the evaluations.
- (2) When the receiver will be used as the wire-less remote controller, please use the signal method the signal format which refer to "Measures to prevent malfunctioning of IR remote-controlled electric home appliances". (Published July 1987 by Association of Electric Home Appliances)  
If using other signal method, signal format, (ex: signal format which not including the leader signal) the receiver might have chances to miss-function.
- (3) Please set up transmitter's carrier frequency as same as the receiver's  $f_0$  frequency. Otherwise error might be occurred.
- (4) If transmission signal has non-continues carrier, error might be occurred. Continuous carrier is necessary.

## Photo Link Module



- (5) The receiver was designed to use as in-door use only.  
Therefore, please understand that the receiver cannot cover all characteristics, in case of using it out-door.
- (6) Noise environment (Light noise from inverter Lamp, and other kind of Lamps, Power ripple, electromagnetic noise from power circuit, and etc) may cause a reduced effective distance.
- (7) The receiver may not work properly if receiving signal judgement is done by single pulse due to the surrounding / environmental noises.  
To prevent such misjudgement, please make sure that the receiver is set up to work only when receiving series of coded signal.
- (8) Emitting unit (remote control transmitter) has to be considered about its emitting device function, characteristics and characteristics of the receiver.
- (9) Please connect 'Holder' on to the 'Ground (GND)' of PCB. If the holder is not connected to the GND, there is a possibility of worsening the characteristics of product.
- (10) Do not supply unnecessary stress to lead and holder.
- (11) Please pay careful attention to the lens.  
It might have a chance to miss-function when the lens get dust or dirty. And also please do not touch the lens.
- (12) In order to prevent products from ESD, human body and solder iron, etc. are required to be grounded.

Photo Link Module

●External dimensions (Units : mm)

