

Choke Coils

Series: **Pin terminal**
 Type: **06D, 09D, 10D, 12D, 16B, 18B**
10E, 12E, 15E, 18E

Japan
 Singapore
 Indonesia



Pin terminal inductors featuring small size and high performance

Industrial Property: Patents 1 (pending)



■ Features

- Adoption of High μ and High B_m ferrite cores
- Wide inductor range
- Magnetic shield type (E Type)

■ Recommended Applications

- CTV, VTR, Audio, PC, Facsimiles



■ Explanation of Part Numbers

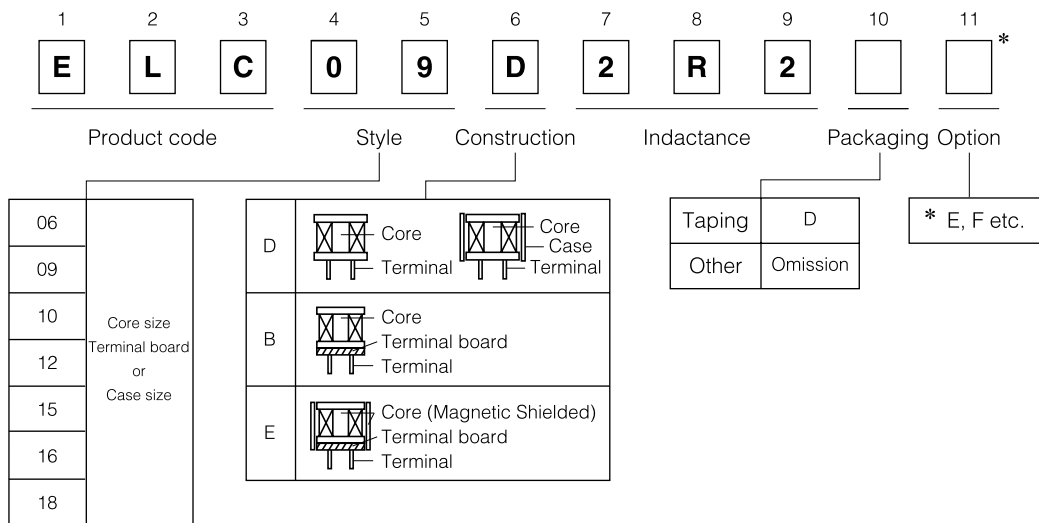

■ Available I-L Characteristics

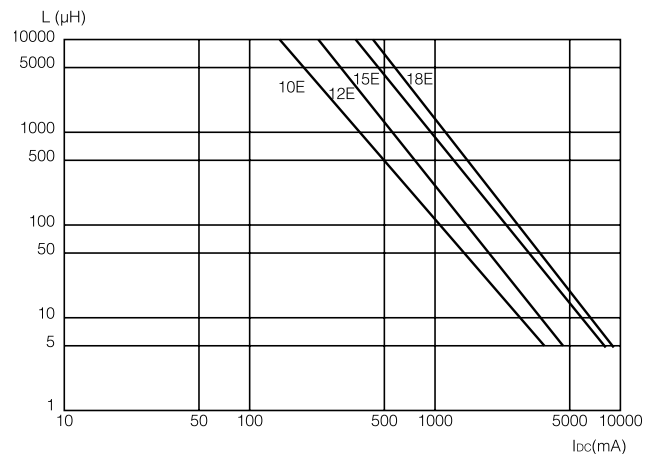
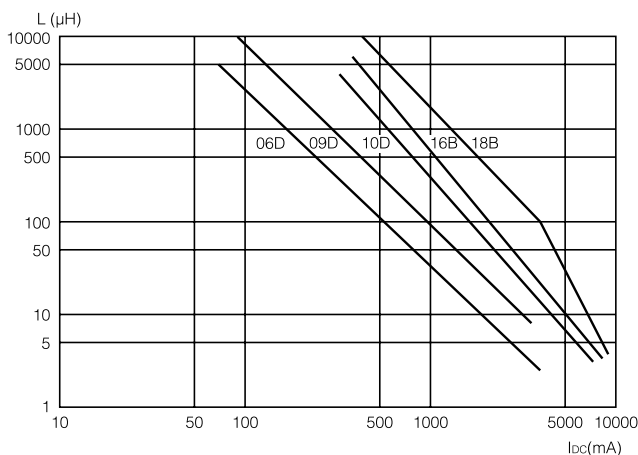

Examples Type 06D

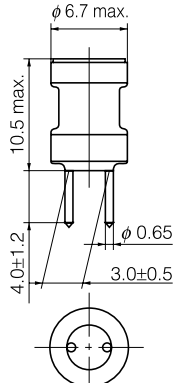
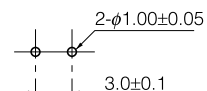
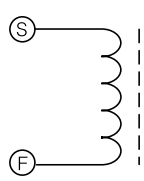
| | Part No. | Inductance (μH) | Tolerance (%) | Test Freq. (kHz) | DCR.(Ω) [at 20 °C] **(Tol.±30 %) (Tol.±20 %) | *IDC. [at 20 °C] (A)max. |
|--|------------|-----------------|---------------|------------------|---|--------------------------------|
| <p>[Dimensions in mm] (not to scale)</p>  | ELC06D2R2E | 2.2 | ±20 | 10 | **0.026 | 3.400 |
| | ELC06D2R7E | 2.7 | | | **0.028 | 3.200 |
| | ELC06D3R3E | 3.3 | | | **0.027 | 3.000 |
| | ELC06D3R9E | 3.9 | | | **0.030 | 2.800 |
| | ELC06D4R7E | 4.7 | | | **0.033 | 2.600 |
| | ELC06D5R6E | 5.6 | | | **0.035 | 2.400 |
| | ELC06D6R8E | 6.8 | | | 0.041 | 2.000 |
| | ELC06D8R2E | 8.2 | | | 0.048 | 1.800 |
| | ELC06D100E | 10.0 | | | 0.052 | 1.700 |
| | ELC06D120E | 12.0 | | | 0.054 | 1.650 |
| | ELC06D150E | 15.0 | | | 0.059 | 1.500 |
| | ELC06D180E | 18.0 | | | 0.065 | 1.250 |
| <p>Recommended PWB piercing plan</p>  | ELC06D220E | 22.0 | ±10 | 10 | 0.076 | 1.200 |
| | ELC06D270E | 27.0 | | | 0.083 | 0.950 |
| | ELC06D330E | 33.0 | | | 0.100 | 0.900 |
| | ELC06D390E | 39.0 | | | 0.105 | 0.850 |
| | ELC06D470E | 47.0 | | | 0.120 | 0.800 |
| | ELC06D560E | 56.0 | | | 0.140 | 0.750 |
| | ELC06D680E | 68.0 | | | 0.150 | 0.700 |
| | ELC06D820E | 82.0 | | | 0.210 | 0.550 |
| | ELC06D101E | 100.0 | | | 0.230 | 0.500 |
| | ELC06D121E | 120.0 | | | 0.260 | 0.490 |
| | ELC06D151E | 150.0 | | | 0.370 | 0.450 |
| | ELC06D181E | 180.0 | | | 0.420 | 0.400 |
| <p>Connection Schematic</p>  | ELC06D221E | 220.0 | ±10 | 10 | 0.550 | 0.360 |
| | ELC06D271E | 270.0 | | | 0.650 | 0.350 |
| | ELC06D331E | 330.0 | | | 0.740 | 0.300 |
| | ELC06D391E | 390.0 | | | 0.950 | 0.270 |
| | ELC06D471E | 470.0 | | | 1.080 | 0.240 |
| | ELC06D561E | 560.0 | | | 1.220 | 0.220 |
| | ELC06D681E | 680.0 | | | 1.590 | 0.210 |
| | ELC06D821E | 820.0 | | | 1.760 | 0.180 |
| | ELC06D102E | 1000.0 | | | 2.490 | 0.160 |
| | ELC06D122E | 1200.0 | | | 2.760 | 0.150 |
| | ELC06D152E | 1500.0 | | | 3.240 | 0.130 |
| | ELC06D182E | 1800.0 | | | 4.560 | 0.120 |
| ELC06D222E | 2200.0 | 5.180 | 0.110 | | | |
| ELC06D272E | 2700.0 | 6.080 | 0.100 | | | |
| ELC06D332E | 3300.0 | 8.800 | 0.100 | | | |
| ELC06D392E | 3900.0 | 9.470 | 0.080 | | | |
| ELC06D472E | 4700.0 | 10.900 | 0.075 | | | |
| ELC06D562E | 5600.0 | 12.300 | 0.070 | | | |

* Allowable DC Current:Smaller current value either when the inductance of -10 %max. changed, or when the temperature of 45 k max. rised.

Examples Type 09D

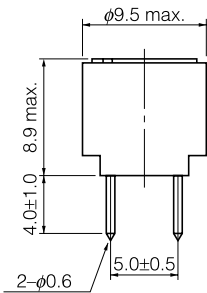
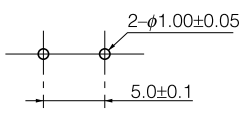
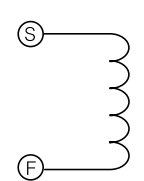
| | Part No. | Inductance (μH) | Tolerance (%) | Test Freq. (kHz) | DCR.(Ω) [at 20 °C] (Tol.±20 %) | *IDC. [at 20 °C] (A)max. |
|--|--|-----------------|---------------|------------------|--------------------------------------|--------------------------------|
| <p>[Dimensions in mm] (not to scale)</p>  | ELC09D2R2□F | 2.2 | ±20 | 10 | 0.012 | 3.50 |
| | ELC09D2R7□F | 2.7 | | | 0.013 | 3.30 |
| | ELC09D3R3□F | 3.3 | | | 0.015 | 3.20 |
| | ELC09D3R9□F | 3.9 | | | 0.016 | 3.10 |
| | ELC09D4R7□F | 4.7 | | | 0.018 | 3.00 |
| | ELC09D5R6□F | 5.6 | | | 0.019 | 2.90 |
| | ELC09D6R8□F | 6.8 | | | 0.021 | 2.80 |
| | ELC09D8R2□F | 8.2 | | | 0.024 | 2.60 |
| | ELC09D100□F | 10.0 | | | 0.027 | 2.50 |
| | ELC09D120□F | 12.0 | | | 0.031 | 2.30 |
| | ELC09D150□F | 15.0 | | | 0.035 | 2.10 |
| | ELC09D180□F | 18.0 | | | 0.038 | 2.00 |
| | ELC09D220□F | 22.0 | | | 0.051 | 1.80 |
| | ELC09D270□F | 27.0 | | | 0.058 | 1.60 |
| | ELC09D330□F | 33.0 | | | 0.081 | 1.40 |
| | ELC09D390□F | 39.0 | | | 0.087 | 1.30 |
| | ELC09D470□F | 47.0 | | | 0.110 | 1.20 |
| | ELC09D560□F | 56.0 | | | 0.130 | 1.10 |
| | ELC09D680□F | 68.0 | | | 0.140 | 1.00 |
| | <p>Recommended PWB piercing plan</p>  | ELC09D820□F | | | 82.0 | ±10 |
| ELC09D101□F | | 100.0 | 0.200 | 0.82 | | |
| ELC09D121□F | | 120.0 | 0.250 | 0.77 | | |
| ELC09D151□F | | 150.0 | 0.320 | 0.74 | | |
| ELC09D181□F | | 180.0 | 0.360 | 0.61 | | |
| ELC09D221□F | | 220.0 | 0.410 | 0.58 | | |
| ELC09D271□F | | 270.0 | 0.500 | 0.52 | | |
| ELC09D331□F | | 330.0 | 0.650 | 0.49 | | |
| ELC09D391□F | | 390.0 | 0.860 | 0.46 | | |
| ELC09D471□F | | 470.0 | 0.980 | 0.39 | | |
| ELC09D561□F | | 560.0 | 1.100 | 0.36 | | |
| ELC09D681□F | | 680.0 | 1.400 | 0.34 | | |
| ELC09D821□F | | 820.0 | 1.600 | 0.30 | | |
| ELC09D102□F | | 1000.0 | 2.100 | 0.28 | | |
| ELC09D122□F | | 1200.0 | 2.400 | 0.23 | | |
| ELC09D152□F | | 1500.0 | 2.800 | 0.21 | | |
| ELC09D182□F | | 1800.0 | 3.800 | 0.19 | | |
| ELC09D222□F | | 2200.0 | 4.400 | 0.17 | | |
| ELC09D272□F | | 2700.0 | 6.100 | 0.16 | | |
| ELC09D332□F | | 3300.0 | 7.000 | 0.14 | | |
| ELC09D392□F | 3900.0 | 8.000 | 0.13 | | | |
| ELC09D472□F | 4700.0 | 11.200 | 0.12 | | | |
| ELC09D562□F | 5600.0 | 12.600 | 0.11 | | | |
| ELC09D682□F | 6800.0 | 14.400 | 0.10 | | | |
| ELC09D822□F | 8200.0 | 16.600 | 0.09 | | | |
| ELC09D103□F | 10000.0 | 18.800 | 0.08 | | | |
| <p>Connection Schematic</p>  | | | | | | |

*Allowable DC Current:Smaller current value either when the inductance of -10 %max. changed, or when the temperaturer of 45k max. rised.

Design and specifications are each subject to change without notice. Ask factory for the current technical specifications before purchase and/or use. Should a safety concern arise regarding this product, please be sure to contact us immediately.

Examples Type 10D

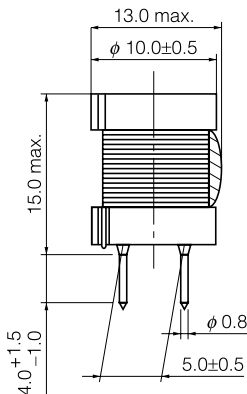
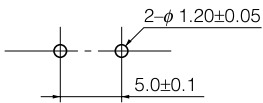
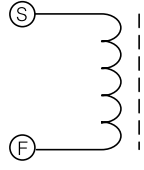
| | Part No. | Inductance (μH) | Tolerance (%) | Test Freq. (kHz) | DCR.(Ω) [at 20°C] (Tol.±20 %) | *IDC. [at 20°C] (A)max. |
|---|------------|-----------------|---------------|------------------|-------------------------------|-------------------------|
| <p>[Dimensions in mm] (not to scale)</p>  <p>Recommended PWB piercing plan</p>  <p>Connection Schematic</p>  | ELC10D2R2E | 2.2 | ±20 | 10 | 0.014 | 5.90 |
| | ELC10D2R7E | 2.7 | | | 0.015 | 5.50 |
| | ELC10D3R3E | 3.3 | | | 0.016 | 5.20 |
| | ELC10D3R9E | 3.9 | | | 0.018 | 4.80 |
| | ELC10D4R7E | 4.7 | | | 0.019 | 4.60 |
| | ELC10D5R6E | 5.6 | | | 0.021 | 4.30 |
| | ELC10D6R8E | 6.8 | | | 0.022 | 4.20 |
| | ELC10D8R2E | 8.2 | | | 0.024 | 4.00 |
| | ELC10D100E | 10.0 | | | 0.026 | 3.90 |
| | ELC10D120E | 12.0 | | | 0.028 | 3.80 |
| | ELC10D150E | 15.0 | | | 0.033 | 3.50 |
| | ELC10D180E | 18.0 | | | 0.036 | 3.40 |
| | ELC10D220E | 22.0 | | | 0.040 | 3.20 |
| | ELC10D270E | 27.0 | | | 0.044 | 3.00 |
| | ELC10D330E | 33.0 | | | 0.051 | 2.80 |
| | ELC10D390E | 39.0 | 0.054 | | 2.70 | |
| | ELC10D470E | 47.0 | 0.060 | | 2.50 | |
| | ELC10D560E | 56.0 | 0.067 | | 2.30 | |
| | ELC10D680E | 68.0 | 0.075 | | 2.10 | |
| | ELC10D820E | 82.0 | 0.095 | | 1.80 | |
| | ELC10D101E | 100.0 | 0.110 | | 1.70 | |
| | ELC10D121E | 120.0 | 0.120 | | 1.60 | |
| | ELC10D151E | 150.0 | 0.160 | | 1.40 | |
| | ELC10D181E | 180.0 | 0.180 | | 1.30 | |
| | ELC10D221E | 220.0 | 0.210 | | 1.10 | |
| | ELC10D271E | 270.0 | 0.280 | | 1.00 | |
| | ELC10D331E | 330.0 | 0.320 | | 0.90 | |
| | ELC10D391E | 390.0 | 0.400 | | 0.80 | |
| | ELC10D471E | 470.0 | 0.450 | | 0.70 | |
| | ELC10D561E | 560.0 | 0.560 | | 0.68 | |
| | ELC10D681E | 680.0 | 0.660 | | 0.64 | |
| | ELC10D821E | 820.0 | 0.800 | | 0.55 | |
| | ELC10D102E | 1000.0 | 1.000 | | 0.50 | |
| ELC10D122E | 1200.0 | 1.200 | 0.45 | | | |
| ELC10D152E | 1500.0 | 1.500 | 0.42 | | | |
| ELC10D182E | 1800.0 | 1.800 | 0.40 | | | |
| ELC10D222E | 2200.0 | 2.100 | 0.36 | | | |
| ELC10D272E | 2700.0 | 2.700 | 0.32 | | | |
| ELC10D332E | 3300.0 | 3.200 | 0.28 | | | |
| ELC10D392E | 3900.0 | 3.500 | 0.26 | | | |

*Allowable DC Current:Smaller current value either when the inductance of -10 %max. changed, or when the temperatuer of 45k max. rised.

Examples Type 12D

| | Part No. | Inductance (μH) | Tolerance (%) | Test Freq. (kHz) | DCR (Ω) [at 20 °C] (Tol. ±20 %) | *IDC. [at 20 °C] (A)max. |
|---|------------|-----------------|---------------|------------------|---------------------------------------|--------------------------------|
| <p>[Dimensions in mm] (not to scale)</p> <p>Recommended PWB piercing plan</p> <p>Connection Schematic</p> | ELC12D101E | 100 | ±10 | 10 | 0.150 | 1.90 |
| | ELC12D121E | 120 | | | 0.170 | 1.78 |
| | ELC12D151E | 150 | | | 0.190 | 1.67 |
| | ELC12D181E | 180 | | | 0.210 | 1.58 |
| | ELC12D221E | 220 | | | 0.230 | 1.55 |
| | ELC12D271E | 270 | | | 0.270 | 1.44 |
| | ELC12D331E | 330 | | | 0.300 | 1.34 |
| | ELC12D391E | 390 | | | 0.330 | 1.32 |
| | ELC12D471E | 470 | | | 0.380 | 1.25 |
| | ELC12D561E | 560 | | | 0.420 | 1.15 |
| | ELC12D681E | 680 | | | 0.460 | 0.98 |
| | ELC12D821E | 820 | | | 0.650 | 0.94 |
| | ELC12D102E | 1000 | | | 0.720 | 0.87 |
| | ELC12D122E | 1200 | | | 0.830 | 0.86 |
| | ELC12D152E | 1500 | | | 1.270 | 0.64 |
| | ELC12D182E | 1800 | | | 1.330 | 0.63 |
| | ELC12D222E | 2200 | | | 1.500 | 0.60 |
| | ELC12D272E | 2700 | | | 1.890 | 0.54 |
| | ELC12D332E | 3300 | | | 2.370 | 0.48 |
| | ELC12D392E | 3900 | | | 2.830 | 0.45 |
| ELC12D472E | 4700 | 3.190 | 0.41 | | | |
| ELC12D562E | 5600 | 4.080 | 0.34 | | | |
| ELC12D682E | 6800 | 5.740 | 0.29 | | | |
| ELC12D822E | 8200 | 6.340 | 0.28 | | | |
| ELC12D103E | 10000 | 7.200 | 0.27 | | | |

*Allowable DC Current: Smaller current value either when the inductance of -10 %max. changed, or when the temperature of 45k max. risen.

Examples Type 16B

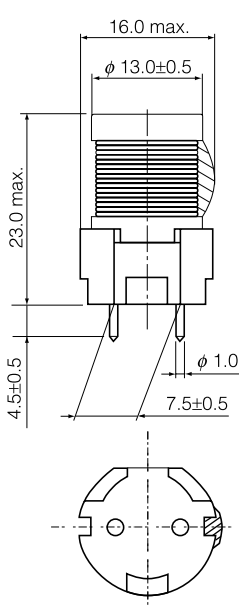
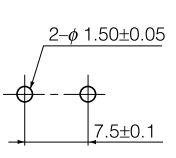
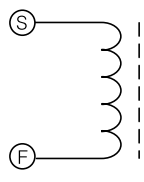
| | Part No. | Inductance (μH) | Tolerance (%) | Test Freq. (kHz) | DCR.(Ω) [at 20°C] **(Tol.±30 %) (Tol.±20 %) | *IDC. [at 20°C] (A)max. |
|--|------------|-----------------|---------------|------------------|--|-------------------------------|
| <p>[Dimensions in mm] (not to scale)</p>  <p>Recommended PWB piercing plan</p>  <p>Connection Schematic</p>  | ELC16B3R3L | 3.3 | ±25 | 10 | **0.012 | 8.50 |
| | ELC16B3R9L | 3.9 | | | **0.013 | 8.00 |
| | ELC16B4R7L | 4.7 | | | **0.015 | 7.80 |
| | ELC16B5R6L | 5.6 | ±20 | | **0.016 | 7.40 |
| | ELC16B6R8L | 6.8 | | | 0.018 | 6.70 |
| | ELC16B8R2L | 8.2 | | | 0.019 | 6.10 |
| | ELC16B100L | 10.0 | | | 0.022 | 5.60 |
| | ELC16B120L | 12.0 | | | 0.023 | 5.50 |
| | ELC16B150L | 15.0 | | | 0.026 | 5.40 |
| | ELC16B180L | 18.0 | | | 0.028 | 5.10 |
| | ELC16B220L | 22.0 | | | 0.031 | 4.60 |
| | ELC16B270L | 27.0 | | | 0.034 | 4.30 |
| | ELC16B330L | 33.0 | | | 0.039 | 4.00 |
| | ELC16B390L | 39.0 | | | 0.042 | 3.90 |
| | ELC16B470L | 47.0 | | | 0.045 | 3.80 |
| | ELC16B560L | 56.0 | 0.051 | | 3.40 | |
| | ELC16B680L | 68.0 | 0.057 | | 3.20 | |
| | ELC16B820L | 82.0 | 0.064 | | 3.00 | |
| | ELC16B101L | 100.0 | 0.072 | | 2.60 | |
| | ELC16B121L | 120.0 | 0.080 | | 2.50 | |
| | ELC16B151L | 150.0 | 0.103 | | 2.20 | |
| | ELC16B181L | 180.0 | 0.115 | | 2.10 | |
| | ELC16B221L | 220.0 | 0.130 | | 1.90 | |
| | ELC16B271L | 270.0 | 0.170 | | 1.60 | |
| | ELC16B331L | 330.0 | 0.200 | | 1.50 | |
| | ELC16B391L | 390.0 | 0.250 | | 1.30 | |
| | ELC16B471L | 470.0 | 0.280 | | 1.20 | |
| | ELC16B561L | 560.0 | 0.380 | | 1.10 | |
| | ELC16B681L | 680.0 | 0.430 | | 1.00 | |
| | ELC16B821L | 820.0 | 0.580 | | 0.88 | |
| | ELC16B102L | 1000.0 | 0.660 | | 0.85 | |
| | ELC16B122L | 1200.0 | 0.740 | | 0.82 | |
| | ELC16B152L | 1500.0 | 0.870 | | 0.74 | |
| ELC16B182L | 1800.0 | 1.220 | 0.60 | | | |
| ELC16B222L | 2200.0 | 1.380 | 0.57 | | | |
| ELC16B272L | 2700.0 | 1.570 | 0.54 | | | |
| ELC16B332L | 3300.0 | 2.000 | 0.47 | | | |
| ELC16B392L | 3900.0 | 2.400 | 0.42 | | | |
| ELC16B472L | 4700.0 | 3.300 | 0.36 | | | |
| ELC16B562L | 5600.0 | 3.700 | 0.34 | | | |
| ELC16B682L | 6800.0 | 4.200 | 0.32 | | | |
| ELC16B822L | 8200.0 | 5.600 | 0.28 | | | |
| ELC16B103L | 10000.0 | 6.400 | 0.26 | | | |
| ELC16B123L | 12000.0 | 7.300 | 0.24 | | | |

*Refer to former page

Examples Type 18B

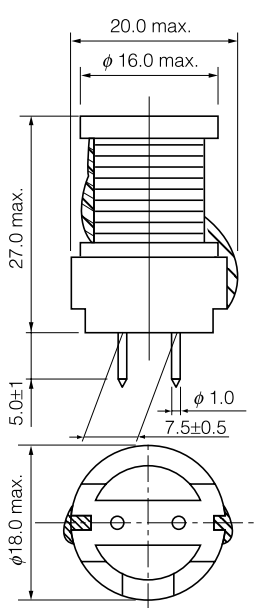
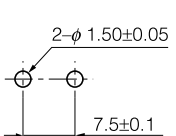
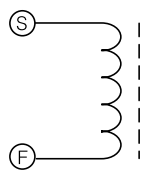
| | Part No. | Inductance (μH) | Tolerance (%) | Test Freq. (kHz) | DCR.(Ω) [at 20°C] (Tol.±20 %) | *IDC. [at 20°C] (A)max. |
|--|------------|-----------------|---------------|------------------|-------------------------------|-------------------------|
| <p>[Dimensions in mm] (not to scale)</p>  <p>Recommended PWB piercing plan</p>  <p>Connection Schematic</p>  | ELC18B3R3L | 3.3 | ±20 | 10 | 0.010 | 8.50 |
| | ELC18B3R9L | 3.9 | | | 0.011 | 8.00 |
| | ELC18B4R7L | 4.7 | | | 0.012 | 7.80 |
| | ELC18B5R6L | 5.6 | | | 0.013 | 7.40 |
| | ELC18B6R8L | 6.8 | | | 0.015 | 6.80 |
| | ELC18B8R2L | 8.2 | | | 0.016 | 6.60 |
| | ELC18B100L | 10.0 | | | 0.017 | 6.50 |
| | ELC18B120L | 12.0 | | | 0.018 | 6.00 |
| | ELC18B150L | 15.0 | | | 0.021 | 5.90 |
| | ELC18B180L | 18.0 | | | 0.022 | 5.60 |
| | ELC18B220L | 22.0 | 0.025 | | 5.40 | |
| | ELC18B270L | 27.0 | 0.028 | | 4.80 | |
| | ELC18B330L | 33.0 | 0.030 | | 4.60 | |
| | ELC18B390L | 39.0 | 0.033 | | 4.40 | |
| | ELC18B470L | 47.0 | 0.037 | | 4.30 | |
| | ELC18B560L | 56.0 | 0.040 | | 4.20 | |
| | ELC18B680L | 68.0 | 0.046 | | 4.00 | |
| | ELC18B820L | 82.0 | 0.051 | | 3.70 | |
| | ELC18B101L | 100.0 | 0.057 | | 3.20 | |
| | ELC18B121L | 120.0 | 0.065 | | 3.00 | |
| | ELC18B151L | 150.0 | 0.072 | | 2.70 | |
| | ELC18B181L | 180.0 | 0.082 | | 2.60 | |
| | ELC18B221L | 220.0 | 0.090 | | 2.40 | |
| | ELC18B271L | 270.0 | 0.110 | | 2.20 | |
| | ELC18B331L | 330.0 | 0.130 | | 1.90 | |
| | ELC18B391L | 390.0 | 0.150 | | 1.80 | |
| | ELC18B471L | 470.0 | 0.210 | | 1.60 | |
| | ELC18B561L | 560.0 | 0.230 | | 1.50 | |
| | ELC18B681L | 680.0 | 0.260 | | 1.40 | |
| | ELC18B821L | 820.0 | 0.340 | | 1.30 | |
| | ELC18B102L | 1000.0 | 0.390 | | 1.10 | |
| | ELC18B122L | 1200.0 | 0.440 | | 1.00 | |
| | ELC18B152L | 1500.0 | 0.580 | | 0.85 | |
| | ELC18B182L | 1800.0 | 0.650 | | 0.84 | |
| ELC18B222L | 2200.0 | 0.880 | 0.75 | | | |
| ELC18B272L | 2700.0 | 1.200 | 0.68 | | | |
| ELC18B332L | 3300.0 | 1.400 | 0.60 | | | |
| ELC18B392L | 3900.0 | 1.500 | 0.57 | | | |
| ELC18B472L | 4700.0 | 1.700 | 0.55 | | | |
| ELC18B562L | 5600.0 | 2.200 | 0.46 | | | |
| ELC18B682L | 6800.0 | 2.800 | 0.45 | | | |
| ELC18B822L | 8200.0 | 3.100 | 0.41 | | | |
| ELC18B103L | 10000.0 | 3.900 | 0.36 | | | |

*Refer to former page

■ Examples Type 10E□□□L

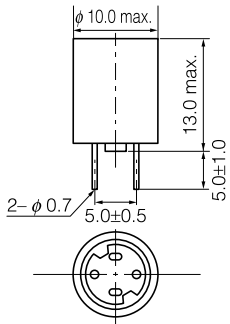
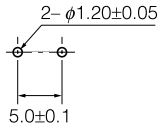
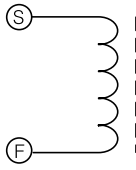
| | Part No. | Inductance (μH) | Tolerance (%) | Test Freq. (kHz) | DCR.(Ω) [at 20°C] (Tol.±20 %) | *IDC. [at 20°C] (A)max. |
|---|---|-----------------|---------------|------------------|-------------------------------|-------------------------|
| [Dimensions in mm] (not to scale)  | ELC10E3R9L | 3.9 | ±20 | 10 | 0.024 | 2.90 |
| | ELC10E4R7L | 4.7 | | | 0.027 | 2.80 |
| | ELC10E5R6L | 5.6 | | | 0.030 | 2.70 |
| | ELC10E6R8L | 6.8 | | | 0.032 | 2.60 |
| | ELC10E8R2L | 8.2 | | | 0.035 | 2.50 |
| | ELC10E100L | 10.0 | | | 0.038 | 2.40 |
| | ELC10E120L | 12.0 | | | 0.040 | 2.30 |
| | ELC10E150L | 15.0 | | | 0.046 | 2.20 |
| | ELC10E180L | 18.0 | | | 0.049 | 2.10 |
| | Recommended PWB piercing plan  | ELC10E220L | | | 22.0 | ±15 |
| ELC10E270L | | 27.0 | 0.062 | 1.90 | | |
| ELC10E330L | | 33.0 | 0.068 | 1.80 | | |
| ELC10E390L | | 39.0 | 0.074 | 1.70 | | |
| ELC10E470L | | 47.0 | 0.098 | 1.50 | | |
| ELC10E560L | | 56.0 | 0.120 | 1.30 | | |
| ELC10E680L | | 68.0 | 0.150 | 1.20 | | |
| ELC10E820L | | 82.0 | 0.190 | 1.00 | | |
| ELC10E101L | | 100.0 | 0.210 | 0.96 | | |
| ELC10E121L | | 120.0 | 0.240 | 0.92 | | |
| Connection Schematic  | ELC10E151L | 150.0 | ±10 | 10 | 0.260 | 0.83 |
| | ELC10E181L | 180.0 | | | 0.290 | 0.74 |
| | ELC10E221L | 220.0 | | | 0.410 | 0.64 |
| | ELC10E271L | 270.0 | | | 0.590 | 0.54 |
| | ELC10E331L | 330.0 | | | 0.660 | 0.52 |
| | ELC10E391L | 390.0 | | | 0.720 | 0.50 |
| | ELC10E471L | 470.0 | | | 0.800 | 0.45 |
| | ELC10E561L | 560.0 | | | 1.100 | 0.41 |
| | ELC10E681L | 680.0 | | | 1.200 | 0.37 |
| | ELC10E821L | 820.0 | | | 1.600 | 0.33 |
| | ELC10E102L | 1000.0 | | | 1.800 | 0.31 |
| | ELC10E122L | 1200.0 | | | 2.000 | 0.29 |
| | ELC10E152L | 1500.0 | | | 2.800 | 0.26 |
| | ELC10E182L | 1800.0 | | | 3.200 | 0.23 |
| | ELC10E222L | 2200.0 | | | 3.600 | 0.20 |
| | ELC10E272L | 2700.0 | | | 5.200 | 0.18 |
| | ELC10E332L | 3300.0 | | | 5.900 | 0.17 |
| | ELC10E392L | 3900.0 | | | 6.500 | 0.16 |
| | ELC10E472L | 4700.0 | | | 9.600 | 0.14 |
| | ELC10E562L | 5600.0 | | | 10.800 | 0.12 |
| | ELC10E682L | 6800.0 | | | 11.900 | 0.11 |
| | ELC10E822L | 8200.0 | | | 13.200 | 0.10 |

*Refer to former page

Examples Type 12E□□□L

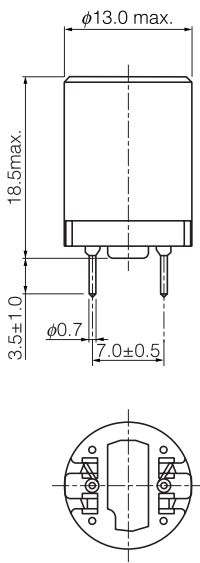
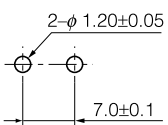
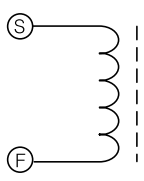
| | Part No. | Inductance (μH) | Tolerance (%) | Test Freq. (kHz) | DCR.(Ω) [at 20°C] (Tol.±20 %) | *IDC. [at 20°C] (A)max. |
|--|------------|-----------------|---------------|------------------|-------------------------------|-------------------------|
| <p>[Dimensions in mm] (not to scale)</p>  <p>Recommended PWB piercing plan</p>  <p>Connection Schematic</p>  | ELC12E4R7L | 4.7 | ±25 | 10 | 0.014 | 4.40 |
| | ELC12E5R6L | 5.6 | | | 0.016 | 4.10 |
| | ELC12E6R8L | 6.8 | | | 0.018 | 3.90 |
| | ELC12E8R2L | 8.2 | ±20 | | 0.020 | 3.70 |
| | ELC12E100L | 10.0 | | | 0.023 | 3.50 |
| | ELC12E120L | 12.0 | | | 0.024 | 3.30 |
| | ELC12E150L | 15.0 | | | 0.028 | 3.20 |
| | ELC12E180L | 18.0 | | | 0.030 | 3.10 |
| | ELC12E220L | 22.0 | | | 0.033 | 2.80 |
| | ELC12E270L | 27.0 | ±10 | | 0.037 | 2.50 |
| | ELC12E330L | 33.0 | | | 0.041 | 2.40 |
| | ELC12E390L | 39.0 | | | 0.044 | 2.20 |
| | ELC12E470L | 47.0 | | | 0.048 | 2.00 |
| | ELC12E560L | 56.0 | | | 0.053 | 1.80 |
| | ELC12E680L | 68.0 | | | 0.073 | 1.70 |
| | ELC12E820L | 82.0 | | | 0.098 | 1.40 |
| | ELC12E101L | 100.0 | | | 0.140 | 1.30 |
| | ELC12E121L | 120.0 | | | 0.160 | 1.20 |
| | ELC12E151L | 150.0 | | | 0.180 | 1.10 |
| | ELC12E181L | 180.0 | | | 0.200 | 1.00 |
| | ELC12E221L | 220.0 | | | 0.220 | 0.91 |
| | ELC12E271L | 270.0 | 0.320 | | 0.83 | |
| | ELC12E331L | 330.0 | 0.360 | | 0.79 | |
| | ELC12E391L | 390.0 | 0.400 | | 0.70 | |
| | ELC12E471L | 470.0 | 0.440 | | 0.64 | |
| | ELC12E561L | 560.0 | 0.490 | | 0.57 | |
| | ELC12E681L | 680.0 | 0.610 | | 0.52 | |
| | ELC12E821L | 820.0 | 0.760 | | 0.47 | |
| | ELC12E102L | 1000.0 | 1.100 | | 0.43 | |
| | ELC12E122L | 1200.0 | 1.200 | | 0.40 | |
| | ELC12E152L | 1500.0 | 1.400 | | 0.36 | |
| | ELC12E182L | 1800.0 | 1.900 | | 0.32 | |
| | ELC12E222L | 2200.0 | 2.500 | | 0.30 | |
| ELC12E272L | 2700.0 | 3.500 | 0.26 | | | |
| ELC12E332L | 3300.0 | 3.900 | 0.24 | | | |
| ELC12E392L | 3900.0 | 4.300 | 0.22 | | | |
| ELC12E472L | 4700.0 | 6.000 | 0.20 | | | |
| ELC12E562L | 5600.0 | 6.600 | 0.17 | | | |
| ELC12E682L | 6800.0 | 9.900 | 0.15 | | | |
| ELC12E822L | 8200.0 | 10.900 | 0.14 | | | |
| ELC12E103L | 10000.0 | 12.200 | 0.13 | | | |

*Refer to former page

Examples Type 15E□□□L

| [Dimensions in mm] (not to scale) | Part No. | Inductance (μH) | Tolerance (%) | Test Freq. (kHz) | DCR.(Ω) [at 20°C] (Tol.±20 %) | *IDC. [at 20°C] (A)max. |
|--------------------------------------|------------|---------------------------------|------------------|---------------------|--|-------------------------------|
| <p>Recommended PWB piercing plan</p> | ELC15E100L | 10 | ±20 | 10 | 0.018 | 5.40 |
| | ELC15E180L | 18 | | | 0.024 | 4.50 |
| | ELC15E330L | 33 | | | 0.032 | 4.00 |
| | ELC15E560L | 56 | ±10 | | 0.039 | 3.60 |
| | ELC15E101L | 100 | | | 0.053 | 3.00 |
| | ELC15E181L | 180 | | | 0.100 | 2.30 |
| | ELC15E331L | 330 | | | 0.170 | 1.60 |
| | ELC15E561L | 560 | | | 0.280 | 1.20 |
| | ELC15E102L | 1000 | | | 0.490 | 0.95 |
| | ELC15E182L | 1800 | | | 0.870 | 0.75 |
| | ELC15E332L | 3300 | | | 1.600 | 0.53 |
| | ELC15E562L | 5600 | | | 2.600 | 0.39 |
| | ELC15E103L | 10000 | | | 4.600 | 0.30 |

*Allowable DC Current: Smaller current value either when the inductance of -10 % max. changed, or when the temperature of 45 k max. risen.

Examples Type 18E□□□L

| [Dimensions in mm] (not to scale) | Part No. | Inductance (μH) | Tolerance (%) | Test Freq. (kHz) | DCR.(Ω) [at 20°C] (Tol.±20 %) | *IDC. [at 20°C] (A)max. |
|--------------------------------------|------------|---------------------------------|------------------|---------------------|--|-------------------------------|
| <p>Recommended PWB piercing plan</p> | ELC18E100L | 10 | ±20 | 10 | 0.014 | 5.90 |
| | ELC18E180L | 18 | | | 0.019 | 5.20 |
| | ELC18E330L | 33 | | | 0.026 | 4.60 |
| | ELC18E560L | 56 | ±10 | | 0.031 | 3.80 |
| | ELC18E101L | 100 | | | 0.044 | 3.00 |
| | ELC18E181L | 180 | | | 0.067 | 2.50 |
| | ELC18E331L | 330 | | | 0.110 | 1.90 |
| | ELC18E561L | 560 | | | 0.170 | 1.40 |
| | ELC18E102L | 1000 | | | 0.280 | 1.00 |
| | ELC18E182L | 1800 | | | 0.570 | 0.80 |
| | ELC18E332L | 3300 | | | 1.000 | 0.60 |
| | ELC18E562L | 5600 | | | 1.600 | 0.46 |
| | ELC18E103L | 10000 | | | 2.700 | 0.33 |

*Allowable DC Current: Smaller current value either when the inductance of -10 % max. changed, or when the temperature of 45 k max. risen.

Tape Dimensions in mm for Type 09D (not to scale)

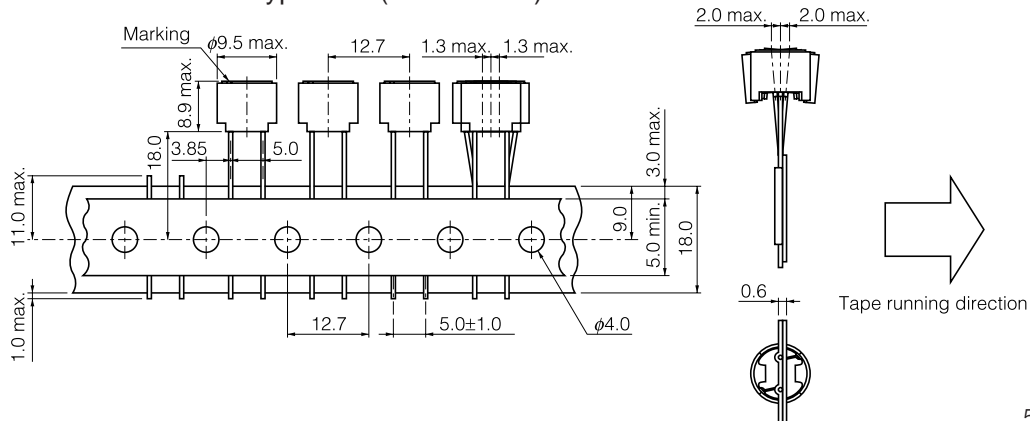

500 pcs./reel