HM6208H Series

65,536-word × 4-bit High Speed CMOS Static RAM

HITACHI

ADE-203-
Rev. 0.0
Dec. 1, 1995

Features

- Single 5 V supply and high density 24-pin package
- High speed: Access time 25/35/45 ns (max)
- Low power
 - Operation: 300 mW (typ)
 - Standby: 100 μ W (typ)
30 μ W (typ) (L-version)
- Completely static memory required
 - No clock or timing strobe required
- Equal access and cycle time
- Directly TTL compatible: All inputs and outputs
- Battery backup operation capability (L-version)

Ordering Information

Type No.	Access Time	Package
HM6208HP-25 HM6208HP-35 HM6208HP-45	25 ns 35 ns 45 ns	300-mil, 24-pin plastic DIP (DP-24NC)
HM6208HLP-25 HM6208HLP-35 HM6208HLP-45	25 ns 35 ns 45 ns	
HM6208HJP-25 HM6208HJP-35 HM6208HJP-45	25 ns 35 ns 45 ns	
HM6208HLJP-25 HM6208HLJP-35 HM6208HLJP-45	25 ns 35 ns 45 ns	

HM6208H Series

Pin Arrangement

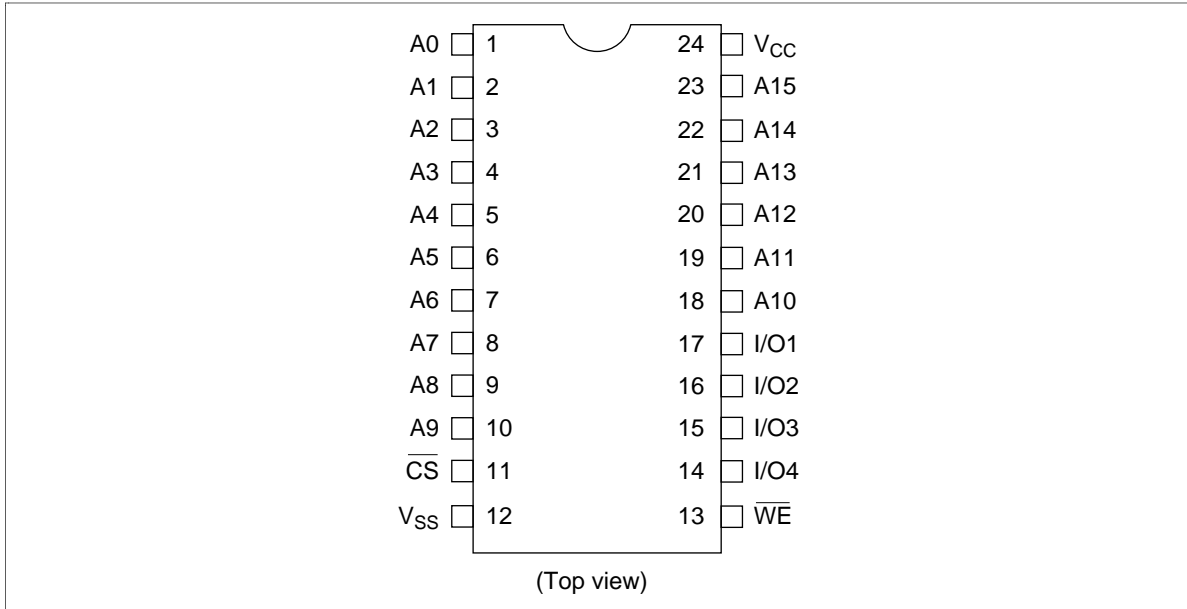

Pin Description

Pin Name	Function
A0–A15	Address
I/O1–I/O4	Input/output
\overline{CS}	Chip select
\overline{WE}	Write enable
V_{CC}	Power supply
V_{SS}	Ground

Block Diagram

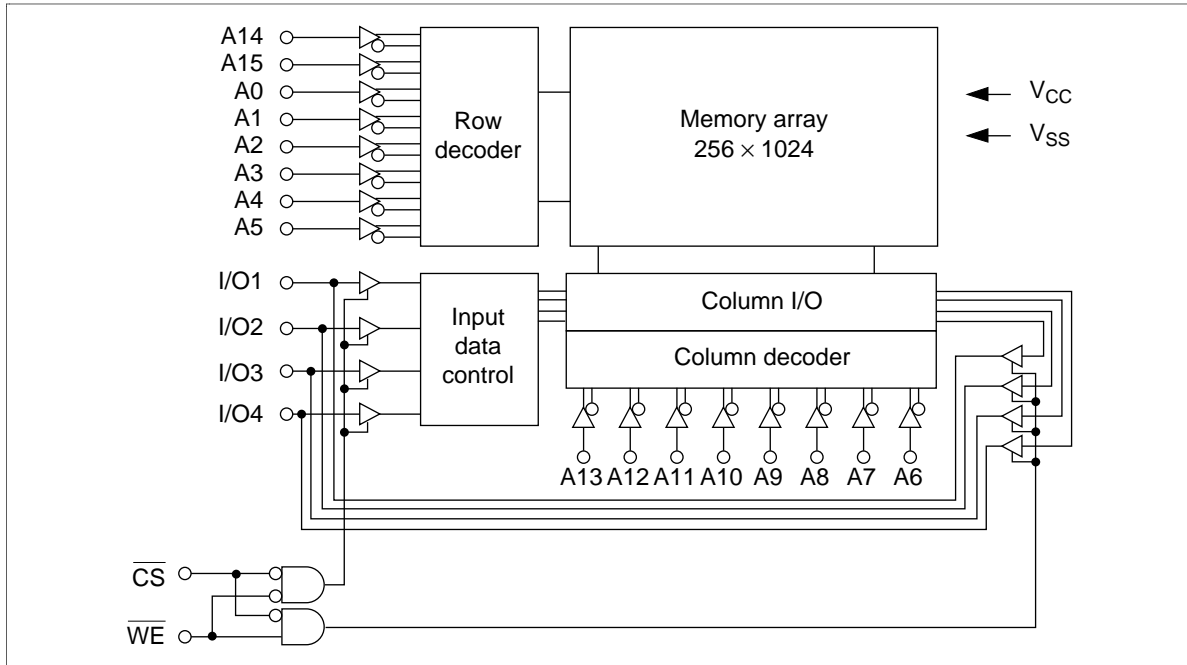

Truth Table

\overline{CS}	\overline{WE}	Mode	V_{CC} Current	I/O Pin	Ref. Cycle
H	x	Not selected	I_{SB}, I_{SB1}	High-Z	—
L	H	Read	I_{CC}	Dout	Read cycle
L	L	Write	I_{CC}	Din	Write cycle

Note: x: Don't care.

Absolute Maximum Ratings

Parameter	Symbol	Value	Unit
Voltage on any pin relative to V_{SS}	V_{in}	-0.5 ¹ to +7.0	V
Power dissipation	P_T	1.0	W
Operating temperature range	T_{opr}	0 to +70	°C
Storage temperature range	T_{stg}	-55 to +125	°C
Storage temperature range under bias	T_{bias}	-10 to +85	°C

Note: 1. $V_{in\ min} = -2.5\ V$ for pulse widths $\leq 10\ ns$.

HM6208H Series

Recommended DC Operating Conditions (Ta = 0 to +70°C)

Parameter	Symbol	Min	Typ	Max	Unit
Supply voltage	V _{CC}	4.5	5.0	5.5	V
	V _{SS}	0	0	0	V
Input high (logic 1) voltage	V _{IH}	2.2	—	6.0	V
Input low (logic 0) voltage	V _{IL}	-0.5 ¹	—	0.8	V

Note: 1. V_{IL} min = -2.0 V for pulse width ≤ 10 ns.

DC Characteristics (Ta = 0 to +70°C, V_{CC} = 5 V ± 10%, V_{SS} = 0 V)

Parameter	Symbol	HM6208H-25			HM6208H-35/45			Unit	Test Conditions
		Min	Typ ²	Max	Min	Typ ²	Max		
Input leakage current	I _{LI}	—	—	2.0	—	—	2.0	μA	V _{CC} = Max V _{in} = V _{SS} to V _{CC}
Output leakage current	I _{LO}	—	—	10.0	—	—	10.0	μA	$\overline{CS} = V_{IH}$, V _{I/O} = V _{SS} to V _{CC}
Operating power supply current	I _{CC}	—	60	120	—	50	100	mA	$\overline{CS} = V_{IL}$, I _{I/O} = 0 mA, min cycle, duty = 100%
	I _{CC1}	—	40	80	—	40	80	mA	$\overline{CS} = V_{IL}$, I _{I/O} = 0 mA, t cycle = 50 ns, duty = 100%
Standby power supply current	ISB	—	20	40	—	15	30	mA	$\overline{CS} = V_{IH}$, min cycle
Standby power supply current (1)	ISB1	—	0.02	2.0	—	0.02	2.0		$\overline{CS} \geq V_{CC} - 0.2$ V, 0 V ≤ V _{in} < 0.2 V, or V _{in} ≥ V _{CC} - 0.2 V
	ISB1 ¹	—	0.006	0.1 ¹	—	0.006	0.1 ¹		
Output low voltage	V _{OL}	—	—	0.4	—	—	0.4	V	I _{OL} = 8 mA
Output high voltage	V _{OH}	2.4	—	—	2.4	—	—	V	I _{OH} = -4.0 mA

Notes: 1. L-version

2. Typical values are at V_{CC} = 5.0 V, Ta = +25°C and not guaranteed.

Capacitance (Ta = 25°C, f = 1 MHz)^{*1}

Parameter	Symbol	Min	Max	Unit	Test Conditions
Input capacitance	C _{in}	—	6	pF	V _{in} = 0 V
Input/output capacitance	C _{I/O}	—	11	pF	V _{I/O} = 0 V

Note: 1. These parameters are sampled and not 100% tested.

AC Characteristics (Ta = 0 to +70°C, V_{CC} = 5 V ± 10%, unless otherwise noted)

Test Conditions

- Input pulse levels: V_{SS} to 3.0 V
- Input rise and fall time: 5 ns
- Input and output timing reference levels: 1.5 V
- Output load: See figure

Output Load

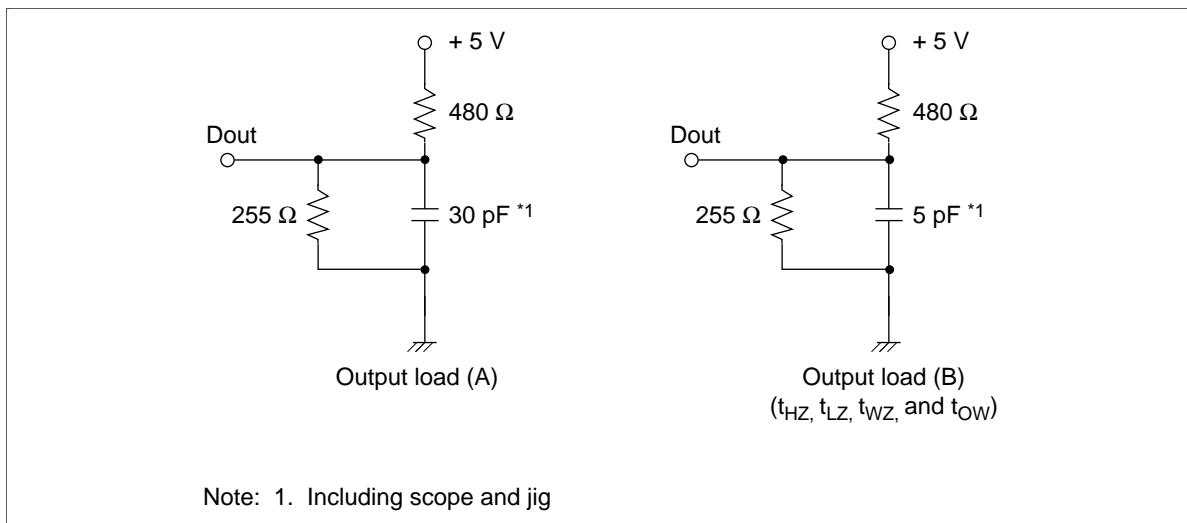

Read Cycle

Parameter	Symbol	HM6208H-25		HM6208H-35		HM6208H-45		Unit
		Min	Max	Min	Max	Min	Max	
Read cycle time	t _{RC}	25	—	35	—	45	—	ns
Address access time	t _{AA}	—	25	—	35	—	45	ns
Chip select access time	t _{ACS}	—	25	—	35	—	45	ns
Output hold from address change	t _{OH}	5	—	5	—	5	—	ns
Chip selection to output in low-Z	t _{LZ} ⁻¹	5	—	5	—	5	—	ns
Chip deselection to output in high-Z	t _{HZ} ⁻¹	0	15	0	20	0	20	ns
Chip selection to power up time	t _{PU}	0	—	0	—	0	—	ns
Chip deselection to power down time	t _{PD}	—	15	—	25	—	30	ns

Note: 1. Transition is measured ±200 mV from steady state voltage with load (B). These parameters are sampled and not 100% tested.

HM6208H Series

Read Timing Waveform (1)

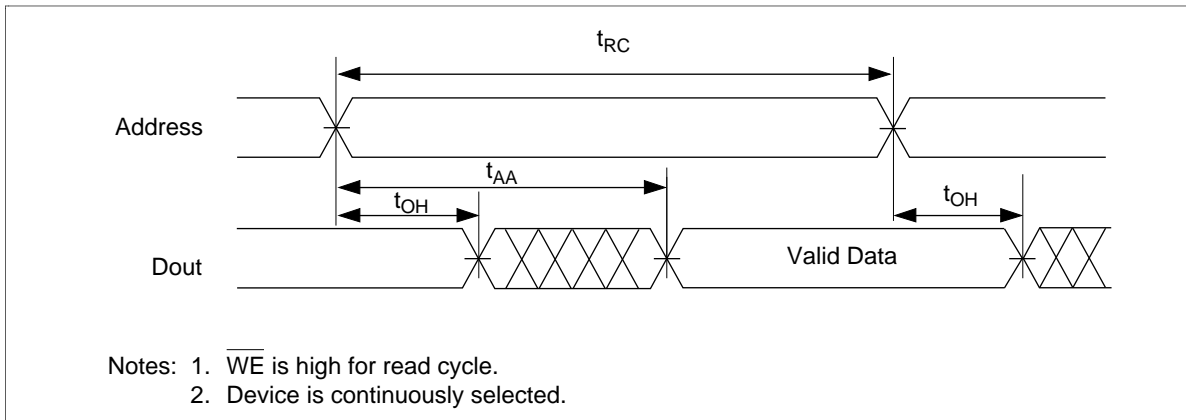

Read Timing Waveform (2)

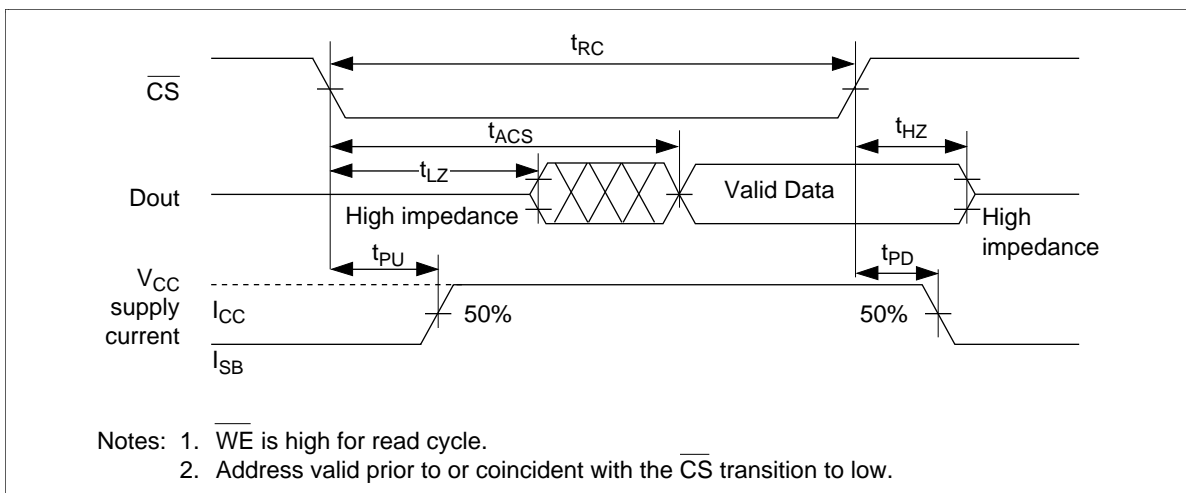

HM6208H Series

Write Cycle

Parameter	Symbol	HM6208H-25		HM6208H-35		HM6208H-45		Unit
		Min	Max	Min	Max	Min	Max	
Write cycle time	t_{WC}	25	—	35	—	45	—	ns
Chip selection to end of write	t_{CW}	20	—	30	—	40	—	ns
Address valid to end of write	t_{AW}	20	—	30	—	40	—	ns
Address setup time	t_{AS}	0	—	0	—	0	—	ns
Write pulse width	t_{WP}	20	—	25	—	30	—	ns
Write recovery time	t_{WR}	3	—	3	—	3	—	ns
Data valid to end of write	t_{DW}	15	—	20	—	20	—	ns
Data hold time	t_{DH}	0	—	0	—	0	—	ns
Write enabled to output in high-Z	t_{WZ}^{*1}	0	8	0	10	0	15	ns
Output active from end of write	t_{OW}^{*1}	0	—	0	—	0	—	ns

Note: 1. Transition is measured ± 200 mV from high impedance voltage with load (B).
 These parameters are sampled and not 100% tested.

HM6208H Series

Write Timing Waveform (1) (\overline{WE} Controlled)

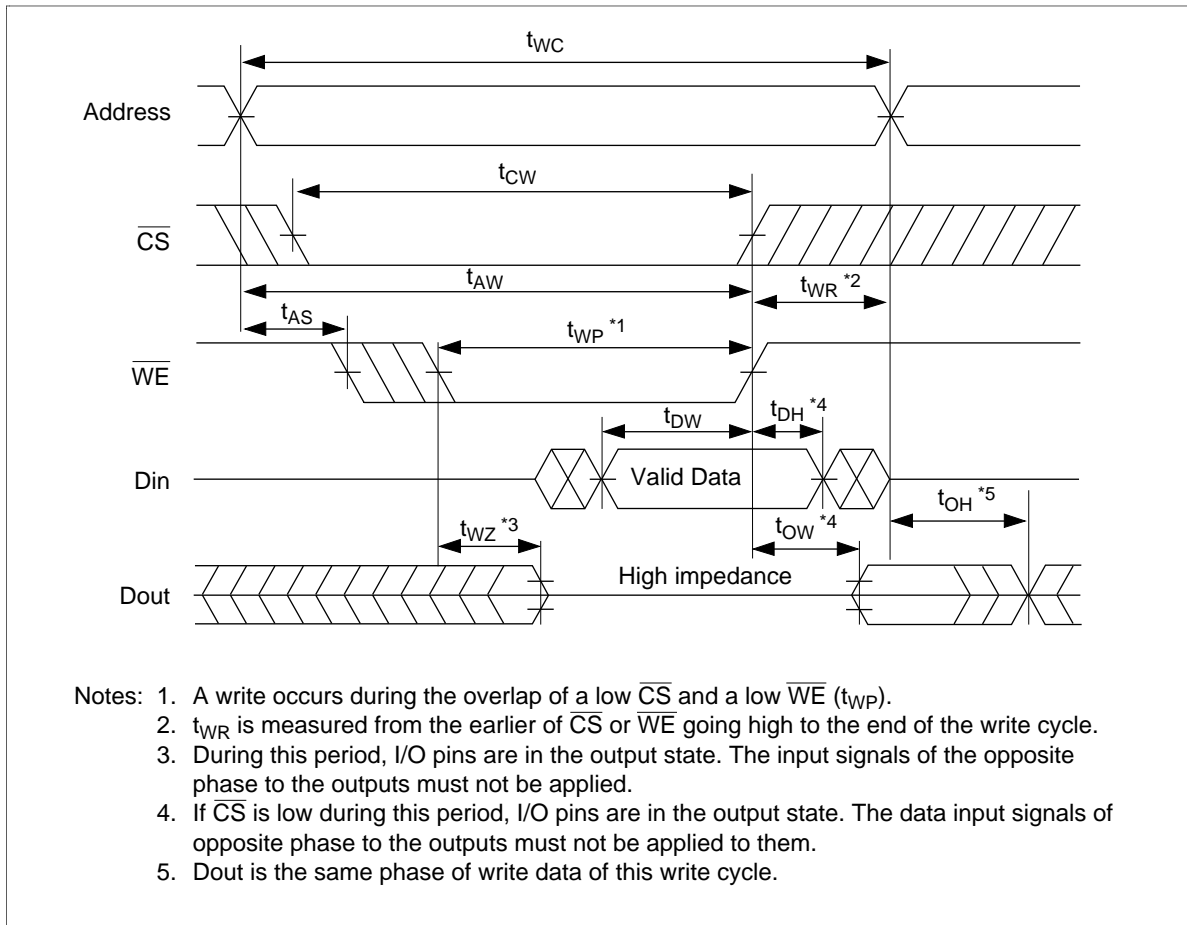

Write Timing Waveform (2) (\overline{CS} Controlled)

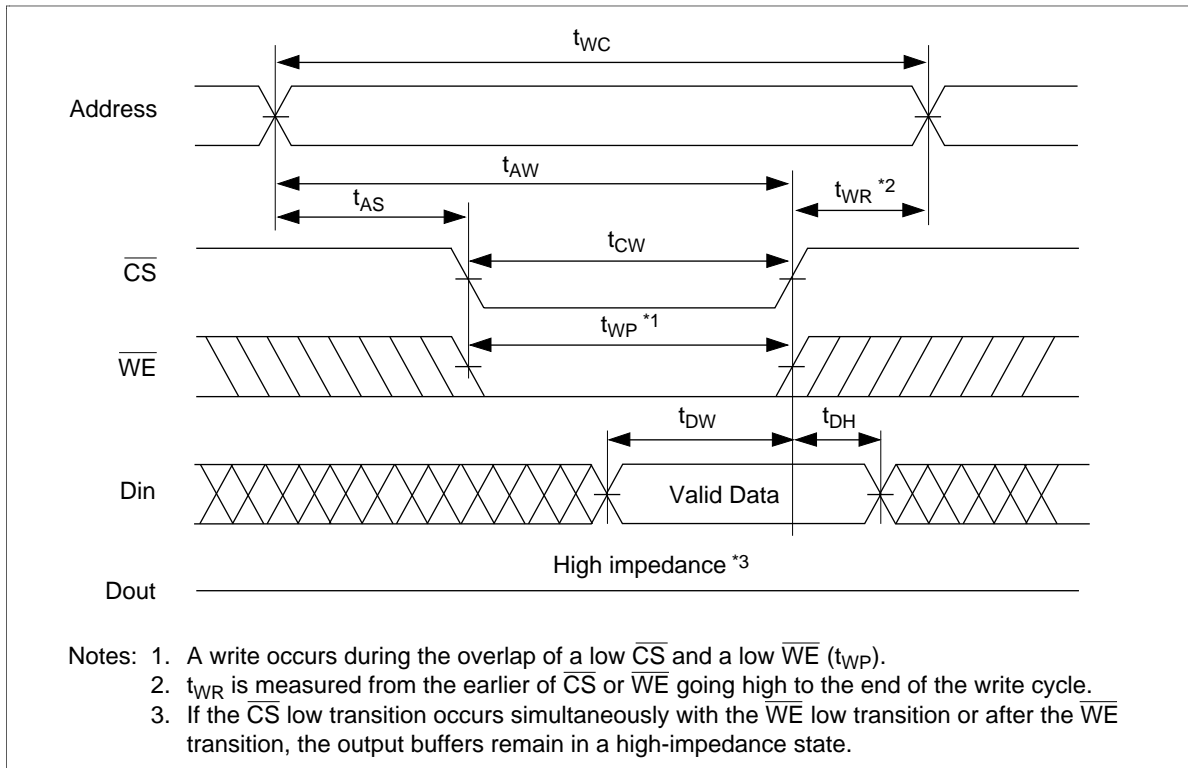

HM6208H Series

Low V_{CC} Data Retention Characteristics ($T_a = 0$ to $+70^\circ\text{C}$)

These characteristics are guaranteed for the L-version only.

Parameter	Symbol	Min	Typ	Max	Unit	Test Conditions
V_{CC} for data retention	V_{DR}	2.0	—	—	V	$\overline{CS} \geq V_{CC} - 0.2 \text{ V}$, $V_{in} \geq V_{CC} - 0.2 \text{ V}$, or $0 \text{ V} \leq V_{in} < 0.2 \text{ V}$, or
Data retention current	I_{CCDR}	—	2	50^{-1}	μA	
Chip deselect to data retention time	t_{CDR}	0	—	—	ns	
Operation recovery time	t_R	5	—	—	ms	

Note: 1. $V_{CC} = 3.0 \text{ V}$

Low V_{CC} Data Retention Timing Waveform

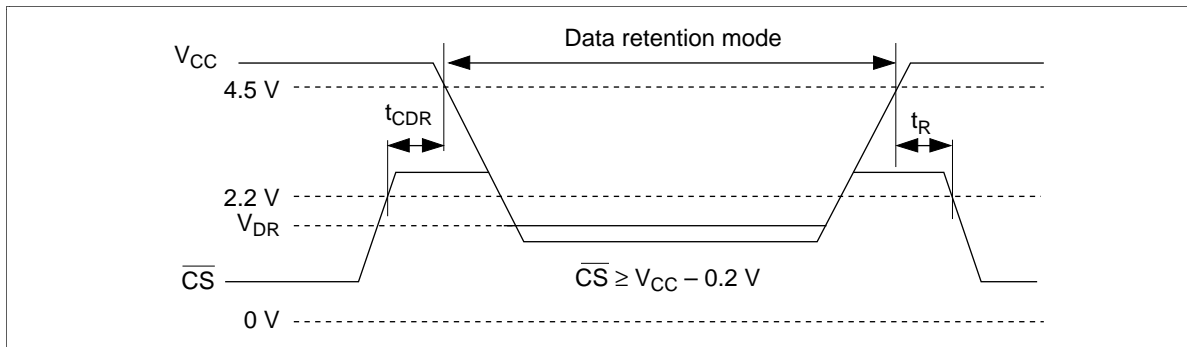

HM6208H Series

Package Dimensions

HM6208HP/HLP Series (DP-24NC)

Unit: mm

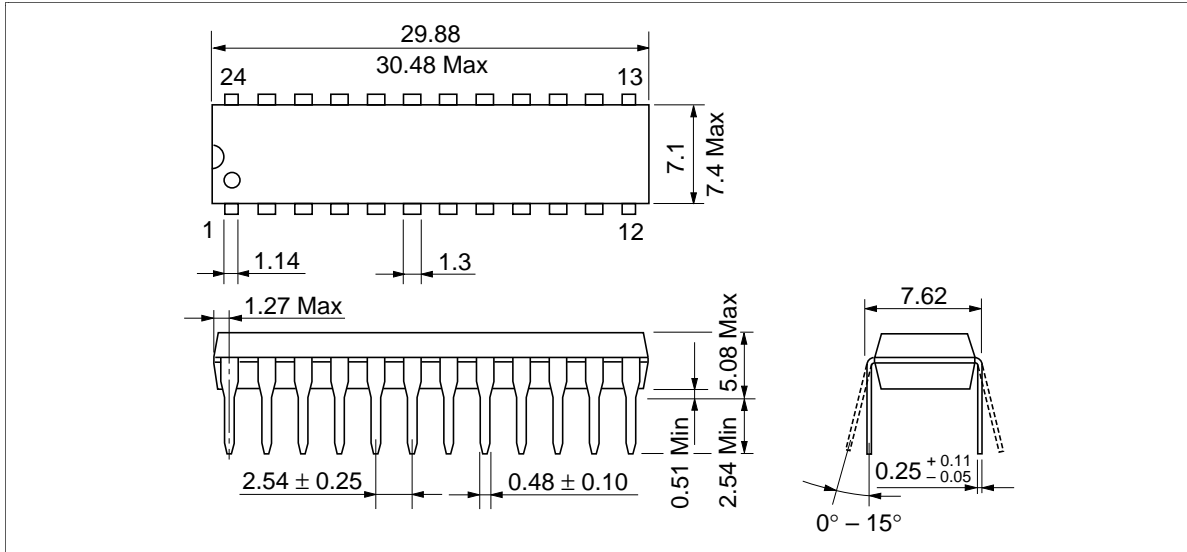

HM6208HJP/HLJP Series (CP-24D)

Unit: mm

