



28 V/66 W/100 W DC/DC Converters with Integral EMI Filter

ADDC02803SC/ADDC02805SA

FEATURES

28 V dc Input, 5 V dc @ 20 A, 100 W Output
(ADDC02805SA)

28 V dc Input, 3.3 V dc @ 20 A, 66 W Output
(ADDC02803SC)

Integral EMI Filter Designed to Meet MIL-STD-461D

Low Weight: 80 Grams

NAVMAT Derated

Many Protection and System Features

APPLICATIONS

Commercial and Military Airborne Electronics

Missile Electronics

Space-Based Antennae and Vehicles

Mobile/Portable Ground Equipment

Distributed Power Architecture for Active Array Radar

GENERAL DESCRIPTION

The ADDC02803SC and ADDC02805SA hybrid dc/dc converters with integral EMI filters offer the highest power density of any dc/dc converter with their features and in their power range available today. The converters with integral EMI filters are fixed frequency, 1 MHz square wave switching dc/dc power supplies. They are not variable frequency resonant converters. In addition to many protection features, these converters have system level features that allow them to be used as components in larger systems as well as stand-alone power supplies. The units are designed for high reliability and high performance applications where saving space and/or weight are critical.

The ADDC02803SC and ADDC02805SA are available in three screening grades; all grades use a hermetically sealed, molybdenum based hybrid package. Three screening levels are available, including military SMD.

FUNCTIONAL BLOCK DIAGRAM

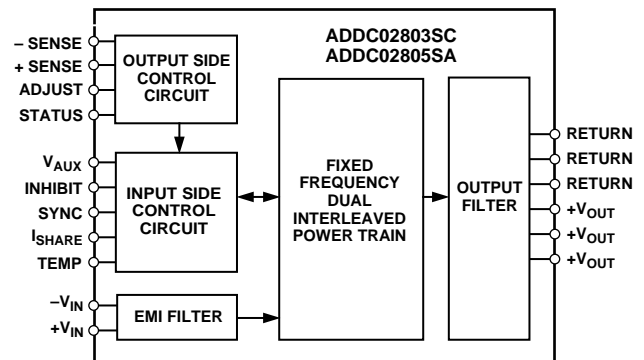

PRODUCT HIGHLIGHTS

1. Up to 60 W/cubic inch power density with an integral EMI filter designed to meet all applicable requirements in MIL-STD-461D when installed in a typical system setup.
2. Light weight: 80 grams
3. Operational and survivable over a wide range of input conditions: 16 V–50 V dc; survives low line, high line and positive and negative transients. See section entitled: Input Voltage Range.
4. High reliability; NAVMAT derated
5. Protection features include:
 - Output Overvoltage Protection
 - Output Short Circuit Current Protection
 - Thermal Monitor/Shutdown
 - Input Overvoltage Shutdown
 - Input Transient Protection
6. System level features include:
 - Current Sharing for Parallel Operation
 - Inhibit Control
 - Output Status Signal
 - Synchronization for Multiple Units
 - Input Referenced Auxiliary Voltage Supply

REV. A

Information furnished by Analog Devices is believed to be accurate and reliable. However, no responsibility is assumed by Analog Devices for its use, nor for any infringements of patents or other rights of third parties which may result from its use. No license is granted by implication or otherwise under any patent or patent rights of Analog Devices.

One Technology Way, P.O. Box 9106, Norwood, MA 02062-9106, U.S.A.
Tel: 781/329-4700 World Wide Web Site: <http://www.analog.com>
Fax: 781/326-8703 © Analog Devices, Inc., 1998

ADDC02803SC/ADDC02805SA—SPECIFICATIONS

ELECTRICAL CHARACTERISTICS ($T_C = +25^\circ\text{C}$, $V_{IN} = 28\text{ V dc} \pm 0.5\text{ V dc}$, unless otherwise noted; full temperature range is -55°C to $+90^\circ\text{C}$; all temperatures are case and T_C is the temperature measured at the center of the package bottom.)

Parameter	Case Temp	Test Level	Conditions	ADDC02803SC			ADDC02805SA			Units
				Min	Typ	Max	Min	Typ	Max	
INPUT CHARACTERISTICS										
Steady State Operating Input Voltage Range ¹	Full	VI	$I_O = 2\text{ A to }20\text{ A}$	18	28	40	18	28	40	V
Abnormal Operating Input Voltage Range (Per MIL-STD-704D) ¹	Full	VI	$I_O = 2\text{ A to }16\text{ A}$	16		50	16		50	V
Input Overvoltage Shutdown	+25°C	I		50	52.5	55	50	52.5	55	V
No Load Input Current	+25°C	I				90			90	mA
Disabled Input Current	Full	VI			0.85	2.0	0.85	2.0		mA
OUTPUT CHARACTERISTICS ^{2, 3}										
Output Voltage (V_O)	+25°C	I	$I_O = 2\text{ A to }20\text{ A}$, $V_{IN} = 18\text{ V to }40\text{ V dc}$	3.26	3.30	3.34	5.00	5.025	5.05	V
	Full	VI	$I_O = 2\text{ A to }20\text{ A}$, $V_{IN} = 18\text{ V to }40\text{ V dc}$	3.2		3.4	4.925		5.125	V
	Full	VI	$I_O = 2\text{ A to }16\text{ A}$, $V_{IN} = 16\text{ V to }50\text{ V dc}$	3.2		3.4	4.925		5.125	V
Line Regulation	+25°C	V	$I_O = 20\text{ A}$, $V_{IN} = 18\text{ V to }40\text{ V dc}$		1		1			mV
Load Regulation	+25°C	V	$V_{IN} = 28\text{ V dc}$, $I_O = 2\text{ A to }20\text{ A}$		1		1			mV
Output Ripple/Noise ⁴	+25°C	I	$I_O = 20\text{ A}$, 5 kHz – 2 MHz BW		15	35	15	50		mV p-p
Output Current (I_O)	Full	VI	$V_{IN} = 18\text{ V to }40\text{ V dc}$	2		21.2	2		20	A
Output Overvoltage Protection	+25°C	V	$I_O = 20\text{ A}$, Open Remote Sense Connection		145		125			% V_O Nom
Output Current Limit	+25°C	V	$V_O = 90\% V_{OUT}$ Nom				130			% I_O max
Output Short Circuit Current	+25°C	I			39			35		A
ISOLATION CHARACTERISTICS										
Isolation Resistance	+25°C	I	Input to Output or Any Pin to Case at 500 V dc	100			100			MΩ
DYNAMIC CHARACTERISTICS ⁴										
Output Voltage Deviation Due to Step Change in Load	+25°C	V	$I_O = 10\text{ A to }20\text{ A}$ or $20\text{ A to }10\text{ A}$, $di/dt = 0.5\text{ A}/\mu\text{s}$		350		500			mV
Response Time Due to Step Change in Load	+25°C	V	$I_O = 10\text{ A to }20\text{ A}$ or $20\text{ A to }10\text{ A}$, $di/dt = 0.5\text{ A}/\mu\text{s}$, Time for V_{OUT} to Return within 2% of Final Value		135		125			μs
Soft Start Turn-On Time ⁵	+25°C	I	$I_O = 20\text{ A}$, From Inhibit High to Status High		1	4	7	20		ms
THERMAL CHARACTERISTICS										
Efficiency	+25°C	I	$I_O = 12\text{ A}$	75	79		77	80		%
	Max	VI	$I_O = 12\text{ A}$	75			77			%
	Min	VI	$I_O = 12\text{ A}$	72			75			%
	+25°C	I	$I_O = 20\text{ A}$	74	77		77	79		%
	Max	VI	$I_O = 20\text{ A}$	74			77			%
	Min	VI	$I_O = 20\text{ A}$	73			75			%
Hottest Junction Temperature ⁶	+90°C	V	$I_O = 20\text{ A}$		110		110			°C
CONTROL CHARACTERISTICS										
Clock Frequency	Full	VI	$I_O = 2\text{ A}$	0.85		0.99	0.85		0.99	MHz
ADJUST (Pin 3) V ADJ	+25°C	I		1.26	1.32	1.38	1.92	2.04	2.10	V
STATUS (Pin 4)										
V_{OH}	+25°C	I	$I_{OH} = 400\text{ }\mu\text{A}$	2.4	4.0		2.4	4.0		V
V_{OL}	+25°C	I	$I_{OL} = 1\text{ mA}$		0.15	0.7		0.15	0.7	V
V_{AUX} (Pin 5)										
V_O (nom)	+25°C	I	$I_{AUX} = 5\text{ mA}$, Load Current = 20 A	13.2	13.7	14.2	14.3	14.7	15.3	V
INHIBIT (Pin 6)										
V_{IL}	+25°C	I				0.5			0.5	V
I_{IL}	+25°C	I	$V_{IL} = 0.5\text{ V}$			1.2			1.2	mA
V_I (Open Circuit)	+25°C	I				15			15	V
SYNC (Pin 7) ⁷										
V_{IH}	+25°C	I		4.0			4.0			V
I_{IH}	+25°C	I	$V_{IH} = 7.0\text{ V}$			175			175	μA
I_{SHARE} (Pin 8)	+25°C	I	$I_O = 20\text{ A}$	2.62	2.72	2.82	2.75	2.82	2.95	V
TEMP (Pin 9)	+25°C	V			3.90			3.90		V

NOTES

¹50 V dc upper limit rated for transient condition of up to 50 ms. 16 V dc lower limit rated for continuous operation during emergency condition. Steady state and abnormal input voltage range require source impedance sufficient to insure input stability at low line. See sections entitled System Instability Considerations and Input Voltage Range.

²Measured at the remote sense points.

³Unit regulates output voltage to zero load.

⁴ $C_{LOAD} = 0$.

⁵Output is fully loaded into a constant resistive load.

⁶Refer to section entitled Thermal Characteristics for more information.

⁷Unit has internal pull-down; refer to section entitled Pin 7 (SYNC).

Specifications subject to change without notice.

ADDC02803SC/ADDC02805SA

ABSOLUTE MAXIMUM RATINGS*

INHIBIT	50 V dc, -0.5 V dc
SYNC	8.0 V dc, -0.5 V dc
I _{SHARE}	6 V dc, -0.5 V dc
TEMP	12 V dc, -0.3 V dc
Common-Mode Voltage, Input to Output	500 V dc
Lead Soldering Temp (10 sec)	+300°C
Storage Temperature	-65°C to +150°C
Maximum Junction Temperature	+150°C
Maximum Case Operating Temperature	+125°C

*Absolute maximum ratings are limiting values, to be applied individually, and beyond which the serviceability of the circuit may be impaired. Functional operability under any of these conditions is not necessarily implied. Exposure of absolute maximum rating conditions for extended periods of time may affect device reliability.

ORDERING INFORMATION

Device	Operating Temperature Range (Case)	Description
ADDC02803SCKV	-40°C to +85°C	Hermetic Package
ADDC02803SCTV	-55°C to +90°C	Hermetic Package
5962-9760101HXC (ADDC02803SCTV/QMLH)	-55°C to +125°C	Hermetic Package
ADDC02805SAKV	-40°C to +85°C	Hermetic Package
ADDC02805SATV	-55°C to +90°C	Hermetic Package
5962-9570701HXC (ADDC02805SATV/QMLH)	-55°C to +125°C	Hermetic Package

EXPLANATION OF TEST LEVELS

Test Level

- I - 100% production tested.
- II - 100% production tested at +25°C, and sample tested at specified temperatures.
- III - Sample tested only.
- IV - Parameter is guaranteed by design and characterization testing.
- V - Parameter is a typical value only.
- VI - All devices are 100% production tested at +25°C. 100% production tested at temperature extremes for military temperature devices; guaranteed by design and characterization testing for industrial devices.

PIN DESCRIPTIONS

Pin No.	Name	Function
1	-SENSE	Feedback loop connection for remote sensing output voltage. Must always be connected to output return for proper operation.
2	+SENSE	Feedback loop connection for remote sensing output voltage. Must always be connected to +V _{OUT} for proper operation.
3	ADJUST	Adjusts output voltage setpoint.
4	STATUS	Indicates output voltage is within ±5% of nominal. Active high referenced to -SENSE (Pin 1).
5	V _{AUX}	Low level dc auxiliary voltage supply referenced to input return (Pin 10).
6	INHIBIT	Power Supply Inhibit. Active low and referenced to input return (Pin 10).
7	SYNC	Clock synchronization input for multiple units; referenced to input return (Pin 10).
8	I _{SHARE}	Current share pin which allows paralleled units to share current typically within ±5% at full load; referenced to input return (Pin 10).
9	TEMP	Case temperature indicator and temperature shutdown override; referenced to input return (Pin 10).
10	-V _{IN}	Input Return.
11	+V _{IN}	+28 V Nominal Input Bus.
12	+V _{OUT}	+5 V dc Output (ADDC02805SA). +3.3 V dc Output (ADDC02803SC).
13	+V _{OUT}	+5 V dc Output (ADDC02805SA). +3.3 V dc Output (ADDC02803SC).
14	+V _{OUT}	+5 V dc Output (ADDC02805SA). +3.3 V dc Output (ADDC02803SC).
15	RETURN	Output Return.
16	RETURN	Output Return.
17	RETURN	Output Return.

PIN CONFIGURATION

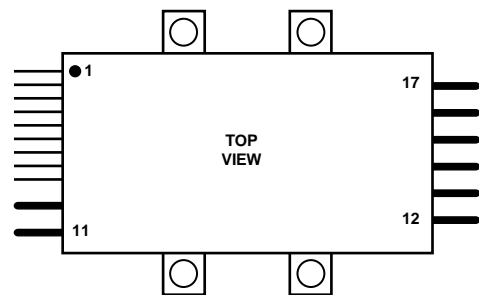

CAUTION

ESD (electrostatic discharge) sensitive device. Electrostatic charges as high as 4000 V readily accumulate on the human body and test equipment and can discharge without detection. Therefore, proper ESD precautions are recommended to avoid performance degradation or loss of functionality.



ADDC02803SC/ADDC02805SA—Typical Performance Curves

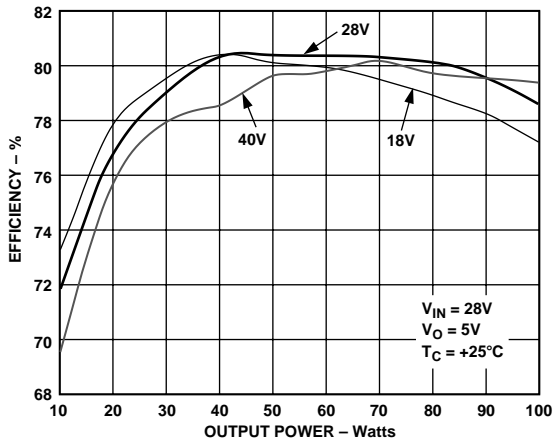

Figure 1. Efficiency vs. Line and Load at +25°C (ADDC02805SA)

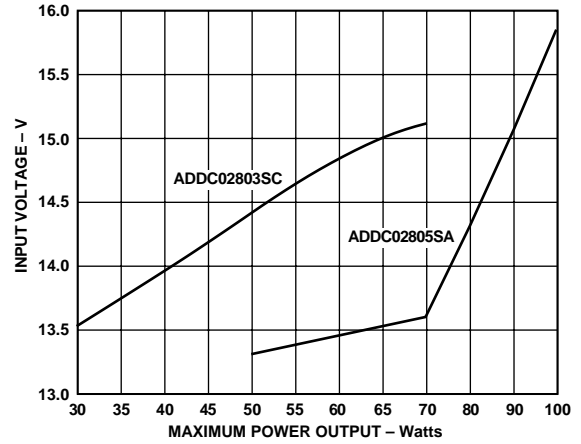

Figure 4. Low Line Dropout vs. Load at +90°C Case Temperature

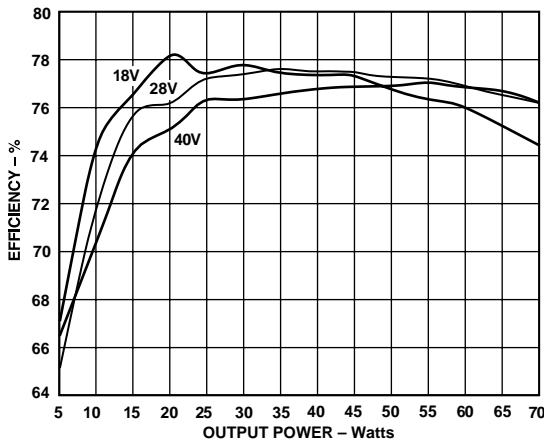

Figure 2. Efficiency vs. Line and Load at +25°C (ADDC02803SC)

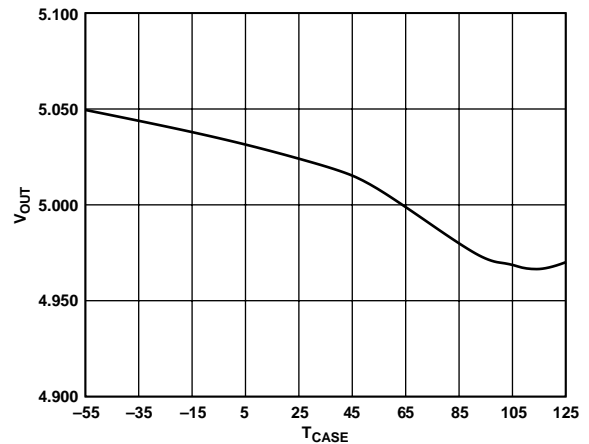

Figure 5. Output Voltage vs. Case Temperature (°C) (ADDC02805SA)

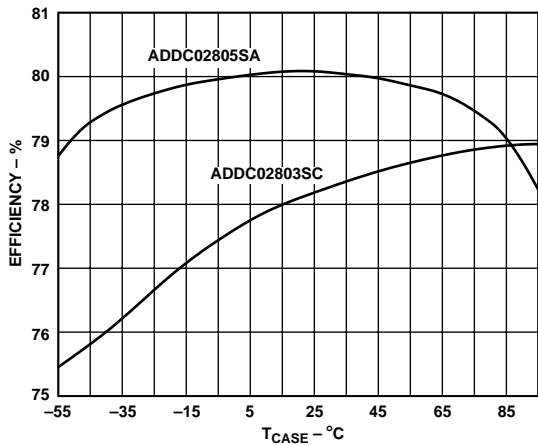

Figure 3. Efficiency vs. Case Temperature (°C) (at Nominal V_{IN} , 75% Max Load)

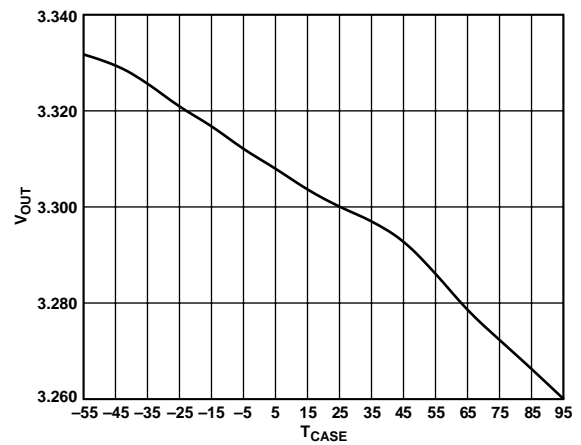

Figure 6. Output Voltage vs. Case Temperature (°C) (ADDC02803SC)

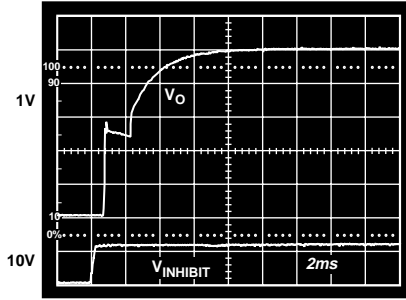

Figure 7. Output Voltage Transient During Turn-On with Minimum Load Displaying Soft Start When Supply Is Enabled (ADDC02805SA)

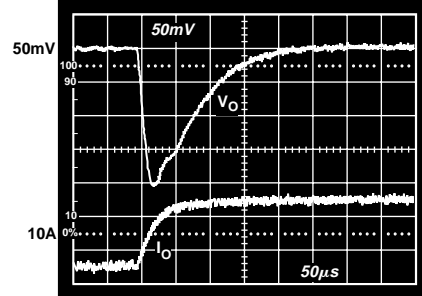

Figure 10. Output Voltage Transient Response to a 10 A to 20 A Step Change in Load with Zero Load Capacitance (ADDC02803SC)

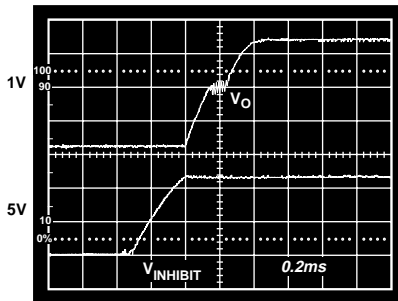

Figure 8. Output Voltage Transient During Turn-On with Minimum Load Displaying Soft Start When Supply Is Enabled (ADDC02803SC)

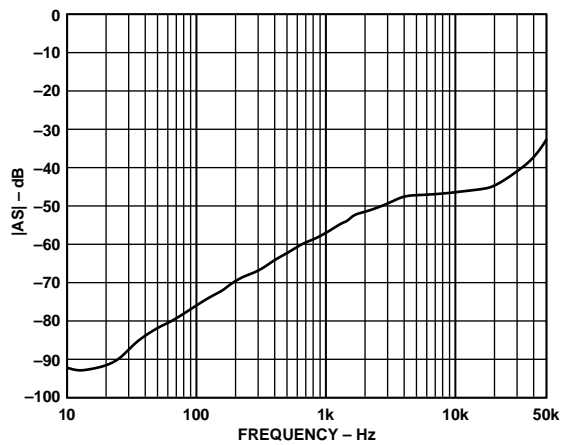

Figure 11. Audio Susceptibility (Magnitude of V_{OUT}/V_{IN}) (ADDC02805SA)

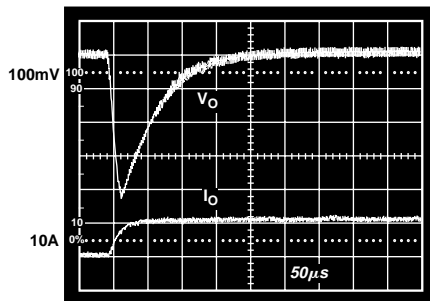

Figure 9. Output Voltage Transient Response to a 10 A to 20 A Step Change in Load with Zero Load Capacitance (ADDC02805SA)

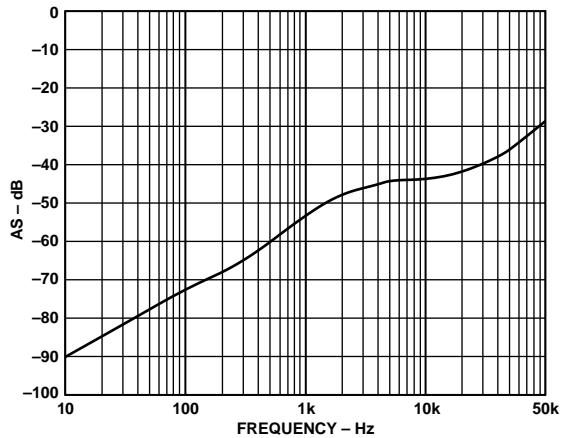

Figure 12. Audio Susceptibility (Magnitude of V_{OUT}/V_{IN}) (ADDC02803SC)

ADDC02803SC/ADDC02805SA

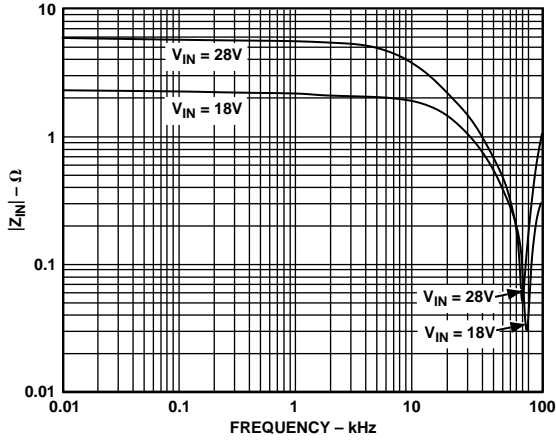

Figure 13. Incremental Input Impedance (Magnitude) (ADDC02805SA)

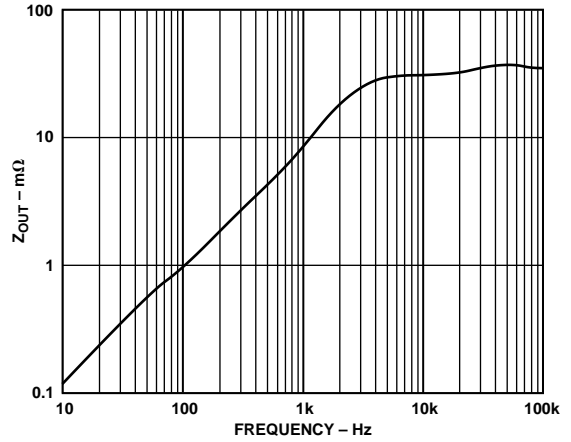

Figure 16. Incremental Output Impedance (Magnitude) (ADDC02803SC)

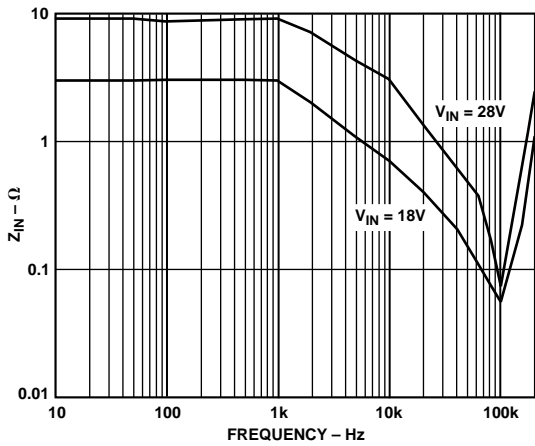

Figure 14. Incremental Input Impedance (Magnitude) (ADDC02803SC)

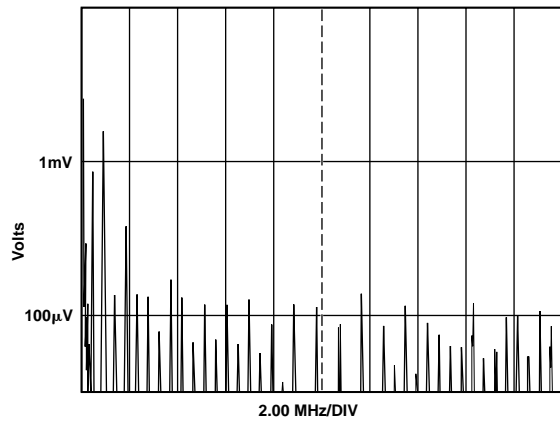

Figure 17. Output Voltage Ripple Spectrum (ADDC02803SC)

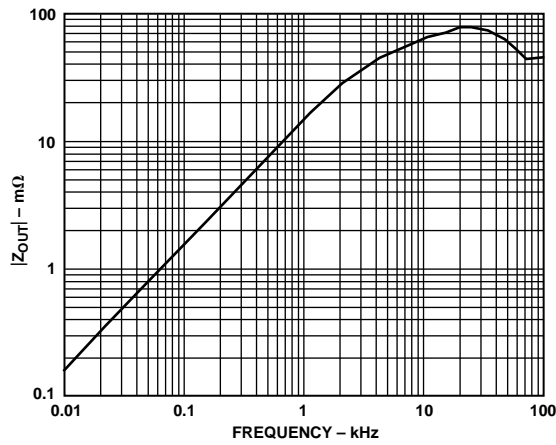

Figure 15. Incremental Output Impedance (Magnitude) (ADDC02805SA)

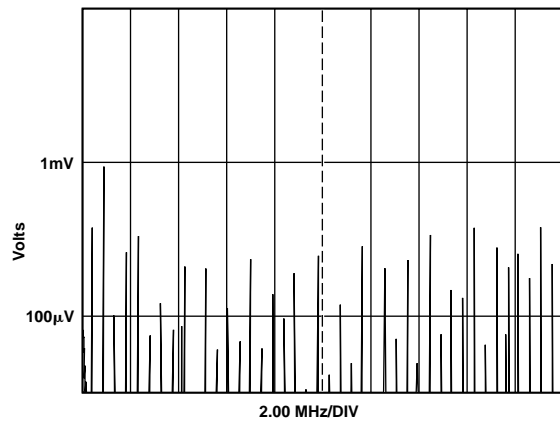

Figure 18. Output Voltage Ripple Spectrum (ADDC02805SA)

Typical EMI Curves and Test Setup—ADDC02805SA

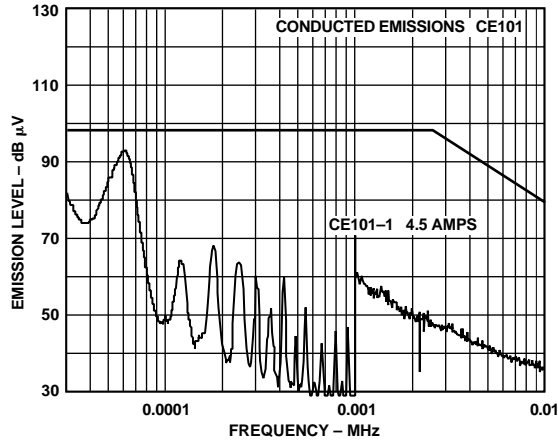

Figure 19. Conducted Emissions, MIL-STD-461D, CE101, +28 V Hot Line, 100 W Load

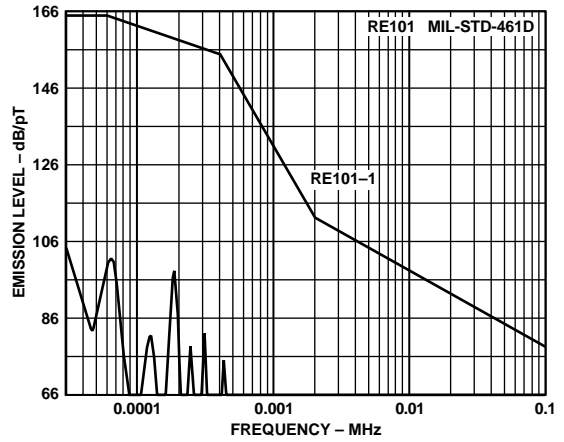

Figure 21. Radiated Emissions, MIL-STD-461D, RE101, 100 W Load

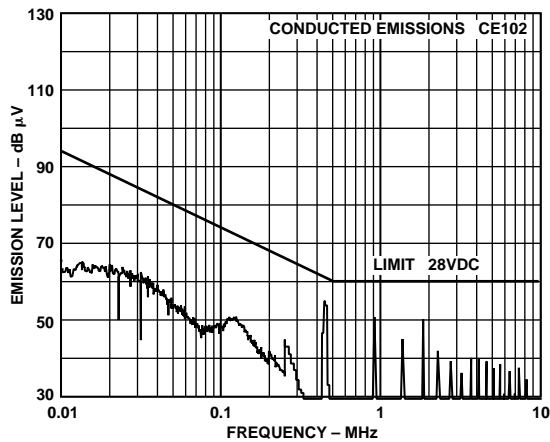

Figure 20. Conducted Emissions, MIL-STD-461D, CE102, +28 V Hot Line, 100 W Load

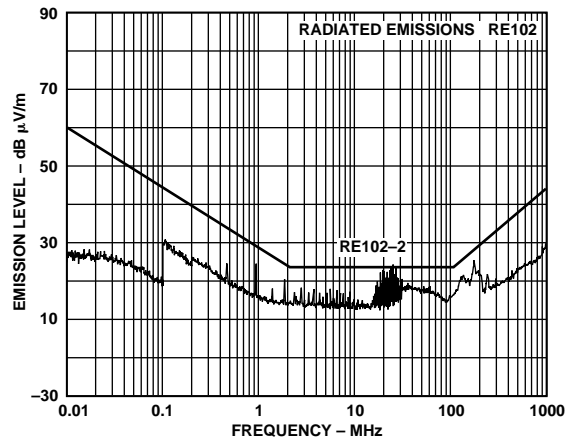
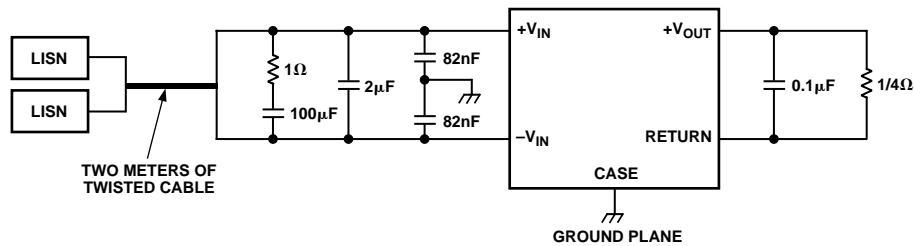

Figure 22. Radiated Emissions, MIL-STD-461D, RE102, Vertical Polarity, 100 W Load



NOTE: 100 μ F CAPACITOR AND 1 Ω RESISTOR PROVIDE STABILIZATION FOR 100 μ H DIFFERENTIAL SOURCE INDUCTANCE INTRODUCED BY THE LISNs. REFER TO SECTION ON EMI CONSIDERATIONS FOR MORE INFORMATION.

Figure 23. Schematic of Test Setup for EMI Measurements

ADDC02803SC/ADDC02805SA

BASIC OPERATION

The ADDC02803SC and ADDC02805SA converters use a flyback topology with dual interleaved power trains operating 180° out of phase. Each power train switches at a fixed frequency of 500 kHz, resulting in a 1 MHz fixed switching frequency as seen at the input and output of the converter. In a flyback topology, energy is stored in the inductor during one half portion of the switching cycle and is then transferred to the output filter during the next half portion. With two interleaved power trains, energy is transferred to the output filter during both halves of the switching cycle, resulting in smaller filters to meet the required ripple.

A five pole differential input EMI filter, along with a common-mode EMI capacitor and careful attention to layout parasitics, is designed to meet all applicable requirements in MIL-STD-461D when installed in a typical system setup. A more detailed discussion of CE102 and other EMI issues is included in the section entitled EMI Considerations.

The converters use current mode control and employ a high performance opto-isolator in its feedback path to maintain isolation between input and output. The control circuit is designed to give a nearly constant output current as the output voltage drops from V_O nom to V_{SC} during a short circuit condition. It does not let the current fold back below the maximum rated output current. The output overvoltage protection circuitry, which is independent of the normal feedback loop, protects the load against a break in the remote sense leads. Remote sense connections, which can be made at the load, can adjust for voltage drops of as much as 0.25 V dc between the converter and the load, thereby maintaining an accurate voltage level at the load.

An input overvoltage protection feature shuts down the converter when the input voltage exceeds (nominally) 52.5 V dc.

An internal temperature sensor shuts down the unit and prevents it from becoming too hot if the heat removal system fails. The temperature sensed is the case temperature and is factory set to trip at a nominal case temperature of 110°C to 115°C. The shutdown temperature setting can be raised externally or disabled by the user.

Each unit has an INHIBIT pin that can be used to turn off the converter. This feature can be used to sequence the turn-on of multiple converters and to reduce input power draw during extended time in a no load condition.

A SYNC pin, referenced to the input return line (Pin 10), is available to synchronize multiple units to one switching frequency. This feature is particularly useful in eliminating beat frequencies which may cause increased output ripple on paralleled units. A current share pin (I_{SHARE}) is available that permits paralleled units to share current typically within 5% at full load.

A low level dc auxiliary voltage supply referenced to the input return line is provided for miscellaneous system use.

PIN CONNECTIONS

Pins 1 and 2 (\pm SENSE)

Pins 1 and 2 must always be connected for proper operation, although failure to make these connections will not be catastrophic to the converter under normal operating conditions. Pin 1 must always be connected to the output return and Pin 2 must always be connected to $+V_{OUT}$. These connections can be made at any

one of the output pins of the converter, or remotely at the load. A remote connection at the load can adjust for voltage drops of as much as 0.25 V dc between the converter and the load.

Long remote sense leads can affect converter stability, although this condition is rare. The impedance of the long power leads between the converter and the remote sense point could affect the converter's unity gain crossover frequency and phase margin. Consult factory if long remote sense leads are to be used.

Pin 3 (ADJUST)

An adjustment pin is provided so that the user can change the nominal output voltage during the prototype stage. Since very low temperature coefficient resistors are used to set the output voltage and maintain tight regulation over temperature, using standard external resistors to adjust the output voltage will loosen output regulation over temperature. Furthermore, since the status trip point is not changed when the output voltage is adjusted using external resistors, the status line will no longer trip at the standard levels of the newly adjusted output voltage. If necessary, modified standard units can be ordered with the necessary changes made inside the package at the factory. The ADJUST function is sensitive to noise, and care should be taken in the routing of connections.

To make the output voltage higher, place a resistor from ADJUST (Pin 3) to $-SENSE$ (Pin 1). To make the output voltage lower, place a resistor from ADJUST (Pin 3) to $+SENSE$ (Pin 2). Figures 24 and 25 show resistor values for a $\pm 5\%$ change in output voltage:

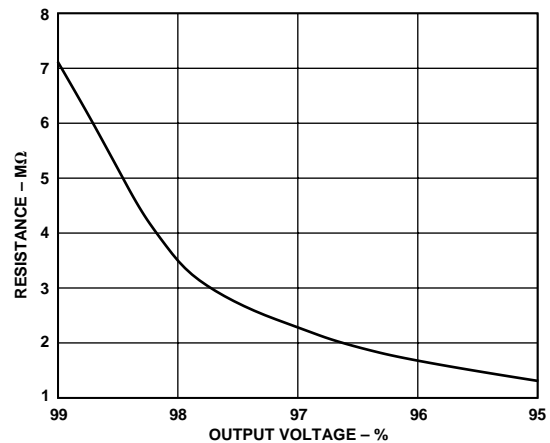

Figure 24. External Resistor Value for Reducing Output Voltage

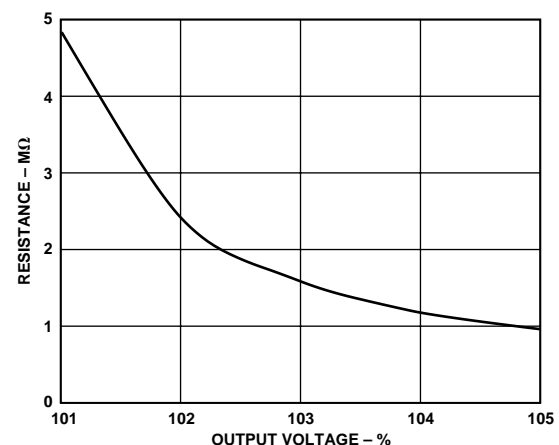

Figure 25. External Resistor for Increasing Output Voltage

With regard to the range to which the output voltage can be adjusted by the user, there are two concerns. As the output voltage is raised it may become difficult to maintain regulation at full power and low input voltage. As the output voltage is lowered, it may become difficult to maintain regulation at minimum power and high input line. In addition, if the output voltage is reduced below 3 V, the secondary side control circuit may not have a sufficient supply voltage to operate correctly.

Pin 4 (STATUS)

Pin 4 is active high referenced to $-SENSE$ (Pin 1), indicating that the output voltage is typically within $\pm 5\%$. The pin is both pulled up and down by internal circuitry. Figures 26, 27 and 28 show the typical source and sink capabilities of the status output. Refer to the paragraphs describing Pin 3 (ADJUST) for effect on status trip point.

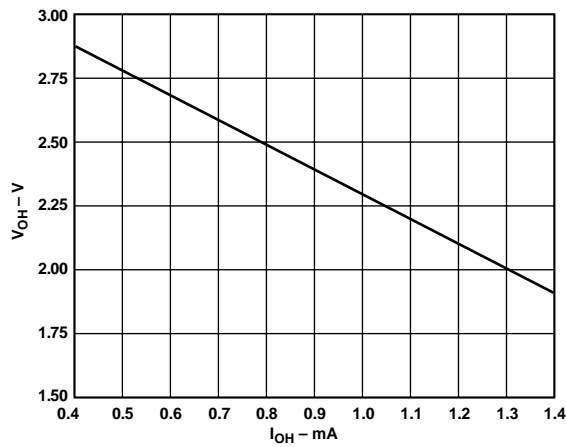

Figure 26. Source Capability of Status Output (ADDC02803SC)

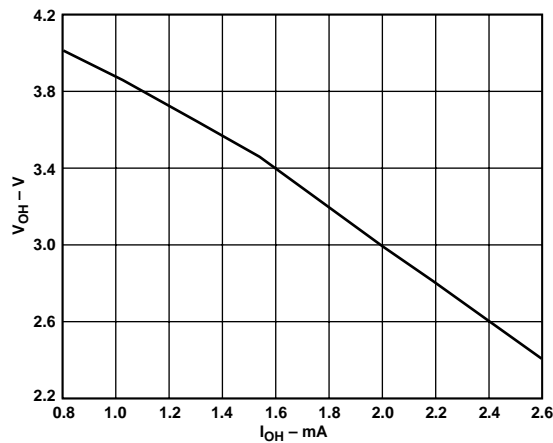

Figure 27. Source Capability of Status Output (ADDC02805SA)

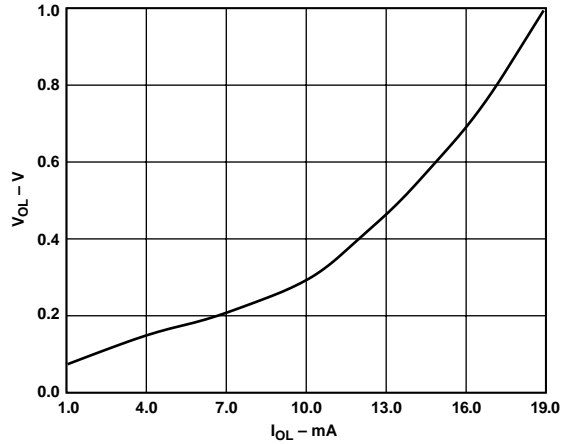

Figure 28. Sink Capability of Status Output

Pin 5 (V_{AUX})

Pin 5 is referenced to the input return and provides a semi-regulated 13 V to 15 V dc voltage supply for miscellaneous system use. The maximum permissible current draw is 5 mA and the voltage varies with the output load of the converter as shown in Figures 29 and 30.

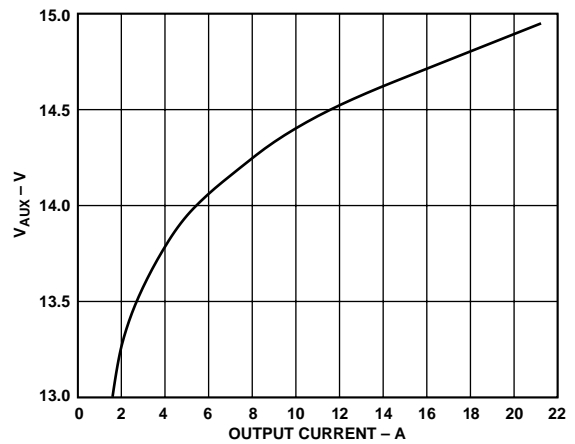

Figure 29. V_{AUX} vs. Converter Output Current (ADDC02805SA)

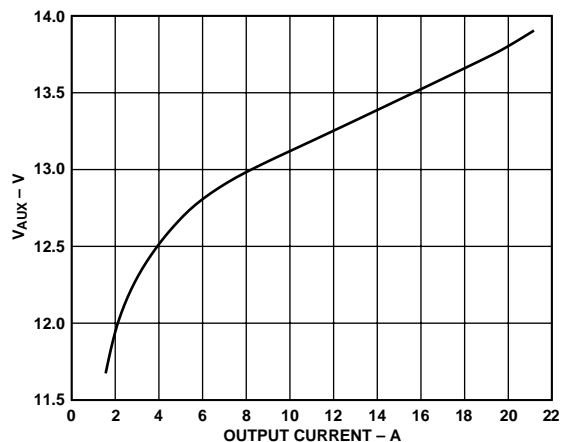

Figure 30. V_{AUX} vs. Converter Output Current (ADDC02803SC)

ADDC02803SC/ADDC02805SA

Pin 6 (INHIBIT)

Pin 6 is active low and is referenced to the input return of the converter. Connecting it to the input return will turn the converter off. For normal operation, the inhibit pin is internally pulled up to 12 V. Use of an open collector circuit is recommended.

When Pin 6 is disconnected from input return, the converter will restart in the soft-start mode. Pin 6 must be kept low for at least 2 milliseconds to initiate a full soft start. Shorter off times will result in a partial soft start. Figure 31 shows the input characteristics of Pin 6.

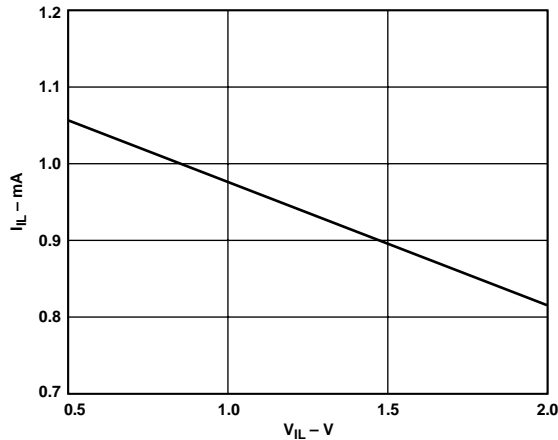

Figure 31. Input Characteristics of Pin 6 When Pulled Low

Pin 7 (SYNC)

Pin 7 can be used for connecting multiple converters to a master clock. This master clock can be either an externally user-supplied clock or a converter that has been modified and designated as a master unit. Capacitive coupling of the clock signal will ensure that if the master clock stops working the individual units will continue to operate at their own internal clock frequency, thereby eliminating a potential single point failure. Capacitive coupling will also permit a wider duty cycle to be used. Consult factory for more information. The SYNC pin has an internal pull-down so it is not necessary to sink any current when driving the pin low. Reference Figure 38 for a fault tolerant, secondary side powered SYNC drive circuit.

For user-supplied master clocks with no external circuitry, the following specifications must be met:

- Frequency: 1.00 MHz min
- Duty cycle: 7% min, 14% max
- High state voltage high level: 4 V min to 7 V max
- Low state voltage low level: 0 V min to 3.0 V max

Users should note that the SYNC pin is referenced to the input return of the converter. If the user-supplied master clock is generated on the output side of the converter, the signal should be isolated.

Users should be careful about the frequency selected for the external master clock. Higher switching frequencies will reduce efficiency and may reduce the amount of output power available at minimum input line. Consult factory for modified standard switching frequency to accommodate system clock characteristics.

Pin 8 (I_{SHARE})

Pin 8 allows paralleled converters to share the total load current, typically within $\pm 5\%$ at full load. To use the current share feature, connect all current share pins to each other and connect the SENSE pins on each of the converters. The current sharing function is sensitive to the differential voltage between the input return pins of paralleled converters. The current sharing function is also sensitive to noise, and care should be taken in the routing of connections. Refer to Figure 37 for typical application circuits using paralleled converters.

Pin 9 (TEMP)

Pin 9 can be used to indicate case temperature or to raise or disable the temperature at which thermal shutdown occurs. Typically, 3.90 V corresponds to $+25^\circ\text{C}$, with a $+13.1 \text{ mV}/^\circ\text{C}$ change for every 1°C rise. The sensor IC (connected from Pin 9 to the input return [Pin 10]) has a 13.1 k Ω impedance.

The thermal shutdown feature has been set to shut down the converter when the case temperature is nominally 110°C to 115°C . To raise the temperature at which shutdown occurs, connect a resistor with the value shown in Figure 32 from Pin 9 to the input return (Pin 10). To completely disable the temperature shutdown feature, connect a 50 k Ω resistor from Pin 9 to the input return (Pin 10).

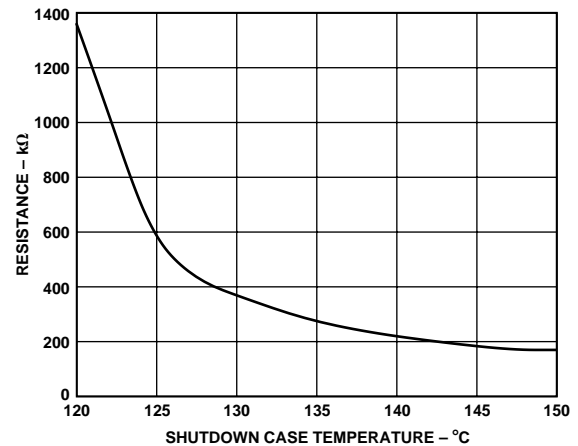

Figure 32. External Resistor Value for Raising Temperature Shutdown Point

INPUT VOLTAGE RANGE

The steady state operating input voltage range for the converter is defined as 18 V to 40 V. The abnormal operating input voltage range is defined as 16 V to 50 V. In accordance with MIL-STD-704D, the converter can operate up to 50 V dc input for transient conditions as long as 50 milliseconds, and it can operate down to 16 V dc input for continuous operation during emergency conditions. Figure 4 (typical low line dropout vs. load) shows that the converter can work continuously down to and below 16 V dc under reduced load conditions.

The ADDC02803SC and ADDC02805SA can be modified to survive, but not work through, the upper limit input voltages defined in MIL-STD-704A (aircraft) and MIL-STD-1275A (military vehicles). MIL-STD-704A defines an 80 V surge that lasts for 1 second before it falls below 50 V, while MIL-STD-1275A defines a 100 V surge that lasts for 200 milliseconds

before it falls below 50 V. In both cases, the ADDC02803SC/ADDC02805SA can be modified to operate to specification up to the 50 V input voltage limit and to shut down and protect itself during the time the input voltage exceeds 50 V. When the input voltage falls below 50 V as the surge ends, the converter will automatically initiate a soft start. In order to survive these higher input voltage surges, the modified converter will no longer have input transient protection, however, as described below.

Contact the factory for information on units surviving high input voltage surges.

Input Voltage Transient Protection: The converter has a transient voltage suppressor connected across its input leads to protect the unit against high voltage pulses (both positive and negative) of short duration. With the power supply connected in the typical system setup shown in Figure 23, a transient voltage pulse is created across the converter in the following manner. A 20 μF capacitor is first charged to 400 V. It is then directly connected across the converter's end of the two meter power lead cable through a 2 Ω on-state resistance MOSFET. The duration of this connection is 10 μs. The pulse is repeated every second for 30 minutes. This test is repeated with the connection of the 20 μF capacitor reversed to create a negative pulse on the supply leads. (If continuous reverse voltage protection is required, a diode can be added externally in series at the expense of lower efficiency for the power system.)

The converter responds to this input transient voltage test by shutting down due to its input overvoltage protection feature. Once the pulse is over, the converter initiates a soft-start, which is completed before the next pulse. No degradation of converter performance occurs.

THERMAL CHARACTERISTICS

Junction and Case Temperatures: It is important for the user to know how hot the hottest semiconductor junctions within the converter get, and to understand the relationship between junction, case and ambient temperatures. The hottest semiconductors in the 100 W product line of Analog Devices' high density power supplies are the switching MOSFETs and the output rectifiers. There is an area inside the main power transformers that is hotter than these semiconductors, but it is within NAVMAT guidelines and well below the Curie temperature of the ferrite. (The Curie temperature is the point at which the ferrite begins to lose its magnetic properties.)

Since NAVMAT guidelines require that the maximum junction temperature be 110°C, the power supply manufacturer must specify the temperature rise above the case for the hottest semiconductors so the user can determine the case temperature required to meet NAVMAT guidelines. The thermal characteristics section of the specification table states the hottest junction temperature for maximum output power at a specified case temperature. The unit can operate to case temperatures higher than 90°C, but 90°C is the maximum temperature that permits NAVMAT guidelines to be met.

Case and Ambient Temperatures: It is the user's responsibility to properly heat sink the power supply in order to maintain the appropriate case temperature and, in turn, the maximum

junction temperature. Maintaining the appropriate case temperature is a function of the ambient temperature and the mechanical heat removal system. The static relationship of these variables is established by the following formula:

$$T_C = T_A + (P_D \times R_{\theta_{CA}})$$

where:

- T_C = case temperature measured at the center of the package bottom,
- T_A = ambient temperature of the air available for cooling,
- P_D = the power, in watts, dissipated in the power supply,
- $R_{\theta_{CA}}$ = the thermal resistance from the center of the package to free air, or case to ambient.

The power dissipated in the power supply, P_D , can be calculated from the efficiency, η , given in the data sheets, and the actual output power, P_O , in the user's application by the following formula:

$$P_D = P_O \left(\frac{1}{\eta} - 1 \right)$$

For example, at 80 W of output power and 80% efficiency, the power dissipated in the power supply is 20 W. If under these conditions, the user wants to maintain NAVMAT deratings (i.e., a case temperature of approximately 90°C) with an ambient temperature of 75°C, the required thermal resistance, case to ambient, can be calculated as

$$90 = 75 + (20 \times R_{\theta_{CA}}) \text{ or } R_{\theta_{CA}} = 0.75^\circ\text{C/W}$$

This thermal resistance, case to ambient, will determine what kind of heat sink and whether convection cooling or forced air cooling is required to meet the constraints of the system.

SYSTEM INSTABILITY CONSIDERATIONS

In a distributed power supply architecture, a power source provides power to many "point-of-load" (POL) converters. At low frequencies, the POL converters appear incrementally as *negative* resistance loads. This negative resistance could cause system instability problems.

Incremental Negative Resistance: A POL converter is designed to hold its output voltage constant no matter how its input voltage varies. Given a constant load current, the power drawn from the input bus is therefore also a constant. If the input voltage increases by some factor, the input current must decrease by the same factor to keep the power level constant. In incremental terms, a positive incremental change in the input voltage results in a negative incremental change in the input current. The POL converter therefore looks, incrementally, like a negative resistor.

The value of this negative resistor at a particular operating point, V_{IN} , I_{IN} , is:

$$R_N = \frac{-V_{IN}}{I_{IN}}$$

Note that this resistance is a function of the operating point. At full load and low input line, the resistance is its smallest, while at light load and high input line, it is its largest.

ADDC02803SC/ADDC02805SA

Potential System Instability: The preceding analysis assumes dc voltages and currents. For ac waveforms the incremental input model for the POL converter must also include the effects of its input filter and control loop dynamics. When the POL converter is connected to a power source, modeled as a voltage source, V_S , in series with an inductor, L_S , and some positive resistor, R_S , the network of Figure 33 results.

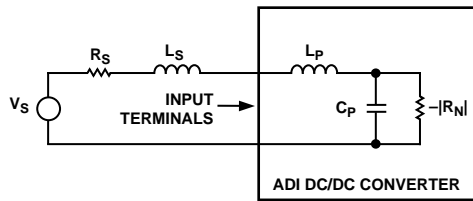

Figure 33. Model of Power Source and POL Converter Connection

The network shown in Figure 33 is second order and has the following characteristic equation:

$$s^2(L_S + L_P)C + s\left(\frac{(L_S + L_P)}{-|R_N|} + R_S C_P\right) + 1 = 0$$

For the power delivery to be efficient, it is required that $R_S \ll R_N$. For the system to be stable, however, the following relationship must hold:

$$C_P |R_N| > \frac{(L_S + L_P)}{R_S} \quad \text{or} \quad R_S > \frac{(L_S + L_P)}{C_P |R_N|}$$

Notice from this result that if $(L_S + L_P)$ is too large, or if R_S is too small, the system might be unstable. This condition would first be observed at low input line and full load since the absolute value of R_N is smallest at this operating condition.

If an instability results and it cannot be corrected by changing L_S or R_S , such as during the MIL-STD-461D tests due to the LISN requirement, one possible solution is to place a capacitor across the input of the POL converter. Another possibility is to place a small resistor in series with this extra capacitor.

The analysis has so far assumed the source of power was a voltage source (e.g., a battery) with some source impedance. In some cases, this source may be the output of a front-end (FE) converter. Although each FE converter is different, a model for a typical one would have an LC output filter driven by a voltage source whose value was determined by the feedback loop. The LC filter usually has a high Q, so the compensation of the feedback loop is chosen to help dampen any oscillations that result from load transients. In effect, the feedback loop adds “positive resistance” to the LC network.

When the POL converter is connected to the output of this FE converter, the POL’s “negative resistance” counteracts the effects of the FE’s “positive resistance” offered by the feedback loop. Depending on the specific details, this might simply mean that the FE converter’s transient response is slightly more oscillatory, or it may cause the entire system to be unstable.

For the ADDC02803SC and ADDC02805SA, L_P is approximately 1 μH and C_P is approximately 4 μF . Figures 13 and 14 show a more accurate depiction of the input impedance of the converter as a function of frequency. The negative resistance is, itself, a very good incremental model for the power state of the converter for frequencies into the several kHz range.

NAVMAT DERATING

NAVMAT is a Navy power supply reliability manual frequently cited by specifiers of power supplies. A key section of NAVMAT P4855-1A discusses guidelines for derating designs and their components. The two key derating criteria are voltage derating and power derating. Voltage derating is done to reduce the possibility of electrical breakdown, whereas power derating is done to maintain the component material below a specified maximum temperature. While power deratings are typically stated in terms of current limits (e.g., derate to x% of maximum rating), NAVMAT also specifies a maximum junction temperature of the semiconductor devices in a power supply. The NAVMAT component deratings applicable to the ADDC02805SA and ADDC02803SC are as follows:

Resistors

- 80% voltage derating
- 50% power derating

Capacitors

- 50% voltage and ripple voltage derating
- 70% ripple current derating

Transformers and Inductors

- 60% continuous voltage and current derating
- 90% surge voltage and current derating
- 20°C less than rated core temperature
- 30°C below insulation rating for hot spot temperature
- 25% insulation breakdown voltage derating
- 40°C maximum temperature rise

Transistors

- 50% power derating
- 60% forward current (continuous) derating
- 75% voltage and transient peak voltage derating
- 110°C maximum junction temperature

Diodes (Switching, General Purpose, Rectifiers)

- 70% current (surge and continuous) derating
- 65% peak inverse voltage derating
- 110°C maximum junction temperature

Diodes (Zeners)

- 70% surge current derating
- 60% continuous current derating
- 50% power derating
- 110°C maximum junction temperature

Microcircuits (Linears)

- 70% continuous current derating
- 75% signal voltage derating
- 110°C maximum junction temperature

The ADDC02803SC and ADDC02805SA can meet all the derating criteria listed above. There are, however, a few areas of the NAVMAT deratings where meeting the guidelines unduly sacrifices performance of the circuit. The standard unit therefore makes the following exceptions.

Common-Mode EMI Filter Capacitors: The standard supply uses 500 V capacitors to filter common-mode EMI. NAVMAT guidelines would require 1000 V capacitors to meet the 50% voltage derating (500 V dc input to output isolation), resulting in less common-mode capacitance for the same space. In typical electrical power supply systems, where the load ground is eventually connected to the source ground, common-mode voltages never get near the 500 V dc rating of the standard

supply. A lower voltage rating capacitor (500 V) was therefore chosen to fit more capacitance in the same space in order to better meet the conducted emissions requirement of MIL-STD-461D (CE102). For those applications requiring 250 V or less of isolation from input to output, the present designs would meet NAVMAT guidelines.

Switching Transistors: 100 V MOSFETs are used in the standard unit to switch the primary side of the transformers. Their nominal off-state voltage meets the NAVMAT derating guidelines. When the MOSFETs are turned off, however, momentary spikes occur that reach 100 V. The present generation of MOSFETs are rated for repetitive avalanche, a condition that was not considered by the NAVMAT deratings. In the worst case condition, the energy dissipated during avalanche is 1% of the device's rated repetitive avalanche energy. To meet the NAVMAT derating, 200 V MOSFETs could be used. The 100 V MOSFETs are used instead for their lower on-state resistance, resulting in higher efficiency for the power supply.

NAVMAT Junction Temperatures: The two types of power deratings (current and temperature) can be independent of one another. For instance, a switching diode can meet its derating of 70% of its maximum current, but its junction temperature can be higher than 110°C if the case temperature of the converter, which is not controlled by the manufacturer, is allowed to go higher. Since some users may choose to operate the power supply at a case temperature higher than 90°C, it then becomes important to know the temperature rise of the hottest semiconductors. This is covered in the specification table in the section entitled Thermal Characteristics.

EMI CONSIDERATIONS

The ADDC02803SC and ADDC02805SA have an integral differential- and common-mode EMI filter designed to meet all applicable requirements in MIL-STD-461D when the power converters are installed in a typical system setup (described below). The converters also contain transient protection circuitry that permit the units to survive short, high voltage transients across their input power leads. The purpose of this section is to describe the various MIL-STD-461D tests and the converters' corresponding performance. Consult factory for additional information.

The figures and tests referenced herein were obtained from measurements on the ADDC02805SA, a single 5 V dc output converter. Since the construction and topology of the 3.3 V output converter is almost identical to the 5 V dc output converter, and the component values of the EMI differential- and common-mode filter in the 3.3 V output converter are identical to the 5 V output converter, the text references these figures and tests as typical of the ADDC02803SC converter as well.

Electromagnetic interference (EMI) is governed by MIL-STD-461D, which establishes design requirements, and MIL-STD-462D, which defines test methods. EMI requirements are categorized as follows (xxx designates a three digit number):

- CExxx: conducted emissions (EMI produced internal to the power supply which is conducted externally through its input power leads)

- CSxxx: conducted susceptibility (EMI produced external to the power supply which is conducted internally through the input power leads and may interfere with the supply's operation)
- RExxx: radiated emissions (EMI produced internal to the power supply which is radiated into the surrounding space)
- RSxxx: radiated susceptibility (EMI produced external to the power supply which radiates into or through the power supply and may interfere with its proper operation)

It should be noted that there are several areas of ambiguity with respect to CE102 measurements that may concern the systems engineer. One area of ambiguity in this measurement is the nature of the load. If it is constant, the ripple voltage on the converter's input leads is due only to the operation of the converter. If, on the other hand, the load is changing over time, this variation causes an additional input current and voltage ripple to be drawn at the same frequency. If the frequency is high enough, the converter's filter will help attenuate this second source of ripple, but if it is below approximately 100 kHz, it will not. The system may then not meet the CE102 requirement, even though the converter is not the source of the EMI. If this is the case, additional capacitance may be needed across the load or across the input to the converter.

Another ambiguity in the CE102 measurement concerns common-mode voltage. If the load is left unconnected from the ground plane (even though the case is grounded), the common-mode ripple voltages will be smaller than if the load is grounded. The test specifications do not state which procedure should be used. However, in neither case (load grounded or floating) will the typical EMI test setup described below be exactly representative of the final system configuration EMI test. For the following reasons, the same is true if separately packaged EMI filters are used.

In almost all systems the output ground of the converter is ultimately connected to the input ground of the system. The parasitic capacitances and inductances in this connection will affect the common-mode voltage and the CE102 measurement. In addition, the inductive impedance of this ground connection can cause resonances, thereby affecting the performance of the common-mode filter in the power supply.

In response to these ambiguities, the Analog Devices' converter has been tested for CE102 under a constant load and with the output ground floating. While these measurements are a good indication of how the converter will operate in the final system configuration, the user should confirm CE102 testing in the final system configuration.

CE101: This test measures emissions on the input leads in the frequency range between 30 Hz and 10 kHz. The intent of this requirement is to ensure that the dc/dc converter does not corrupt the power quality (allowable voltage distortion) on the power buses present on the platform. There are several CE101 limit curves in MIL-STD-461D. The most stringent one applicable for the converter is the one for submarine applications. Figure 19 shows that the converter easily meets this requirement (the return line measurement is similar). The components at 60 Hz and its harmonics are a result of ripple in the output of the power source used to supply the converter.

ADDC02803SC/ADDC02805SA

CE102: This test measures emissions in the frequency range between 10 kHz and 10 MHz. The measurements are made on both of the input leads of the converter, which are connected to the power source through LISNs. The intent of this requirement, in the lower frequency portion of the requirement, is to ensure that the dc/dc converter does not corrupt the power quality (allowable voltage distortion) on the power buses present on the platform. At higher frequencies, the intent is to serve as a separate control from RE102 on potential radiation from power leads that may couple into sensitive electronic equipment.

Figure 20 shows the CE102 limit and the measurement taken from the +V_{IN} line. While the measurement taken from the input return line is slightly different, both comfortably meet the MIL-STD-461D, CE102 limit. (Reference the last section of EMI Considerations for how to adjust the external components in the test setup circuit to increase the margin between the specification limit and the measured results.)

CS101: This test measures the ability of the converter to reject low frequency differential signals, 30 Hz to 50 kHz, injected on the dc inputs. The measurement is taken on the output power leads. The intent is to ensure that equipment performance is not degraded from ripple voltages associated with allowable distortion of power source voltage waveforms. Figures 11 and 12 show typical audio susceptibility graphs. Note that according to the MIL-STD-461D test requirements, the injected signal between 30 Hz and 5 kHz has an amplitude of 2 V rms and from 5 kHz to 50 kHz the amplitude decreases inversely with frequency to 0.2 V rms. The curve of the injected signal should be multiplied by the audio susceptibility curve to determine the output ripple at any frequency. When this is done, the worst case output ripple at the frequency of the input ripple occurs at 5 kHz, at which point there is typically a 25 mV peak-to-peak output ripple.

It should be noted that MIL-STD-704 has a more relaxed requirement for rejection of low frequency differential signals injected on the dc inputs than MIL-STD-461D. MIL-STD-704 calls for a lower amplitude ripple to be injected on the input in a narrower frequency band, 10 Hz to 20 kHz.

CS114: This test measures the ability of the converter to operate correctly during and after being subjected to currents injected into bulk cables in the 10 kHz to 400 MHz range. Its purpose is to simulate currents that would be developed in these cables due to electromagnetic fields generated by antenna transmissions. The converter is designed to meet the requirements of this test when the current is injected on the input power leads cable. Consult factory for more information.

CS115: This test measures the ability of the converter to operate correctly during and after being subjected to 30 ns long pulses of current injected into bulk cables. Its purpose is to simulate transients caused by lightning or electromagnetic pulses. The converter is designed to meet this requirement when applied to its input power leads cable. Consult factory for more information.

CS116: This test measures the ability of the converter to operate correctly during and after being subjected to damped sinusoid transients in the 10 kHz to 100 MHz range. Its purpose is

to simulate current and voltage waveforms that would occur when natural resonances in the system are excited. The converter is designed to meet this requirement when applied to its input power leads cable. Consult factory for more information.

RE101: This requirement limits the strength of the magnetic field created by the converter in order to avoid interference with sensitive equipment located nearby. The measurement is made from 30 Hz to 100 kHz. The most stringent requirement is for the Navy. Figure 21 shows the test results when the pickup coil is held 7 cm above the converter. As can be seen, the converter easily meets this requirement.

RE102: This requirements limits the strength of the electric field emissions from the power converter to protect sensitive receivers from interference. The measurement is made from 10 kHz to 18 GHz with the antenna oriented in the vertical plane. For the 30 MHz and above range, the standard calls for the measurement to be made with the antenna oriented in the horizontal plane as well.

In a typical power converter system setup, the radiated emissions can come from two sources: 1) the input power leads as they extend over the two meter distance between the LISNs and the converter, as required for this test, and 2) the converter output leads and load. The latter is likely to create significant emissions if left uncovered, since minimal EMI filtering is provided at the converter's output. It is typical, however, that the power supply and its load would be contained in a conductive enclosure in applications where this test is applicable. For this test a metal screen was therefore used to cover the converter and its load.

Figure 22 shows test results for the vertical measurement and compares them against the most stringent RE102 requirement; the horizontal measurement (30 MHz and above) was similar. As can be seen, the emissions just meet the standard in the 18 MHz–28 MHz range. This component of the emissions is due to common-mode currents flowing through the input power leads. As mentioned in the section on CE102 above, the level of common-mode current that flows is dependent on how the load is connected. This measurement is therefore a good indication of how well the converter will perform in the final configuration; the user should confirm RE102 testing in the final system. (Reference the last section of EMI Considerations for how to adjust the external components in the test setup circuit to increase the margin between the specification limit and the measured results.)

RS101: This requirement is specialized and intended to check for sensitivity to low frequency magnetic fields in the 30 Hz to 50 kHz range. The converter is designed to meet this requirement. Consult factory for more information.

RS103: This test calls for correct operation during and after the unit under test is subjected to radiated electric fields in the 10 kHz to 40 GHz range. The intent is to simulate electromagnetic fields generated by antenna transmissions. The converter is designed to meet this requirement. Consult factory for more information.

Circuit Setup for EMI Test

Figure 23 shows a schematic of the test setup used for the EMI measurements discussed above. The output of the converter is connected to a resistive load designed to draw full power. There is a 0.1 μF capacitor placed across this resistor that typifies bypass capacitance normally used in this application. At the input of the converter there are two differential capacitors (the larger one having a series resistance) and two small common-mode capacitors connected to case ground. The case itself was connected to the metal ground plane in the test chamber. For the RE102 test, a metal screen box was used to cover both the converter and its load (but not the two meters of input power lead cables). This box was also electrically connected to the metal ground plane.

With regard to the components added to the input power lines, the 100 μF capacitor with its 1 Ω series resistance is required to achieve system stability when the unit is powered through the LISNs, as the MIL-STD-461D standard requires. These LISNs have a series inductance of 50 μH at low frequencies, giving a total differential inductance of 100 μH . As explained earlier in the System Instability section, such a large series source inductance will cause an instability as it interacts with the converter's negative incremental input resistance unless some corrective action is taken. The 100 μF capacitor and 1 Ω resistor provide the stabilization required.

It should be noted that the values of these stabilization components are appropriate for a single converter load. If the system makes use of several converters, the values of the components will need to be slightly changed, but not such that they are repeated for every converter. It should also be noted that most system applications will not have a source inductance as large as the 100 μH built into the LISNs. For those systems, a much smaller input capacitor could be used.

Increasing Margin Between Specification Limit and Measured Results

With regard to the 2 μF differential-mode capacitor and the two 82 nF common-mode capacitors, these components were included in the test setup to augment the performance of the power supply's internal EMI filter. The values were chosen to achieve the results shown in Figures 20 and 22. To increase the margin between the specification limits and the measured emissions, larger external component values could be used.

To do this it is useful to know that most of the emissions below 10 MHz, whether conducted or radiated, are due to differential-mode currents flowing in the input power leads. To make the emissions in this frequency range smaller, the differential capacitor value should be increased above 2 μF . Conversely, most of the emissions above 10 MHz are due to common-mode currents; to make them smaller the common-mode capacitors should be increased above the 82 nF value. In both cases it is important to minimize the parasitic inductance of the capacitors; the use of several smaller capacitors connected in parallel is one way to achieve this.

Using larger valued capacitors than those shown in Figure 23 is a good solution if an additional 6 dB–10 dB of margin is desired. If, however, in an extremely sensitive application it is

desired to increase the margin by 20 dB or more, it may be better to add both differential- and common-mode inductors to the external components to make a higher order filter.

RELIABILITY CONSIDERATIONS

MTBF (Mean Time Between Failure) is a commonly used reliability concept that applies to repairable items in which failed elements are replaced upon failure. The expression for MTBF is

$$MTBF = T/r$$

where:

T = total operating time

r = number of failures

In lieu of actual field data, MTBF can be predicted per MIL-HDBK-217.

MTBF, Failure Rate and Probability of Failure: A proper understanding of MTBF begins with its relationship to lambda (λ), which is the failure rate. If a constant failure rate is assumed, then $MTBF = 1/\lambda$, or $\lambda = 1/MTBF$. If a power supply has an MTBF of 1,000,000 hours, this does not mean it will last 1,000,000 hours before it fails. Instead, the MTBF describes the failure rate. For 1,000,000 hours MTBF, the failure rate during any hour is 1/1,000,000, or 0.0001%. Thus, a power supply with an MTBF of 500,000 hours would have twice the failure rate (0.0002%) of one with 1,000,000 hours.

What users should be interested in is the probability of a power supply not failing prior to some time t . Given the assumption of a constant failure rate, this probability is defined as

$$R(t) = e^{-\lambda t}$$

where $R(t)$ is the probability of a device not failing prior to some time t .

If we substitute $\lambda = 1/MTBF$ in the above formula, then the expression becomes

$$R(t) = e^{-\frac{t}{MTBF}}$$

This formula is the correct way to interpret the meaning of MTBF.

If we assume $t = MTBF = 1,000,000$ hours, then the probability that a power supply will not fail prior to 1,000,000 hours of use is e^{-1} , or 36.8%. This is quite different from saying the power supply will last 1,000,000 hours before it fails. The probability that the power supply will not fail prior to 50,000 hours of use is $e^{-0.05}$, or 95%. For $t = 10,000$ hours, the probability of no failure is $e^{-0.01}$, or 99%.

Temperature and Environmental Factors: Although the calculation of MTBF per MIL-HDBK-217 is a detailed process, there are two key variables that give the manufacturer significant leeway in predicting an MTBF rating. These two variables are temperature and environmental factor. For users to properly compare MTBF numbers from two different manufacturers, the environmental factor and the temperature must be identical. Contact the factory for MTBF calculations for specific environmental factors and temperatures.

ADDC02803SC/ADDC02805SA

MECHANICAL CONSIDERATIONS

When mounting the converter into the next higher level assembly, it is important to ensure good thermal contact is made between the converter and the external heat sink. Poor thermal connection can result in the converter shutting off, due to the temperature shutdown feature (Pin 9), or reduced reliability for the converter due to higher-than-anticipated junction and case temperatures. For these reasons the mounting tab locations were selected to ensure good thermal contact is made near the hot spots of the converter, which are shown in the shaded areas of Figure 34.

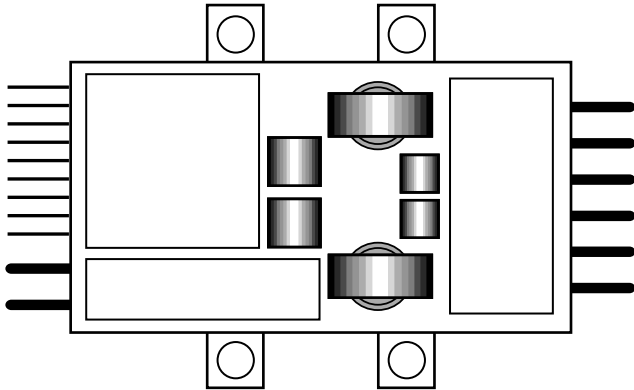

Figure 34. Hot Spots (Shaded Areas) of DC/DC Converter

The pins of the converter are typically connected to the next higher level assembly by bending them at right angles, either down or up, and cutting them shorter for insertion in printed circuit board through holes. In order to maintain the hermetic integrity of the seals around the pins, a fixture should be used for bending the pins without stressing the pin-to-sidewall seals. It is recommended that the minimum distance between the package edge and the inside of the pin be 100 mils (2.54 mm) for the 40 mil (1.02 mm) diameter pins; 120 mils (3.05 mm) from the package edge to the center of the pin as shown in Figure 35.

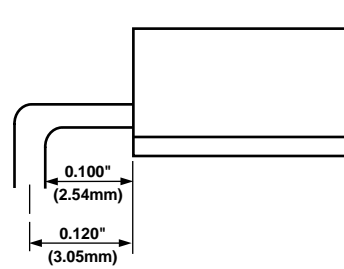

Figure 35. Minimum Bend Radius of 40 Mil (1.02 mm) Pins

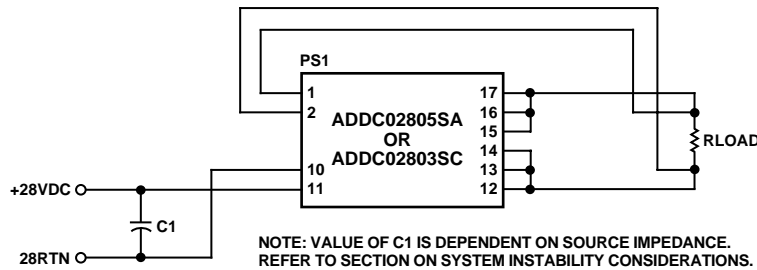

Figure 36. Typical Power Connections and External Parts for Converter

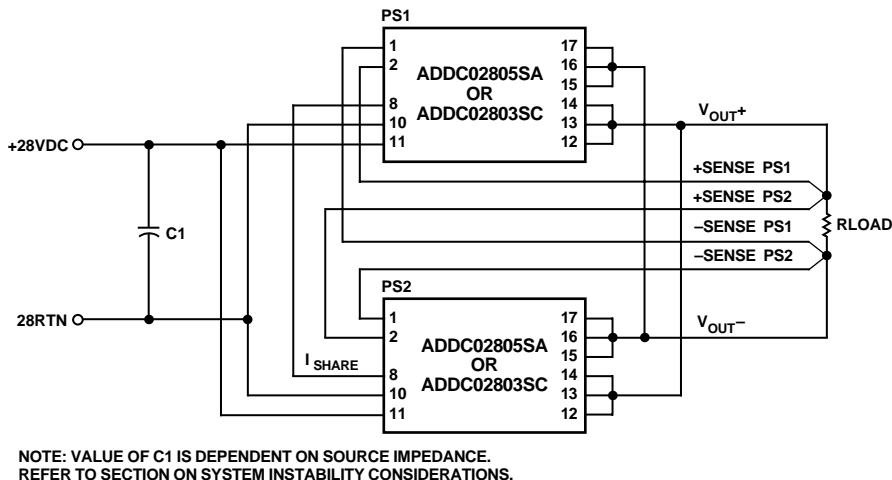

Figure 37. Typical Connections for Paralleling Two Converters

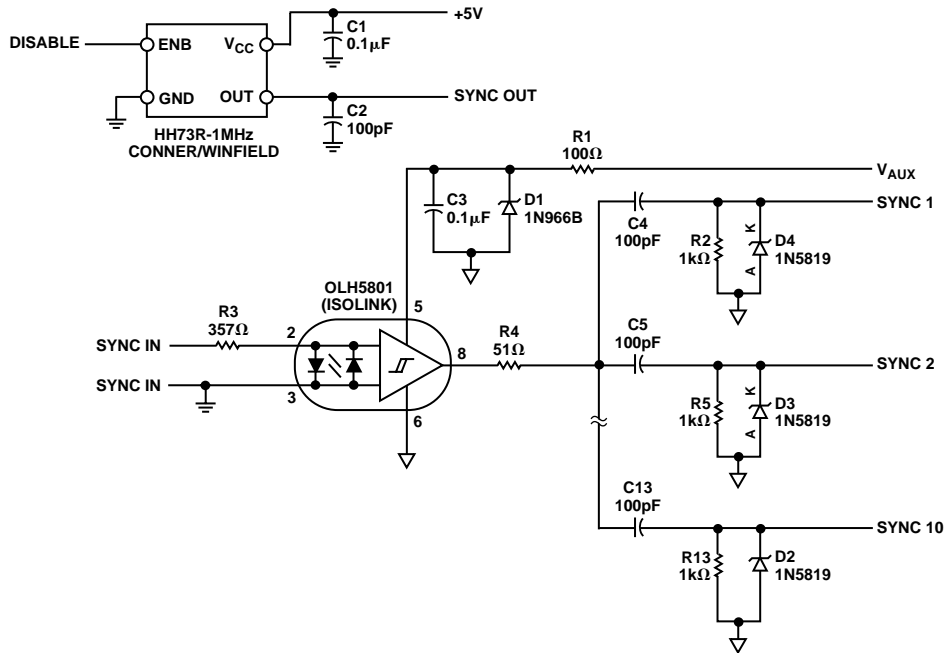

Figure 38. Fault Tolerant, Secondary Side Powered SYNC Drive Circuit

NOTES

1. *Input to Output Isolation:* With the use of the Isolink opto-coupler, we can use the output of the converters to power the Conner/Winfield 1 MHz clock (output referenced) and the V_{AUX} pin (input referenced) to power the opto-coupler.
2. *Fault Tolerant:* All outputs are capacitively coupled to ensure that if the master clock stops working the individual units will continue to operate at their own internal clock frequency, thereby eliminating a potential single point failure.
3. *Radiated Emissions:* C2 can be added to slow down the clock edges (Tr and Tf) for reducing radiated emissions.
4. *Table:* The following table shows the capacitor and resistor value to be used for the number of converters to be synchronized.

# of Converters	Capacitor Value (pF)	Resistor Value (ohms)
1	1000	100
2	470	200
3	330	300
4	270	400
5	220	500
6	180	600
7	150	700
8	120	800
9	100	900
10	100	1K

ADDC02803SC/ADDC02805SA

Screening Levels for ADDC02803SC/ADDC02805SA

Screening Steps	Industrial (KV)	Ruggedized Industrial (TV)	MIL-STD-883B/SMD (TV/QMLH)
Pre-Cap Visual	100%	MIL-STD-883, TM2017	Compliant to MIL-PRF-38534
Temp Cycle	N/A	N/A	
Constant Acceleration	N/A	N/A	
Fine Leak	Guaranteed to Meet MIL-STD-883, TM1014	Guaranteed to Meet MIL-STD-883, TM1014	
Gross Leak	Guaranteed to Meet MIL-STD-883, TM1014	Guaranteed to Meet MIL-STD-883, TM1014	
Burn-In	N/A	MIL-STD-883, TM1015, 96 Hrs at +125°C Case	
Final Electrical Test	At +25°C, Per Specification Table	At +25°C, Per Specification Table	

C3056a-4-10/98

NOMINAL CASE DIMENSIONS IN INCHES AND (mm)

(All tolerances ± 0.005 " [± 0.13 mm] unless otherwise specified)

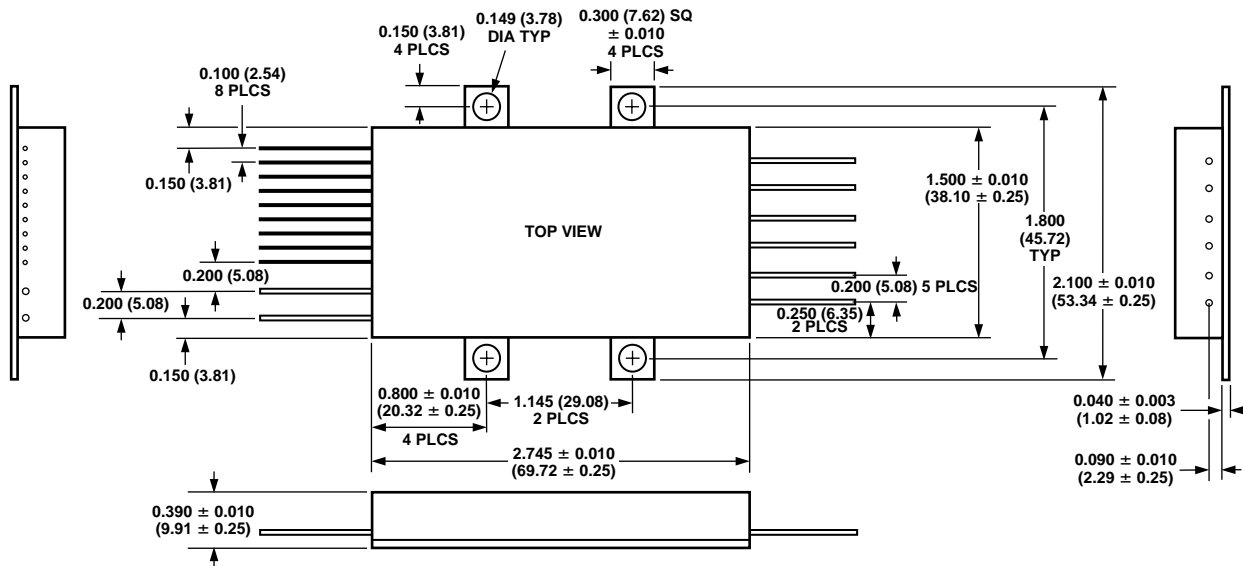

NOTES

- The final product weight is 85 grams maximum.
- The package base material is made of molybdenum and is nominally 40 mils (1.02 mm) thick. The "runout" is less than 2 mils per inch (0.02 mm per cm).
- The high current pins (10-17) are 40 mil (1.02 mm) diameter; are 99.8% copper; and are plated with gold over nickel.
- The signal carrying pins (1-9) are 18 mil (0.46 mm) diameter; are Kovar; and are plated with gold over nickel.
- All pins are a minimum length of 0.740 inches (18.80 mm) when the product is shipped. The pins are typically bent up or down and cut shorter for proper connection into the user's system.
- All pin-to-sidewall spacings are guaranteed for a minimum of 500 V dc breakdown at standard air pressure.
- The case outline was originally designed using the inch-pound units of measurement. In the event of conflict between the metric and inch-pound units, the inch-pound shall take precedence.

PRINTED IN U.S.A.