



# M24C64 M24C32

## 64Kbit and 32Kbit Serial I<sup>2</sup>C Bus EEPROM

### FEATURES SUMMARY

- Two-Wire I<sup>2</sup>C Serial Interface  
Supports 400kHz Protocol
- Single Supply Voltage:
  - 4.5 to 5.5V for M24Cxx
  - 2.5 to 5.5V for M24Cxx-W
  - 1.8 to 5.5V for M24Cxx-R
- Write Control Input
- BYTE and PAGE WRITE (up to 32 Bytes)
- RANDOM and SEQUENTIAL READ Modes
- Self-Timed Programming Cycle
- Automatic Address Incrementing
- Enhanced ESD/Latch-Up Protection
- More than 1 Million Erase/Write Cycles
- More than 40-Year Data Retention

Table 1. Product List

Reference	Part Number
M24C64	M24C64
	M24C64-W
	M24C64-R
M24C32	M24C32
	M24C32-W
	M24C32-R

Figure 1. Packages

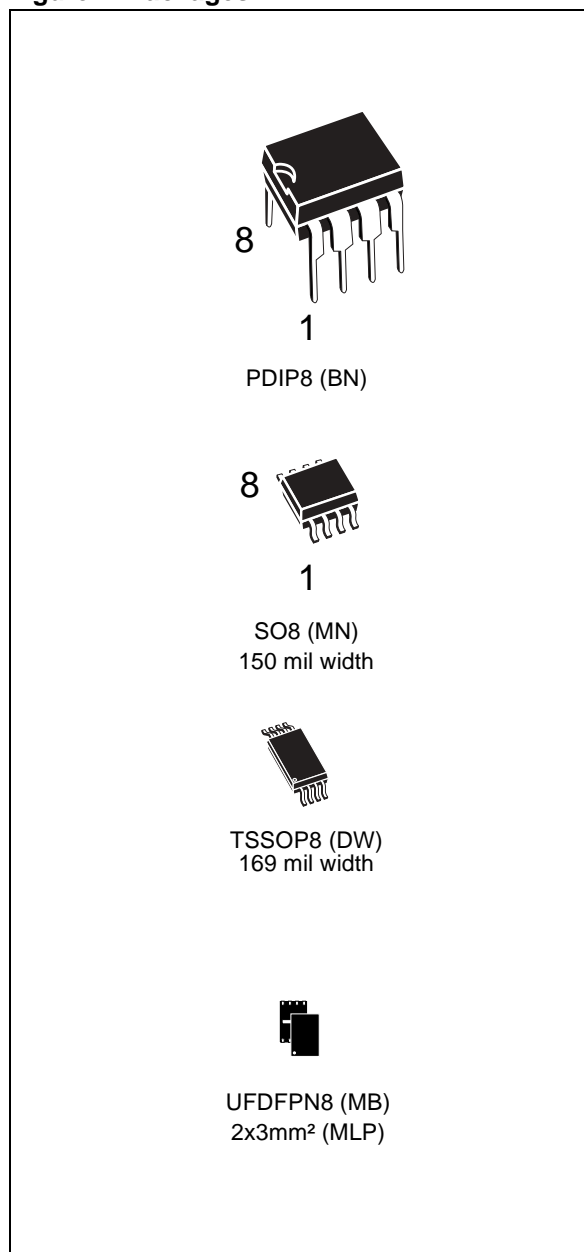

## TABLE OF CONTENTS

<b>FEATURES SUMMARY</b> .....	<b>1</b>
Table 1. Product List .....	1
Figure 1. Packages .....	1
<b>SUMMARY DESCRIPTION</b> .....	<b>4</b>
Figure 2. Logic Diagram .....	4
Table 2. Signal Names .....	4
<b>Power On Reset: VCC Lock-Out Write Protect</b> .....	<b>4</b>
Figure 3. DIP, SO, TSSOP and UDFPN Connections .....	4
<b>SIGNAL DESCRIPTION</b> .....	<b>5</b>
Serial Clock (SCL) .....	5
Serial Data (SDA) .....	5
Chip Enable ( $\overline{E0}$ , E1, E2) .....	5
Write Control ( $\overline{WC}$ ) .....	5
Figure 4. Maximum $R_L$ Value versus Bus Capacitance ( $C_{BUS}$ ) for an I <sup>2</sup> C Bus .....	5
Figure 5. I <sup>2</sup> C Bus Protocol .....	6
Table 3. Device Select Code .....	6
Table 4. Most Significant Byte .....	6
Table 5. Least Significant Byte .....	6
<b>MEMORY ORGANIZATION</b> .....	<b>7</b>
Figure 6. Block Diagram .....	7
<b>DEVICE OPERATION</b> .....	<b>8</b>
<b>Start Condition</b> .....	<b>8</b>
<b>Stop Condition</b> .....	<b>8</b>
<b>Acknowledge Bit (ACK)</b> .....	<b>8</b>
<b>Data Input</b> .....	<b>8</b>
<b>Memory Addressing</b> .....	<b>8</b>
Table 6. Operating Modes .....	8
Figure 7. Write Mode Sequences with $\overline{WC}=1$ (data write inhibited) .....	9
<b>Write Operations</b> .....	<b>9</b>
<b>Byte Write</b> .....	<b>9</b>
<b>Page Write</b> .....	<b>10</b>
Figure 8. Write Mode Sequences with $\overline{WC}=0$ (data write enabled) .....	10
Figure 9. Write Cycle Polling Flowchart using ACK .....	11
<b>Minimizing System Delays by Polling On ACK</b> .....	<b>11</b>
Figure 10. Read Mode Sequences .....	12
<b>Read Operations</b> .....	<b>12</b>
<b>Random Address Read</b> .....	<b>12</b>
<b>Current Address Read</b> .....	<b>12</b>
<b>Sequential Read</b> .....	<b>13</b>

<b>Acknowledge in Read Mode</b> .....	<b>13</b>
<b>INITIAL DELIVERY STATE</b> .....	<b>13</b>
<b>MAXIMUM RATING</b> .....	<b>14</b>
Table 7. Absolute Maximum Ratings .....	14
<b>DC AND AC PARAMETERS</b> .....	<b>15</b>
Table 8. Operating Conditions (M24Cxx-6) .....	15
Table 9. Operating Conditions (M24Cxx-W) .....	15
Table 10. Operating Conditions (M24Cxx-R) .....	15
Table 11. AC Measurement Conditions .....	16
Figure 11.AC Measurement I/O Waveform .....	16
Table 12. Input Parameters .....	16
Table 13. DC Characteristics (M24Cxx <sup>(1)</sup> , M24Cxx-W6 and M24Cxx-W3) .....	16
Table 14. DC Characteristics (M24Cxx-W6 and M24Cxx-W3) .....	17
Table 15. DC Characteristics (M24Cxx-R) .....	17
Table 16. AC Characteristics (M24Cxx-6, M24Cxx-W6 and M24Cxx-W3) .....	18
Table 17. AC Characteristics (M24Cxx-R) .....	18
Figure 12.AC Waveforms .....	19
<b>PACKAGE MECHANICAL</b> .....	<b>20</b>
Figure 13.PDIP8 – 8 pin Plastic DIP, 0.25mm lead frame, Package Outline .....	20
Table 18. PDIP8 – 8 pin Plastic DIP, 0.25mm lead frame, Package Mechanical Data .....	20
Figure 14.SO8 narrow – 8 lead Plastic Small Outline, 150 mils body width, Package Outline .....	21
Table 19. SO8 narrow – 8 lead Plastic Small Outline, 150 mils body width, Package Mechanical Data .....	21
Figure 15.TSSOP8 – 8 lead Thin Shrink Small Outline, Package Outline .....	22
Table 20. TSSOP8 – 8 lead Thin Shrink Small Outline, Package Mechanical Data .....	22
Figure 16.UFDFPN8 (MLP8) – 8-lead Ultra thin Fine pitch Dual Flat Package No lead 2x3mm. . .	23
Table 21. UFDFPN8 (MLP8) – 8-lead Ultra thin Fine pitch Dual Flat Package No lead 2x3mm, Package Mechanical Data .....	23
<b>PART NUMBERING</b> .....	<b>24</b>
Table 22. Ordering Information Scheme .....	24
<b>REVISION HISTORY</b> .....	<b>25</b>
Table 23. Document Revision History .....	25

### SUMMARY DESCRIPTION

These I<sup>2</sup>C-compatible electrically erasable programmable memory (EEPROM) devices are organized as 8192 x 8 bits (M24C64) and 4096 x 8 bits (M24C32).

Figure 2. Logic Diagram

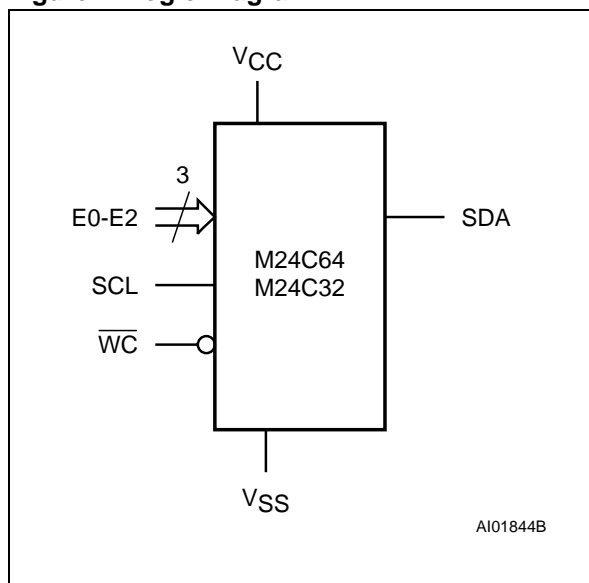

I<sup>2</sup>C uses a two-wire serial interface, comprising a bi-directional data line and a clock line. The devices carry a built-in 4-bit Device Type Identifier code (1010) in accordance with the I<sup>2</sup>C bus definition.

The device behaves as a slave in the I<sup>2</sup>C protocol, with all memory operations synchronized by the serial clock. Read and Write operations are initiated by a Start condition, generated by the bus master. The Start condition is followed by a Device Select Code and Read/Write bit (RW) (as described in Table 3.), terminated by an acknowledge bit.

When writing data to the memory, the device inserts an acknowledge bit during the 9<sup>th</sup> bit time, following the bus master's 8-bit transmission. When data is read by the bus master, the bus master acknowledges the receipt of the data byte in the same way. Data transfers are terminated by a Stop condition after an Ack for Write, and after a NoAck for Read.

Table 2. Signal Names

E0, E1, E2	Chip Enable
SDA	Serial Data
SCL	Serial Clock
WC	Write Control
VCC	Supply Voltage
VSS	Ground

#### Power On Reset: VCC Lock-Out Write Protect

In order to prevent data corruption and inadvertent Write operations during Power-up, a Power On Reset (POR) circuit is included. At Power-up, the internal reset is held active until VCC has reached the Power On Reset (POR) threshold voltage, and all operations are disabled – the device will not respond to any command. In the same way, when VCC drops from the operating voltage, below the Power On Reset (POR) threshold voltage, all operations are disabled and the device will not respond to any command.

A stable and valid VCC (as defined in Table 9. and Table 10.) must be applied before applying any logic signal.

Figure 3. DIP, SO, TSSOP and UDFPN Connections

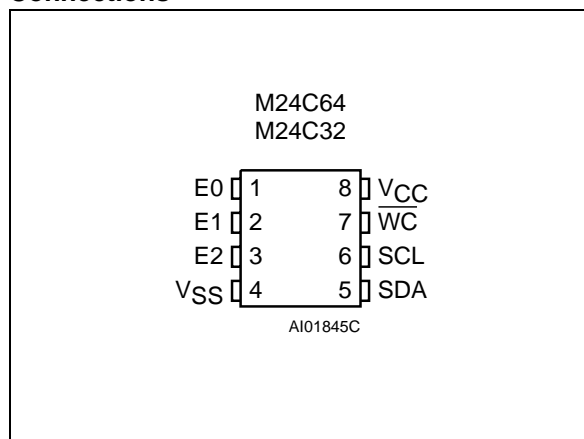

Note: See PACKAGE MECHANICAL section for package dimensions, and how to identify pin-1.

## SIGNAL DESCRIPTION

**Serial Clock (SCL).** This input signal is used to strobe all data in and out of the device. In applications where this signal is used by slave devices to synchronize the bus to a slower clock, the bus master must have an open drain output, and a pull-up resistor must be connected from Serial Clock (SCL) to  $V_{CC}$ . (Figure 4. indicates how the value of the pull-up resistor can be calculated). In most applications, though, this method of synchronization is not employed, and so the pull-up resistor is not necessary, provided that the bus master has a push-pull (rather than open drain) output.

**Serial Data (SDA).** This bi-directional signal is used to transfer data in or out of the device. It is an open drain output that may be wire-OR'ed with other open drain or open collector signals on the bus. A pull up resistor must be connected from Se-

rial Data (SDA) to  $V_{CC}$ . (Figure 4. indicates how the value of the pull-up resistor can be calculated).

**Chip Enable (E0, E1, E2).** These input signals are used to set the value that is to be looked for on the three least significant bits (b3, b2, b1) of the 7-bit Device Select Code. These inputs must be tied to  $V_{CC}$  or  $V_{SS}$ , to establish the Device Select Code.

**Write Control ( $\overline{WC}$ ).** This input signal is useful for protecting the entire contents of the memory from inadvertent write operations. Write operations are disabled to the entire memory array when Write Control ( $\overline{WC}$ ) is driven High. When unconnected, the signal is internally read as  $V_{IL}$ , and Write operations are allowed.

When Write Control ( $\overline{WC}$ ) is driven High, Device Select and Address bytes are acknowledged, Data bytes are not acknowledged.

Figure 4. Maximum  $R_L$  Value versus Bus Capacitance ( $C_{BUS}$ ) for an I<sup>2</sup>C Bus

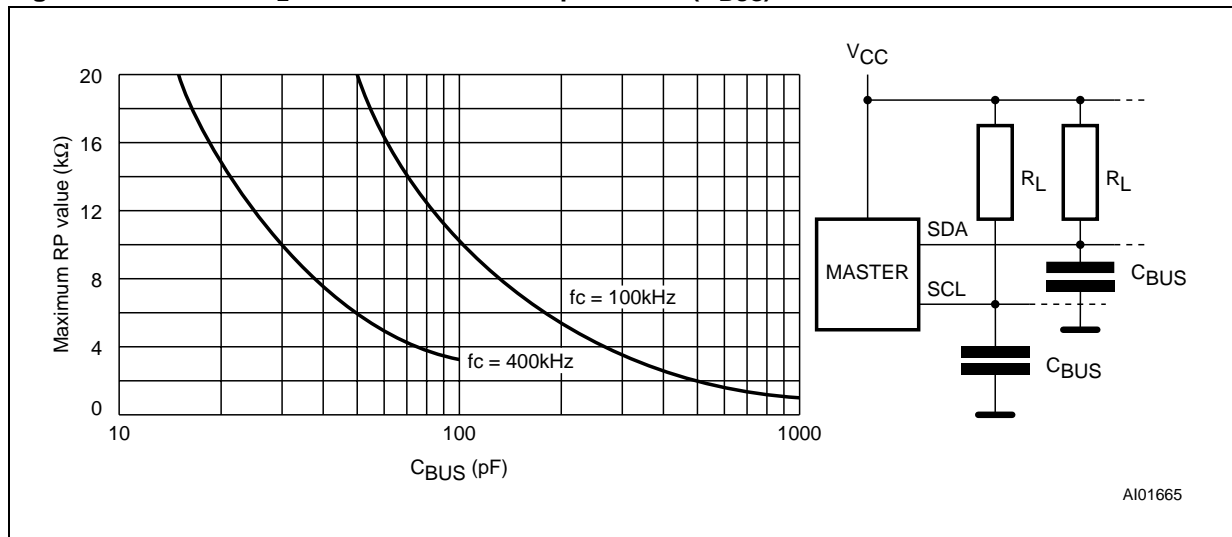

Figure 5. I<sup>2</sup>C Bus Protocol

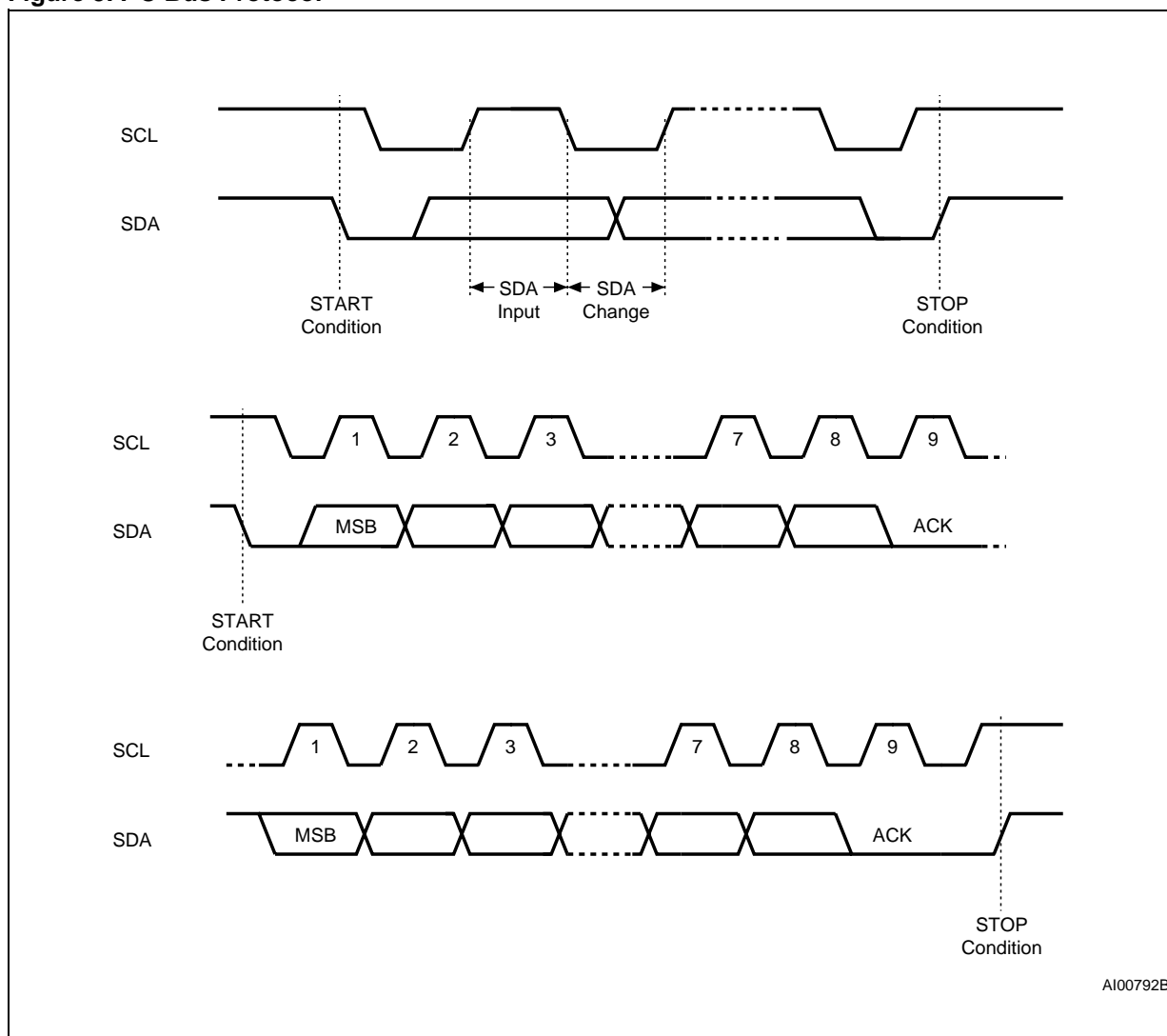

Table 3. Device Select Code

	Device Type Identifier <sup>1</sup>				Chip Enable Address <sup>2</sup>			R $\bar{W}$
	b7	b6	b5	b4	b3	b2	b1	b0
Device Select Code	1	0	1	0	E2	E1	E0	R $\bar{W}$

Note: 1. The most significant bit, b7, is sent first.

2. E0, E1 and E2 are compared against the respective external pins on the memory device.

Table 4. Most Significant Byte

b15	b14	b13	b12	b11	b10	b9	b8
-----	-----	-----	-----	-----	-----	----	----

Table 5. Least Significant Byte

b7	b6	b5	b4	b3	b2	b1	b0
----	----	----	----	----	----	----	----

## MEMORY ORGANIZATION

The memory is organized as shown in Figure 6..

Figure 6. Block Diagram

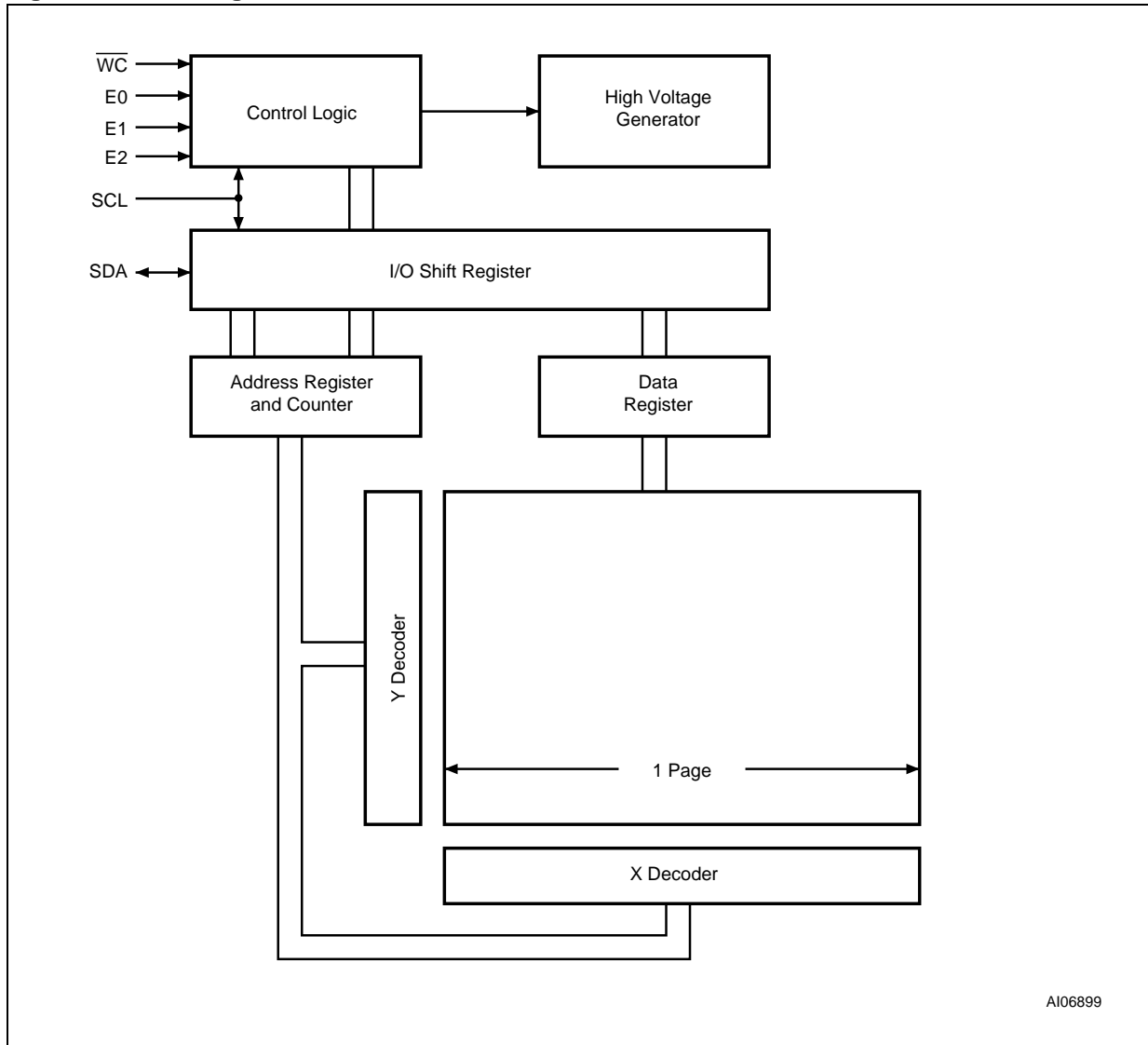

## DEVICE OPERATION

The device supports the I<sup>2</sup>C protocol. This is summarized in Figure 5. Any device that sends data on to the bus is defined to be a transmitter, and any device that reads the data to be a receiver. The device that controls the data transfer is known as the bus master, and the other as the slave device. A data transfer can only be initiated by the bus master, which will also provide the serial clock for synchronization. The M24Cxx device is always a slave in all communication.

### Start Condition

Start is identified by a falling edge of Serial Data (SDA) while Serial Clock (SCL) is stable in the High state. A Start condition must precede any data transfer command. The device continuously monitors (except during a Write cycle) Serial Data (SDA) and Serial Clock (SCL) for a Start condition, and will not respond unless one is given.

### Stop Condition

Stop is identified by a rising edge of Serial Data (SDA) while Serial Clock (SCL) is stable and driven High. A Stop condition terminates communication between the device and the bus master. A Read command that is followed by NoAck can be followed by a Stop condition to force the device into the Stand-by mode. A Stop condition at the end of a Write command triggers the internal Write cycle.

### Acknowledge Bit (ACK)

The acknowledge bit is used to indicate a successful byte transfer. The bus transmitter, whether it be bus master or slave device, releases Serial Data (SDA) after sending eight bits of data. During the 9<sup>th</sup> clock pulse period, the receiver pulls Serial

Data (SDA) Low to acknowledge the receipt of the eight data bits.

### Data Input

During data input, the device samples Serial Data (SDA) on the rising edge of Serial Clock (SCL). For correct device operation, Serial Data (SDA) must be stable during the rising edge of Serial Clock (SCL), and the Serial Data (SDA) signal must change *only* when Serial Clock (SCL) is driven Low.

### Memory Addressing

To start communication between the bus master and the slave device, the bus master must initiate a Start condition. Following this, the bus master sends the Device Select Code, shown in Table 3. (on Serial Data (SDA), most significant bit first).

The Device Select Code consists of a 4-bit Device Type Identifier, and a 3-bit Chip Enable "Address" (E2, E1, E0). To address the memory array, the 4-bit Device Type Identifier is 1010b.

Up to eight memory devices can be connected on a single I<sup>2</sup>C bus. Each one is given a unique 3-bit code on the Chip Enable (E0, E1, E2) inputs. When the Device Select Code is received, the device only responds if the Chip Enable Address is the same as the value on the Chip Enable (E0, E1, E2) inputs.

The 8<sup>th</sup> bit is the Read/Write bit ( $\overline{RW}$ ). This bit is set to 1 for Read and 0 for Write operations.

If a match occurs on the Device Select code, the corresponding device gives an acknowledgment on Serial Data (SDA) during the 9<sup>th</sup> bit time. If the device does not match the Device Select code, it deselected itself from the bus, and goes into Stand-by mode.

Table 6. Operating Modes

Mode	$\overline{RW}$ bit	$\overline{WC}$ <sup>1</sup>	Bytes	Initial Sequence
Current Address Read	1	X	1	START, Device Select, $\overline{RW} = 1$
Random Address Read	0	X	1	START, Device Select, $\overline{RW} = 0$ , Address
	1	X		reSTART, Device Select, $\overline{RW} = 1$
Sequential Read	1	X	≥ 1	Similar to Current or Random Address Read
Byte Write	0	V <sub>IL</sub>	1	START, Device Select, $\overline{RW} = 0$
Page Write	0	V <sub>IL</sub>	≤ 32	START, Device Select, $\overline{RW} = 0$

Note: 1. X = V<sub>IH</sub> or V<sub>IL</sub>.

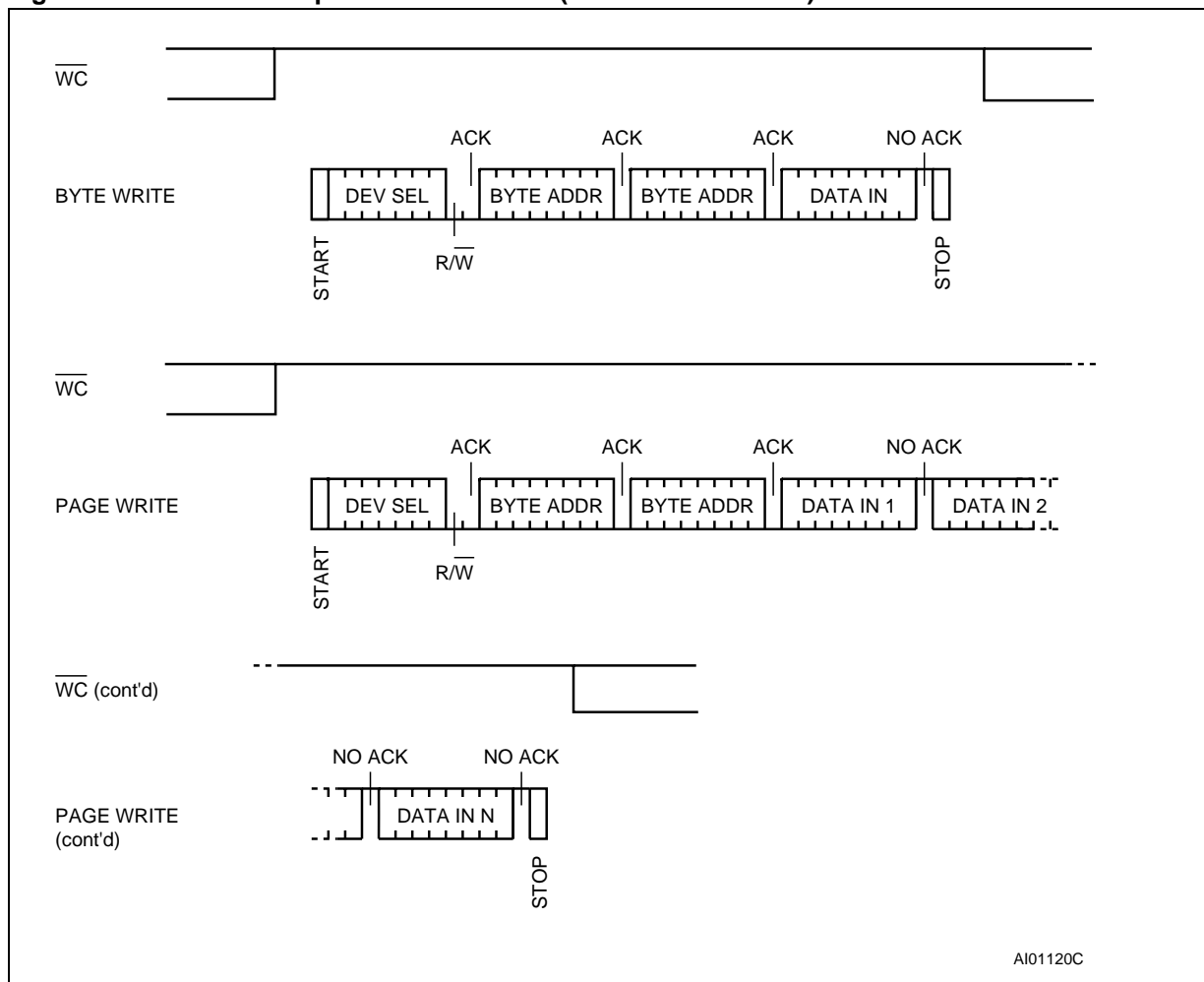

Figure 7. Write Mode Sequences with  $\overline{WC}=1$  (data write inhibited)

### Write Operations

Following a Start condition the bus master sends a Device Select Code with the Read/Write bit ( $\overline{R/W}$ ) reset to 0. The device acknowledges this, as shown in Figure 8., and waits for two address bytes. The device responds to each address byte with an acknowledge bit, and then waits for the data byte.

Writing to the memory may be inhibited if Write Control ( $\overline{WC}$ ) is driven High. Any Write instruction with Write Control ( $\overline{WC}$ ) driven High (during a period of time from the Start condition until the end of the two address bytes) will not modify the memory contents, and the accompanying data bytes are *not* acknowledged, as shown in Figure 7..

Each data byte in the memory has a 16-bit (two byte wide) address. The Most Significant Byte (Table 4.) is sent first, followed by the Least Significant Byte (Table 5.). Bits b15 to b0 form the address of the byte in memory.

When the bus master generates a Stop condition immediately after the Ack bit (in the "10<sup>th</sup> bit" time

slot), either at the end of a Byte Write or a Page Write, the internal Write cycle is triggered. A Stop condition at any other time slot does not trigger the internal Write cycle.

After the Stop condition, the delay  $t_W$ , and the successful completion of a Write operation, the device's internal address counter is incremented automatically, to point to the next byte address after the last one that was modified.

During the internal Write cycle, Serial Data (SDA) is disabled internally, and the device does not respond to any requests.

### Byte Write

After the Device Select code and the address bytes, the bus master sends one data byte. If the addressed location is Write-protected, by Write Control ( $\overline{WC}$ ) being driven High, the device replies with NoAck, and the location is not modified. If, instead, the addressed location is not Write-protected, the device replies with Ack. The bus master terminates the transfer by generating a Stop condition, as shown in Figure 8..

**Page Write**

The Page Write mode allows up to 32 bytes to be written in a single Write cycle, provided that they are all located in the same 'row' in the memory: that is, the most significant memory address bits (b12-b5 for M24C64, and b11-b5 for M24C32) are the same. If more bytes are sent than will fit up to the end of the row, a condition known as 'roll-over' occurs. This should be avoided, as data starts to become overwritten in an implementation dependent way.

The bus master sends from 1 to 32 bytes of data, each of which is acknowledged by the device if Write Control ( $\overline{WC}$ ) is Low. If Write Control ( $\overline{WC}$ ) is High, the contents of the addressed memory location are not modified, and each data byte is followed by a NoAck. After each byte is transferred, the internal byte address counter (the 5 least significant address bits only) is incremented. The transfer is terminated by the bus master generating a Stop condition.

**Figure 8. Write Mode Sequences with  $\overline{WC}=0$  (data write enabled)**

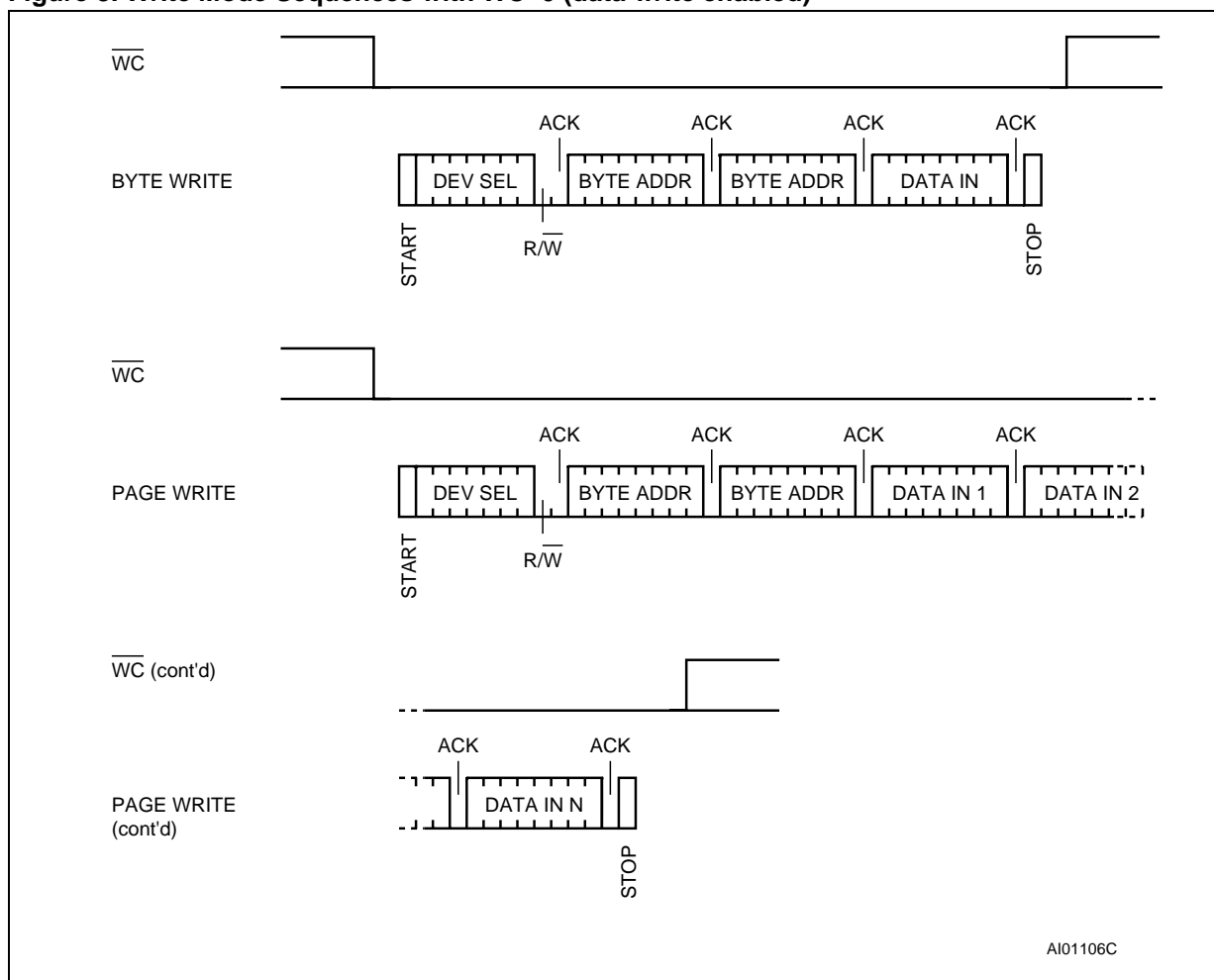
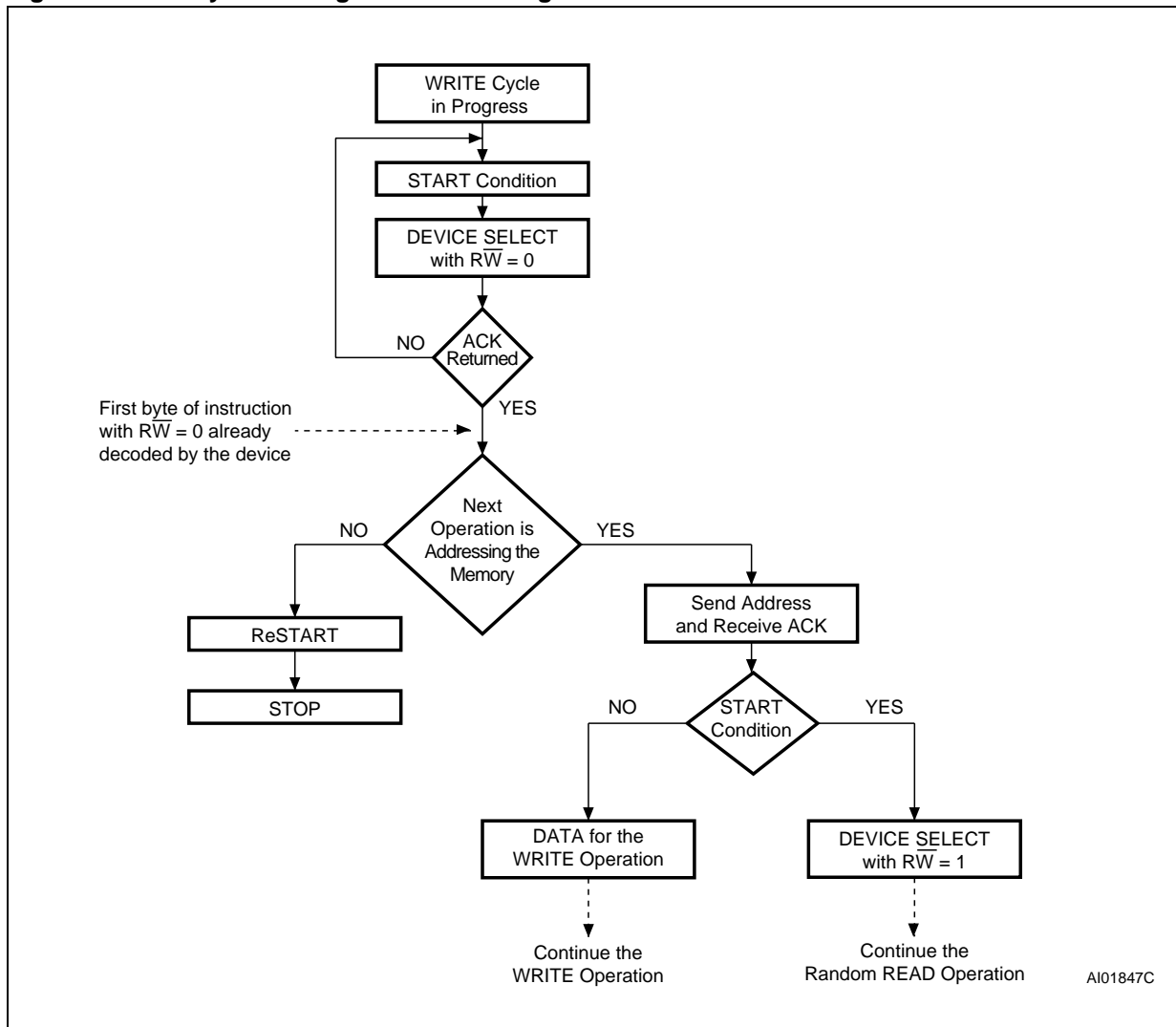

Figure 9. Write Cycle Polling Flowchart using ACK



### Minimizing System Delays by Polling On ACK

During the internal Write cycle, the device disconnects itself from the bus, and writes a copy of the data from its internal latches to the memory cells. The maximum Write time ( $t_w$ ) is shown in Table 16. and Table 17., but the typical time is shorter. To make use of this, a polling sequence can be used by the bus master.

The sequence, as shown in Figure 9., is:

- Initial condition: a Write cycle is in progress.
- Step 1: the bus master issues a Start condition followed by a Device Select Code (the first byte of the new instruction).
- Step 2: if the device is busy with the internal Write cycle, no Ack will be returned and the bus master goes back to Step 1. If the device has terminated the internal Write cycle, it responds with an Ack, indicating that the device is ready to receive the second part of the instruction (the first byte of this instruction having been sent during Step 1).

Figure 10. Read Mode Sequences

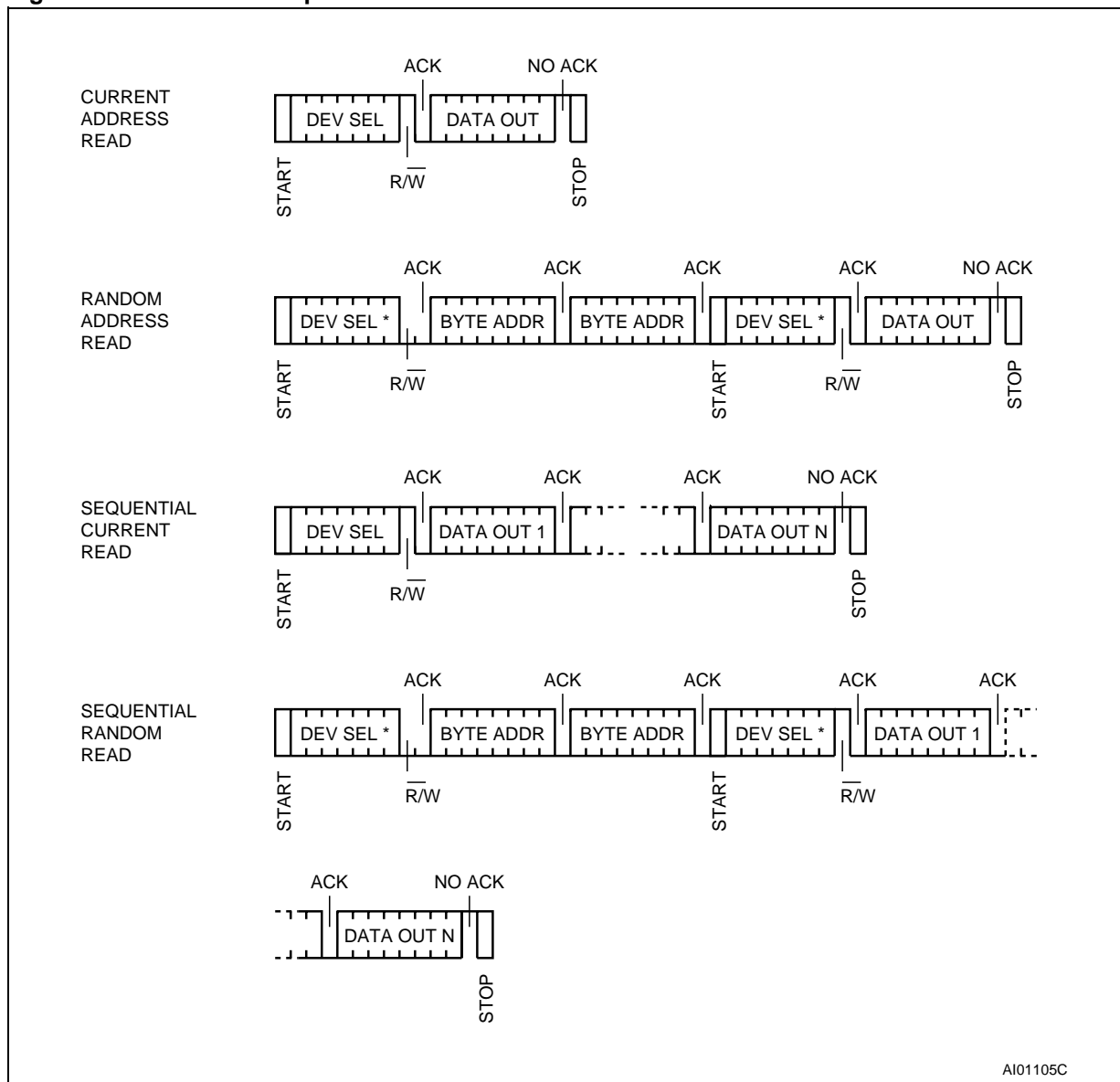

AI01105C

Note: 1. The seven most significant bits of the Device Select Code of a Random Read (in the 1<sup>st</sup> and 4<sup>th</sup> bytes) must be identical.

**Read Operations**

Read operations are performed independently of the state of the Write Control (WC) signal.

After the successful completion of a Read operation, the device's internal address counter is incremented by one, to point to the next byte address.

**Random Address Read**

A dummy Write is first performed to load the address into this address counter (as shown in Figure 10.) but *without* sending a Stop condition. Then, the bus master sends another Start condition, and repeats the Device Select Code, with the Read/Write bit (RW) set to 1. The device acknowledges this, and outputs the contents of the ad-

ressed byte. The bus master must *not* acknowledge the byte, and terminates the transfer with a Stop condition.

**Current Address Read**

For the Current Address Read operation, following a Start condition, the bus master only sends a Device Select Code with the Read/Write bit (RW) set to 1. The device acknowledges this, and outputs the byte addressed by the internal address counter. The counter is then incremented. The bus master terminates the transfer with a Stop condition, as shown in Figure 10., *without* acknowledging the byte.



**Sequential Read**

This operation can be used after a Current Address Read or a Random Address Read. The bus master *does* acknowledge the data byte output, and sends additional clock pulses so that the device continues to output the next byte in sequence. To terminate the stream of bytes, the bus master must *not* acknowledge the last byte, and *must* generate a Stop condition, as shown in [Figure 10](#).

The output data comes from consecutive addresses, with the internal address counter automatically incremented after each byte output. After the last memory address, the address counter 'rolls-over', and the device continues to output data from memory address 00h.

**Acknowledge in Read Mode**

For all Read commands, the device waits, after each byte read, for an acknowledgment during the 9<sup>th</sup> bit time. If the bus master does not drive Serial Data (SDA) Low during this time, the device terminates the data transfer and switches to its Standby mode.

**INITIAL DELIVERY STATE**

The device is delivered with all bits in the memory array set to 1 (each byte contains FFh).

**MAXIMUM RATING**

Stressing the device outside the ratings listed in [Table 7](#), may cause permanent damage to the device. These are stress ratings only, and operation of the device at these, or any other conditions outside those indicated in the Operating sections of

this specification, is not implied. Exposure to Absolute Maximum Rating conditions for extended periods may affect device reliability. Refer also to the STMicroelectronics SURE Program and other relevant quality documents.

**Table 7. Absolute Maximum Ratings**

Symbol	Parameter	Min.	Max.	Unit
T <sub>STG</sub>	Storage Temperature	-65	150	°C
T <sub>LEAD</sub>	Lead Temperature during Soldering	See note <sup>1</sup>		°C
V <sub>IO</sub>	Input or Output range	-0.50	6.5	V
V <sub>CC</sub>	Supply Voltage	-0.50	6.5	V
V <sub>ESD</sub>	Electrostatic Discharge Voltage (Human Body model) <sup>2</sup>	-4000	4000	V

Note: 1. Compliant with JEDEC Std J-STD-020B (for small body, Sn-Pb or Pb assembly), the ST ECOPACK<sup>®</sup> 7191395 specification, and the European directive on Restrictions on Hazardous Substances (RoHS) 2002/95/EU

2. AEC-Q100-002 (compliant with JEDEC Std JESD22-A114A, C1=100pF, R1=1500Ω, R2=500Ω)

## DC AND AC PARAMETERS

This section summarizes the operating and measurement conditions, and the DC and AC characteristics of the device. The parameters in the DC and AC Characteristic tables that follow are derived from tests performed under the Measure-

ment Conditions summarized in the relevant tables. Designers should check that the operating conditions in their circuit match the measurement conditions when relying on the quoted parameters.

**Table 8. Operating Conditions (M24Cxx-6)**

Symbol	Parameter	Min.	Max.	Unit
$V_{CC}$	Supply Voltage <sup>1</sup>	4.5	5.5	V
$T_A$	Ambient Operating Temperature	-40	85	°C

Note: 1. This range is Not for New Design, and will soon be replaced by the M24Cxx-W range.

**Table 9. Operating Conditions (M24Cxx-W)**

Symbol	Parameter	Min.	Max.	Unit
$V_{CC}$	Supply Voltage	2.5	5.5	V
$T_A$	Ambient Operating Temperature (Device Grade 6)	-40	85	°C
	Ambient Operating Temperature (Device Grade 3)	-40	125	°C

**Table 10. Operating Conditions (M24Cxx-R)**

Symbol	Parameter	Min.	Max.	Unit
$V_{CC}$	Supply Voltage	1.8	5.5	V
$T_A$	Ambient Operating Temperature	-40	85	°C

## M24C64, M24C32

**Table 11. AC Measurement Conditions**

Symbol	Parameter	Min.	Max.	Unit
$C_L$	Load Capacitance	100		pF
	Input Rise and Fall Times		50	ns
	Input Levels	0.2V <sub>CC</sub> to 0.8V <sub>CC</sub>		V
	Input and Output Timing Reference Levels	0.3V <sub>CC</sub> to 0.7V <sub>CC</sub>		V

**Figure 11. AC Measurement I/O Waveform**

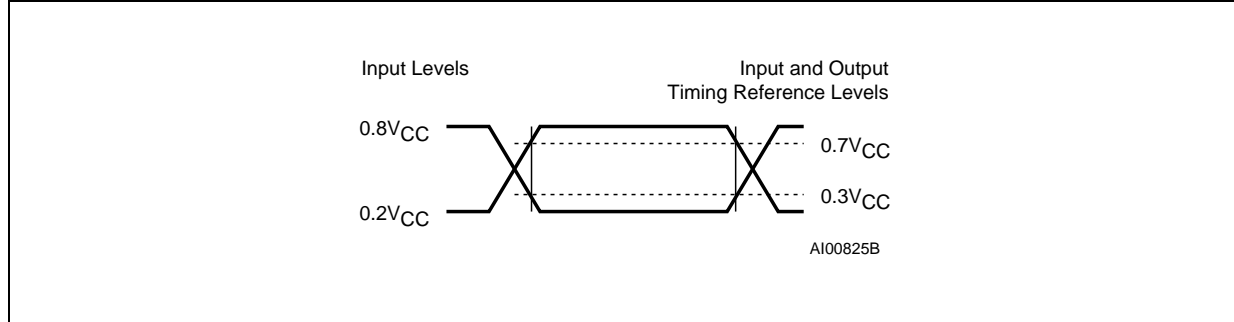

**Table 12. Input Parameters**

Symbol	Parameter <sup>1,2</sup>	Test Condition	Min.	Max.	Unit
$C_{IN}$	Input Capacitance (SDA)			8	pF
$C_{IN}$	Input Capacitance (other pins)			6	pF
$Z_{WCL}$	$\overline{WC}$ Input Impedance	$V_{IN} < 0.3V_{CC}$	50	200	k $\Omega$
$Z_{WCH}$	$\overline{WC}$ Input Impedance	$V_{IN} > 0.7V_{CC}$	500		k $\Omega$
$t_{NS}$	Pulse width ignored (Input Filter on SCL and SDA)			200	ns

Note: 1.  $T_A = 25^\circ\text{C}$ ,  $f = 400\text{kHz}$   
 2. Sampled only, not 100% tested.

**Table 13. DC Characteristics (M24Cxx<sup>(1)</sup>, M24Cxx-W6 and M24Cxx-W3)**

Symbol	Parameter	Test Condition (in addition to those in Table 8.)	Min.	Max.	Unit
$I_{LI}$	Input Leakage Current (SCL, SDA, E2, E1, E0)	$V_{IN} = V_{SS}$ or $V_{CC}$ device in Stand-by mode		$\pm 2$	$\mu\text{A}$
$I_{LO}$	Output Leakage Current	$V_{OUT} = V_{SS}$ or $V_{CC}$ , SDA in Hi-Z		$\pm 2$	$\mu\text{A}$
$I_{CC}$	Supply Current	$V_{CC}=5\text{V}$ , $f_c=400\text{kHz}$ (rise/fall time < 30ns)		2	mA
$I_{CC1}$	Stand-by Supply Current	$V_{IN} = V_{SS}$ or $V_{CC}$ , $V_{CC} = 5\text{V}$		10	$\mu\text{A}$
$V_{IL}$	Input Low Voltage		-0.45	0.3V <sub>CC</sub>	V
$V_{IH}$	Input High Voltage		0.7V <sub>CC</sub>	$V_{CC}+1$	V
$V_{OL}$	Output Low Voltage	$I_{OL} = 3\text{mA}$ , $V_{CC} = 5\text{V}$		0.4	V

Note: 1. This range is Not for New Design, and will soon be replaced by the M24Cxx-W range.



Table 14. DC Characteristics (M24Cxx-W6 and M24Cxx-W3)

Symbol	Parameter	Test Condition (in addition to those in Table 9.)	Min.	Max.	Unit
$I_{LI}$	Input Leakage Current (SCL, SDA, E2, E1, E0)	$V_{IN} = V_{SS}$ or $V_{CC}$ device in Stand-by mode		$\pm 2$	$\mu A$
$I_{LO}$	Output Leakage Current	$V_{OUT} = V_{SS}$ or $V_{CC}$ , SDA in Hi-Z		$\pm 2$	$\mu A$
$I_{CC}$	Supply Current	$V_{CC} = 2.5V$ , $f_c = 400kHz$ (rise/fall time < 30ns)		1	mA
$I_{CC1}$	Stand-by Supply Current	$V_{IN} = V_{SS}$ or $V_{CC}$ , $V_{CC} = 2.5 V$		2	$\mu A$
$V_{IL}$	Input Low Voltage		-0.45	$0.3V_{CC}$	V
$V_{IH}$	Input High Voltage		$0.7V_{CC}$	$V_{CC}+1$	V
$V_{OL}$	Output Low Voltage	$I_{OL} = 2.1 mA$ , $V_{CC} = 2.5 V$		0.4	V

Table 15. DC Characteristics (M24Cxx-R)

Symbol	Parameter	Test Condition (in addition to those in Table 10.)	Min.	Max.	Unit
$I_{LI}$	Input Leakage Current (SCL, SDA, E2, E1, E0)	$V_{IN} = V_{SS}$ or $V_{CC}$ device in Stand-by mode		$\pm 2$	$\mu A$
$I_{LO}$	Output Leakage Current	$V_{OUT} = V_{SS}$ or $V_{CC}$ , SDA in Hi-Z		$\pm 2$	$\mu A$
$I_{CC}$	Supply Current	$V_{CC} = 1.8V$ , $f_c = 100kHz$ (rise/fall time < 30ns)		0.8	mA
$I_{CC1}$	Stand-by Supply Current	$V_{IN} = V_{SS}$ or $V_{CC}$ , $V_{CC} = 1.8 V$		0.2	$\mu A$
$V_{IL}$	Input Low Voltage		-0.45	$0.3 V_{CC}$	V
$V_{IH}$	Input High Voltage		$0.7V_{CC}$	$V_{CC}+1$	V
$V_{OL}$	Output Low Voltage	$I_{OL} = 0.7 mA$ , $V_{CC} = 1.8 V$		0.2	V

## M24C64, M24C32

**Table 16. AC Characteristics (M24Cxx-6, M24Cxx-W6 and M24Cxx-W3)**

Test conditions specified in Table 11. and Table 8. or Table 9.					
Symbol	Alt.	Parameter	Min.	Max.	Unit
$f_c$	$f_{SCL}$	Clock Frequency		400	kHz
$t_{CHCL}$	$t_{HIGH}$	Clock Pulse Width High	600		ns
$t_{CLCH}$	$t_{LOW}$	Clock Pulse Width Low	1300		ns
$t_{DL1DL2}^2$	$t_F$	SDA Fall Time	20	300	ns
$t_{DXCX}$	$t_{SU:DAT}$	Data In Set Up Time	100		ns
$t_{CLDX}$	$t_{HD:DAT}$	Data In Hold Time	0		ns
$t_{CLQX}$	$t_{DH}$	Data Out Hold Time	200		ns
$t_{CLQV}^3$	$t_{AA}$	Clock Low to Next Data Valid (Access Time)	200	900	ns
$t_{CHDX}^1$	$t_{SU:STA}$	Start Condition Set Up Time	600		ns
$t_{DLCL}$	$t_{HD:STA}$	Start Condition Hold Time	600		ns
$t_{CHDH}$	$t_{SU:STO}$	Stop Condition Set Up Time	600		ns
$t_{DHDL}$	$t_{BUF}$	Time between Stop Condition and Next Start Condition	1300		ns
$t_W$	$t_{WR}$	Write Time		5 or <sup>4</sup> 10	ms

Note: 1. For a reSTART condition, or following a Write cycle.

2. Sampled only, not 100% tested.

3. To avoid spurious START and STOP conditions, a minimum delay is placed between SCL=1 and the falling or rising edge of SDA.

4. The Write Time of 5 ms only applies to devices bearing the process letter "B" in the package marking (on the top side of the package), otherwise (for devices bearing the process letter "N") the Write Time is 10 ms. For further details, please contact your nearest ST sales office, and ask for a copy of the Product Change Notice PCEE0036.

**Table 17. AC Characteristics (M24Cxx-R)**

Test conditions specified in Table 11. and Table 10.					
Symbol	Alt.	Parameter	Min.	Max.	Unit
$f_c$	$f_{SCL}$	Clock Frequency		400	kHz
$t_{CHCL}$	$t_{HIGH}$	Clock Pulse Width High	600		ns
$t_{CLCH}$	$t_{LOW}$	Clock Pulse Width Low	1300		ns
$t_{DL1DL2}^2$	$t_F$	SDA Fall Time	20	300	ns
$t_{DXCX}$	$t_{SU:DAT}$	Data In Set Up Time	100		ns
$t_{CLDX}$	$t_{HD:DAT}$	Data In Hold Time	0		ns
$t_{CLQX}$	$t_{DH}$	Data Out Hold Time	200		ns
$t_{CLQV}^3$	$t_{AA}$	Clock Low to Next Data Valid (Access Time)	200	900	ns
$t_{CHDX}^1$	$t_{SU:STA}$	Start Condition Set Up Time	600		ns
$t_{DLCL}$	$t_{HD:STA}$	Start Condition Hold Time	600		ns
$t_{CHDH}$	$t_{SU:STO}$	Stop Condition Set Up Time	600		ns
$t_{DHDL}$	$t_{BUF}$	Time between Stop Condition and Next Start Condition	1300		ns
$t_W$	$t_{WR}$	Write Time		10	ms

Note: 1. For a reSTART condition, or following a Write cycle.

2. Sampled only, not 100% tested.

3. To avoid spurious START and STOP conditions, a minimum delay is placed between SCL=1 and the falling or rising edge of SDA.

Figure 12. AC Waveforms

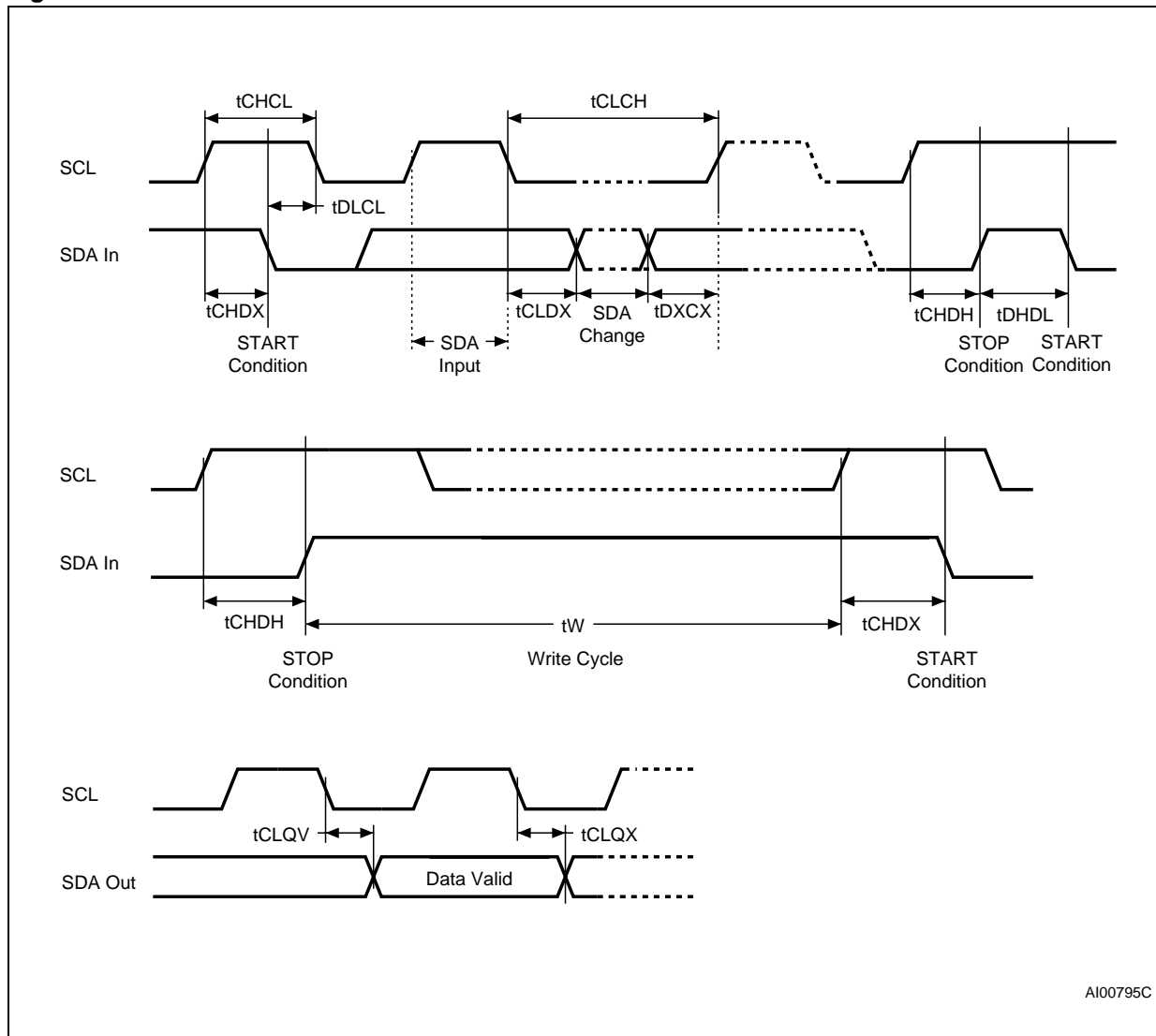

**PACKAGE MECHANICAL**

**Figure 13. PDIP8 – 8 pin Plastic DIP, 0.25mm lead frame, Package Outline**



Note: Drawing is not to scale.

**Table 18. PDIP8 – 8 pin Plastic DIP, 0.25mm lead frame, Package Mechanical Data**

Symbol	millimeters			inches		
	Typ.	Min.	Max.	Typ.	Min.	Max.
A			5.33			0.210
A1		0.38			0.015	
A2	3.30	2.92	4.95	0.130	0.115	0.195
b	0.46	0.36	0.56	0.018	0.014	0.022
b2	1.52	1.14	1.78	0.060	0.045	0.070
c	0.25	0.20	0.36	0.010	0.008	0.014
D	9.27	9.02	10.16	0.365	0.355	0.400
E	7.87	7.62	8.26	0.310	0.300	0.325
E1	6.35	6.10	7.11	0.250	0.240	0.280
e	2.54	–	–	0.100	–	–
eA	7.62	–	–	0.300	–	–
eB			10.92			0.430
L	3.30	2.92	3.81	0.130	0.115	0.150

Figure 14. SO8 narrow – 8 lead Plastic Small Outline, 150 mils body width, Package Outline

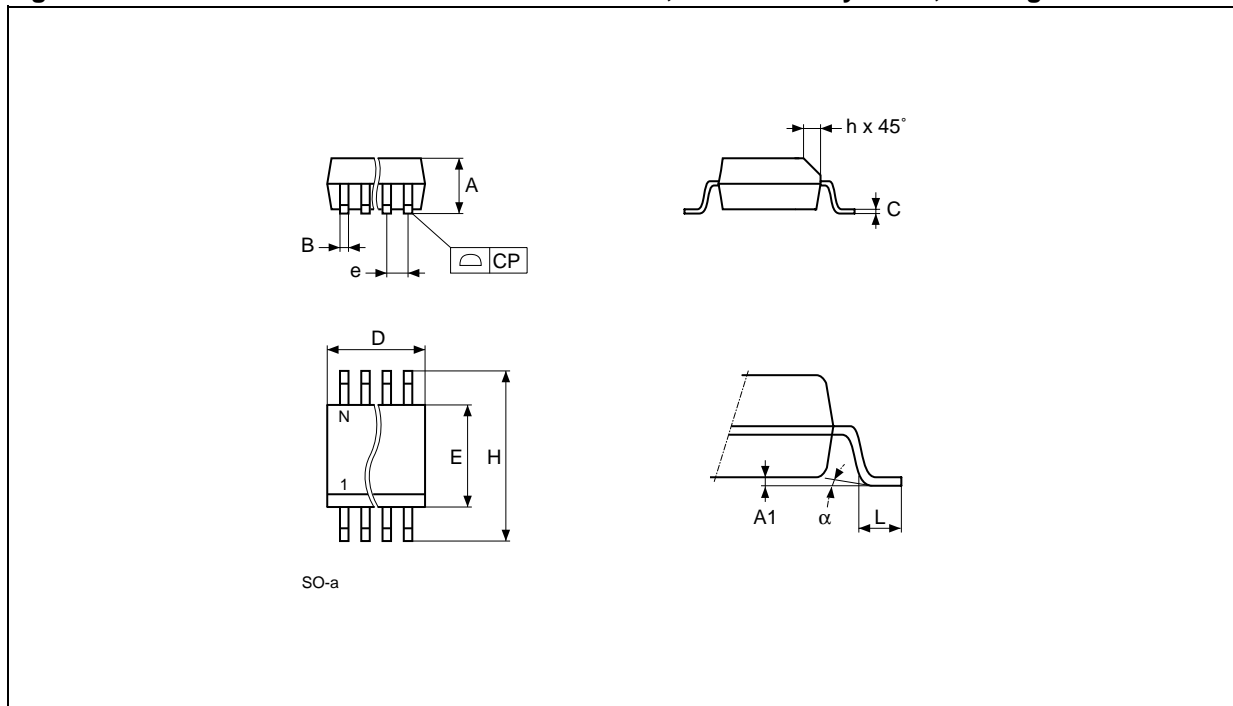

Note: Drawing is not to scale.

Table 19. SO8 narrow – 8 lead Plastic Small Outline, 150 mils body width, Package Mechanical Data

Symbol	millimeters			inches			
	Typ.	Min.	Max.	Typ.	Min.	Max.	
A		1.35	1.75		0.053	0.069	
A1		0.10	0.25		0.004	0.010	
B		0.33	0.51		0.013	0.020	
C		0.19	0.25		0.007	0.010	
D		4.80	5.00		0.189	0.197	
E		3.80	4.00		0.150	0.157	
e	1.27	–	–	0.050	–	–	
H		5.80	6.20		0.228	0.244	
h		0.25	0.50		0.010	0.020	
L		0.40	0.90		0.016	0.035	
$\alpha$		0°	8°		0°	8°	
N		8				8	
CP			0.10			0.004	

Figure 15. TSSOP8 – 8 lead Thin Shrink Small Outline, Package Outline



Note: Drawing is not to scale.

Table 20. TSSOP8 – 8 lead Thin Shrink Small Outline, Package Mechanical Data

Symbol	mm			inches		
	Typ.	Min.	Max.	Typ.	Min.	Max.
A			1.200			0.0472
A1		0.050	0.150		0.0020	0.0059
A2	1.000	0.800	1.050	0.0394	0.0315	0.0413
b		0.190	0.300		0.0075	0.0118
c		0.090	0.200		0.0035	0.0079
CP			0.100			0.0039
D	3.000	2.900	3.100	0.1181	0.1142	0.1220
e	0.650	–	–	0.0256	–	–
E	6.400	6.200	6.600	0.2520	0.2441	0.2598
E1	4.400	4.300	4.500	0.1732	0.1693	0.1772
L	0.600	0.450	0.750	0.0236	0.0177	0.0295
L1	1.000			0.0394		
α		0°	8°		0°	8°

Figure 16. UFDFPN8 (MLP8) – 8-lead Ultra thin Fine pitch Dual Flat Package No lead 2x3mm

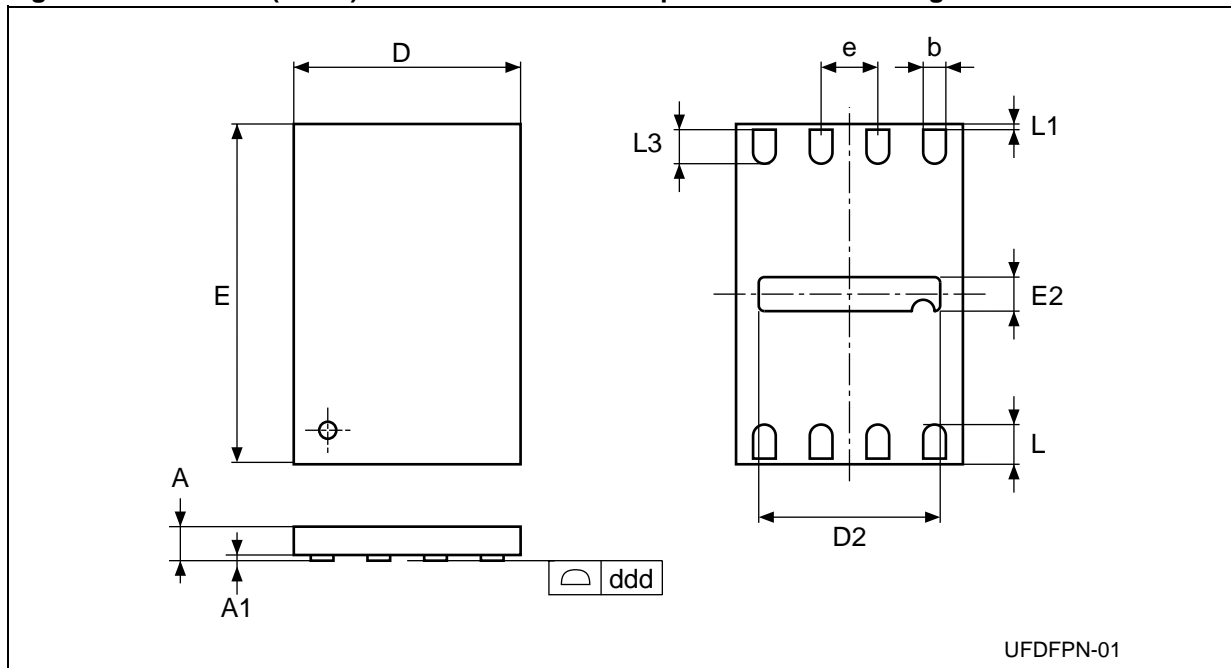

Note: Drawing is not to scale.

Table 21. UFDFPN8 (MLP8) – 8-lead Ultra thin Fine pitch Dual Flat Package No lead 2x3mm, Package Mechanical Data

Symbol	millimeters			inches		
	Typ	Min	Max	Typ	Min	Max
A	0.55	0.50	0.60	0.022	0.020	0.024
A1		0.00	0.05		0.000	0.002
b	0.25	0.20	0.30	0.010	0.008	0.012
D	2.00			0.079		
D2		1.55	1.65		0.061	0.065
ddd			0.05			0.002
E	3.00			0.118		
E2		0.15	0.25		0.006	0.010
e	0.50	–	–	0.020	–	–
L	0.45	0.40	0.50	0.018	0.016	0.020
L1			0.15			0.006
L3		0.30			0.012	
N	8			8		

**PART NUMBERING**

**Table 22. Ordering Information Scheme**

Example:	M24C32	-	W	MN	6	T	P
<b>Device Type</b>							
M24 = I <sup>2</sup> C serial access EEPROM							
<b>Device Function</b>							
64 = 64 Kbit (8192 x 8) 32 = 32 Kbit (4096 x 8)							
<b>Operating Voltage</b>							
blank <sup>(2)</sup> = V <sub>CC</sub> = 4.5 to 5.5V W = V <sub>CC</sub> = 2.5 to 5.5V R = V <sub>CC</sub> = 1.8 to 5.5V							
<b>Package</b>							
BN = PDIP8 MN = SO8 (150 mil width) DW = TSSOP8 (169 mil width) MB = UFDFPN8 (MLP8) <sup>(3)</sup>							
<b>Device Grade</b>							
6 = Industrial: device tested with standard test flow over -40 to 85 °C 3 = Automotive: device tested with High Reliability Certified Flow <sup>(1)</sup> over -40 to 125 °C.							
<b>Option</b>							
blank = Standard Packing T = Tape and Reel Packing							
<b>Plating Technology</b>							
blank = Standard SnPb plating P or G = RoHS compliant							

Note: 1. ST strongly recommends the use of the Automotive Grade devices for use in an automotive environment. The High Reliability Certified Flow (HRCF) is described in the quality note QNEE9801. Please ask your nearest ST sales office for a copy.  
 2. This range is Not for New Design, and will soon be replaced by the M24Cxx-W range.  
 3. The UFDFPN8 package is available in M24C32 devices only. It is not available in M24C64 devices.

For a list of available options (speed, package, etc.) or for further information on any aspect of this device, please contact your nearest ST Sales Office.



## REVISION HISTORY

**Table 23. Document Revision History**

Date	Rev.	Description of Revision
22-Dec-1999	2.3	TSSOP8 package in place of TSSOP14 (pp 1, 2, OrderingInfo, PackageMechData).
28-Jun-2000	2.4	TSSOP8 package data corrected
31-Oct-2000	2.5	References to Temperature Range 3 removed from Ordering Information Voltage range -S added, and range -R removed from text and tables throughout.
20-Apr-2001	2.6	Lead Soldering Temperature in the Absolute Maximum Ratings table amended Write Cycle Polling Flow Chart using ACK illustration updated References to PSDIP changed to PDIP and Package Mechanical data updated
16-Jan-2002	2.7	Test condition for $I_{LI}$ made more precise, and value of $I_{LI}$ for E2-E0 and $\overline{WC}$ added -R voltage range added
02-Aug-2002	2.8	Document reformatted using new template. TSSOP8 (3x3mm <sup>2</sup> body size) package (MSOP8) added. 5ms write time offered for 5V and 2.5V devices
04-Feb-2003	2.9	SO8W package removed. -S voltage range removed
27-May-2003	2.10	TSSOP8 (3x3mm <sup>2</sup> body size) package (MSOP8) removed
22-Oct-2003	3.0	Table of contents, and Pb-free options added. Minor wording changes in Summary Description, Power-On Reset, Memory Addressing, Write Operations, Read Operations. $V_{IL}(\min)$ improved to -0.45V.
01-Jun-2004	4.0	Absolute Maximum Ratings for $V_{IO}(\min)$ and $V_{CC}(\min)$ improved. Soldering temperature information clarified for RoHS compliant devices. Device Grade clarified
04-Nov-2004	5.0	Product List summary table added. Device Grade 3 added. 4.5-5.5V range is Not for New Design. Some minor wording changes. AEC-Q100-002 compliance. $t_{NS}(\max)$ changed. $V_{IL}(\min)$ is the same on all input pins of the device. $Z_{WCL}$ changed.
05-Jan-2005	6.0	UFDFPN8 package added. Small text changes.

Information furnished is believed to be accurate and reliable. However, STMicroelectronics assumes no responsibility for the consequences of use of such information nor for any infringement of patents or other rights of third parties which may result from its use. No license is granted by implication or otherwise under any patent or patent rights of STMicroelectronics. Specifications mentioned in this publication are subject to change without notice. This publication supersedes and replaces all information previously supplied. STMicroelectronics products are not authorized for use as critical components in life support devices or systems without express written approval of STMicroelectronics.

The ST logo is a registered trademark of STMicroelectronics.  
ECOPACK is a registered trademark of STMicroelectronics.  
All other names are the property of their respective owners

© 2005 STMicroelectronics - All rights reserved

STMicroelectronics group of companies  
Australia - Belgium - Brazil - Canada - China - Czech Republic - Finland - France - Germany - Hong Kong - India - Israel - Italy - Japan -  
Malaysia - Malta - Morocco - Singapore - Spain - Sweden - Switzerland - United Kingdom - United States of America  
[www.st.com](http://www.st.com)