



74VCXHQ163245

16-BIT DUAL SUPPLY BUS TRANSCEIVER LEVEL TRANSLATOR WITH BUS HOLD AND EMI NOISE CONTROL

- HIGH SPEED: $t_{PD} = 6.0ns$ (MAX.) at $T_A = 85^\circ C$
 $V_{CCA} = 3.0V$ $V_{CCB} = 2.3V$; Bn to An
- LOW POWER DISSIPATION:
 $I_{CCA} = I_{CCB} = 20\mu A$ (MAX.) at $T_A = 85^\circ C$
- SYMMETRICAL OUTPUT IMPEDANCE:
 $|I_{OHA}| = I_{OLA} = 2.6mA$ MIN at
 $V_{CCA} = 3.0V$; $V_{CCB} = 1.65V$ or $2.3V$
 $|I_{OHB}| = I_{OLB} = 6mA$ (MIN at
 $V_{CCA} = 2.3V$ or $3.0V$; $V_{CCB} = 1.65V$)
- BALANCED PROPAGATION DELAYS:
 $t_{PLH} \approx t_{PHL}$
- POWER DOWN PROTECTION ON INPUTS AND OUTPUTS
- SERIES RESISTOR ON A SIDE
- LIMITED EMI NOISE: $t_{rA} \approx t_{fA} \geq 4ns$ at
 $C_L = 10pF$
- OPERATING VOLTAGE RANGE:
 $V_{CCA}(OPR) = 2.3V$ to $3.6V$ (1.2V Data Retention)
 $V_{CCB}(OPR) = 1.65V$ to $3.6V$ (1.2V Data Retention)
- PIN AND FUNCTION COMPATIBLE WITH 74 SERIES 16245
- BUS HOLD PROVIDED ON DATA INPUT BOTH SIDE
- LATCH-UP PERFORMANCE EXCEEDS 500mA (JESD 17)
- ESD PERFORMANCE:
HBM > 2000V (MIL STD 883 method 3015);
MM > 200V

DESCRIPTION

The 74VCXHQ163245 is a dual supply low voltage CMOS 16-BIT BUS TRANSCEIVER fabricated with sub-micron silicon gate and five-layer metal wiring C²MOS technology. Designed for use as an interface between a 3.3V bus and a 2.5V or 1.8V bus in a mixed 3.3V/1.8V, 3.3V/2.5V and 2.5V/1.8V supply systems, it achieves high speed operation while maintaining the CMOS low power dissipation and limited rise and fall time (Low EMI).

This IC is intended for two-way asynchronous communication between data buses and the direction of data transmission is determined by nDIR inputs. The enable inputs nG can be used to disable the device so that the buses are effectively

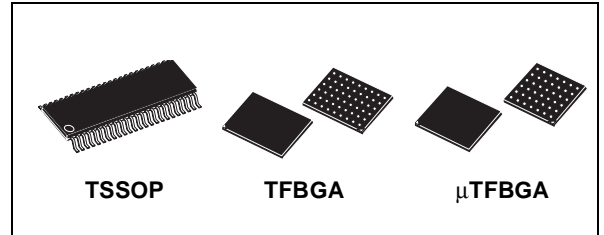

Table 1: Order Codes

| PACKAGE | T & R |
|--------------|------------------|
| TSSOP48 | 74VCXHQ163245TTR |
| TFBGA54 | 74VCXHQ163245LBR |
| μTFBGA42 | 74VCXHQ163245TBR |
| μTFBGA42 (*) | 74VCXHQ163245R-E |

(*) Lead-Free Compliant.

isolated. The A-port interfaces with the 3V bus, the B-port with the 2.5V and 1.8V bus. All inputs are equipped with protection circuits against static discharge, giving them 2KV ESD immunity and transient excess voltage. All floating bus terminals during High Z State don't need external pull-up or pull-down resistor.

Figure 1: Logic Diagram

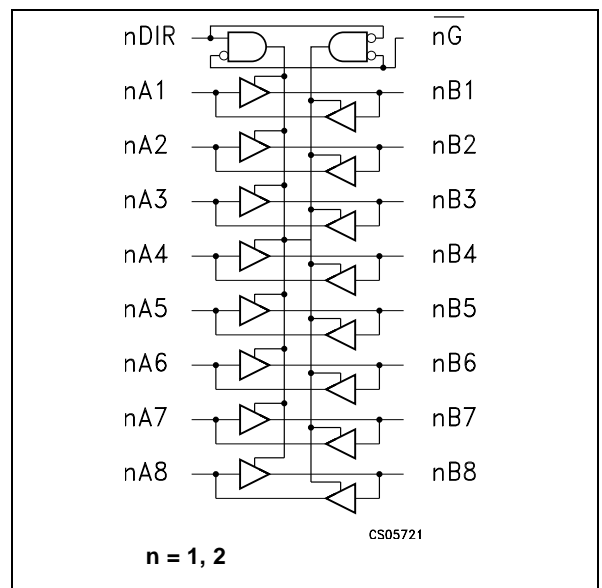

Figure 2: Input And Output Equivalent Circuit

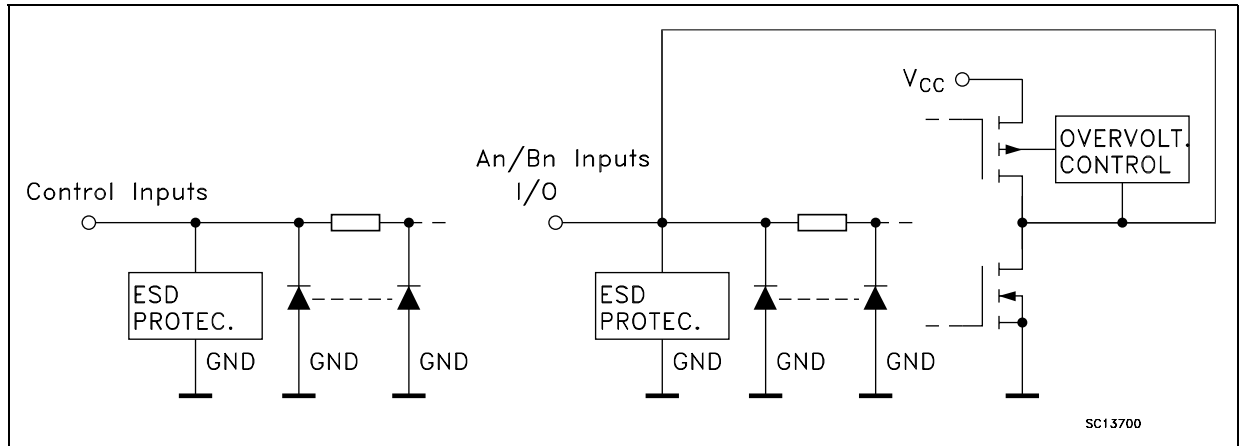

Table 2: Pin Description

| TFBGA54 PIN N° | μTFBGA42 PIN N° | TSSOP PIN N° | SYMBOL | NAME AND FUNCTION |
|-----------------------------------|-----------------------------------|-----------------------------------|------------------|-------------------------|
| A3 | B3 | 1 | 1DIR | Directional Controls |
| J3 | F3 | 24 | 2DIR | Directional Controls |
| A6, B5, B6, C5, C6, D5, D6, E5 | A4, A5, A6, B5, B6, C5, C6, D5 | 47, 46, 44, 43, 41, 40, 38, 37 | 1A1 to 1A8 | Data Inputs/Outputs |
| E6, F5, F6, G5, G6, H5, H6, J6 | D6, E5, E6, F5, F6, G4, G5, G6 | 36, 35, 33, 32, 30, 29, 27, 26 | 2A1 to 2A8 | Data Inputs/Outputs |
| A1, B2, B1, C2, C1, D2, D1, E2 | A3, A2, A1, B2, B1, C2, C1, D2 | 2, 3, 5, 6, 8, 9, 11, 12 | 1B1 to 1B8 | Data Inputs/Outputs |
| E1, F2, F1, G2, G1, H2, H1, J1 | D1, E2, E1, F2, F1, G3, G2, G1 | 13, 14, 16, 17, 19, 20, 22, 23 | 2B1 to 2B8 | Data Inputs/Outputs |
| J4 | F4 | 25 | 2G | Output Enable Inputs |
| A4 | B4 | 48 | 1G | Output Enable Inputs |
| D3, D4, E3, E4, F3, F4 | C3, C4, E3, E4 | 4, 10, 15, 21, 28, 34, 39, 45 | GND | Ground (0V) |
| A2, A5, B3, B4, H3, H4, J2, J5 | - | - | NC | No Connected |
| C4, G4 | D4 | 42, 31 | V _{CCA} | Positive Supply Voltage |
| C3, G3 | D3 | 7, 18 | V _{CCB} | Positive Supply Voltage |

Figure 3: Pin Connection (top view for TSSOP, top through view for BGA)

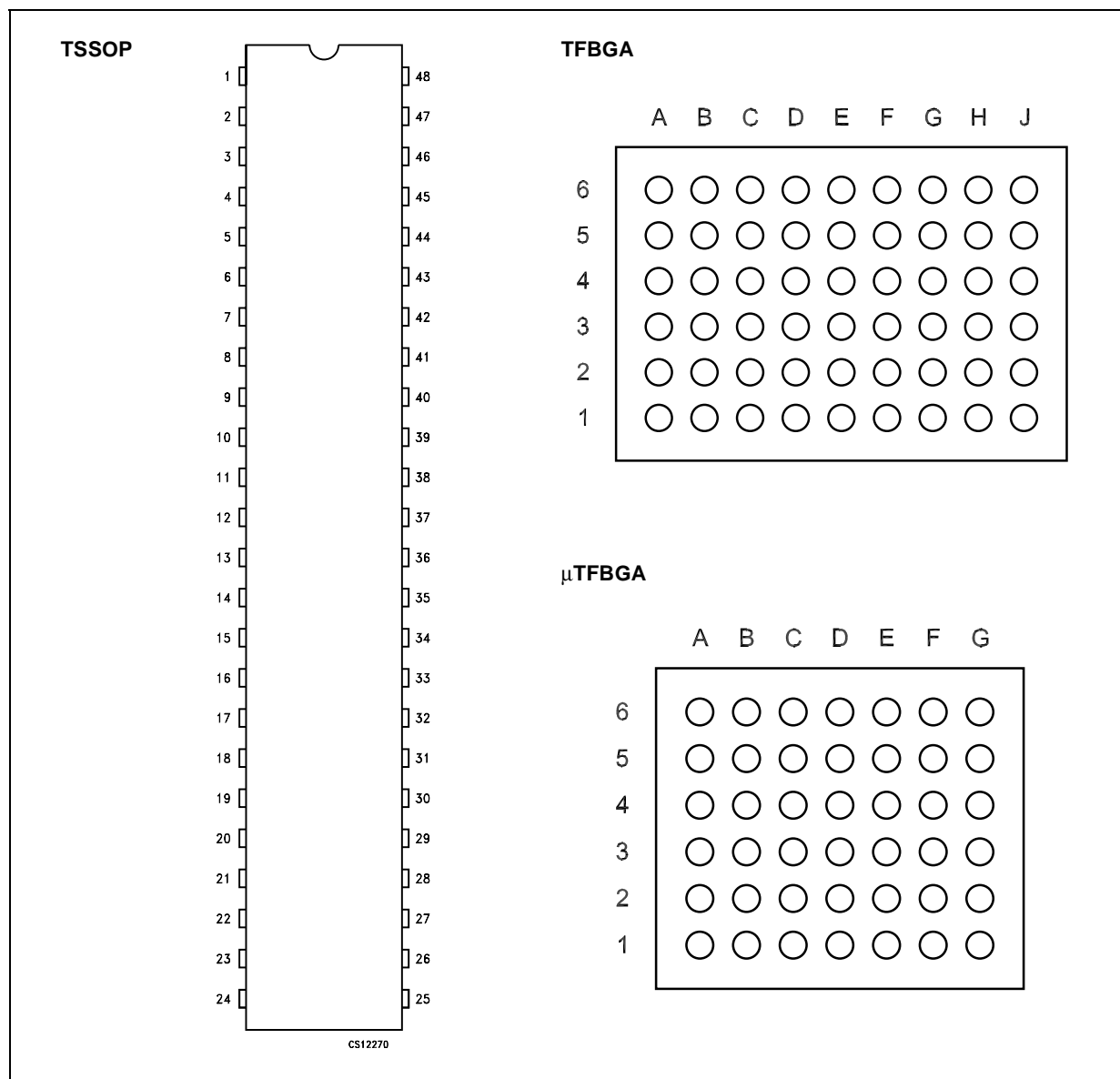

Table 3: Truth Table

| INPUTS | | FUNCTION | | OUTPUT |
|-----------------------|-----|----------|--------|--------|
| $\overline{\text{G}}$ | DIR | A BUS | B BUS | |
| L | L | OUTPUT | INPUT | A = B |
| L | H | INPUT | OUTPUT | B = A |
| H | X | Z | Z | Z |

X=Don't care; Z=High Impedance

Table 4: Absolute Maximum Ratings

| Symbol | Parameter | Value | Unit |
|------------|----------------------------------|-------------------------|------|
| V_{CCA} | Supply Voltage | -0.5 to +4.6 | V |
| V_{CCB} | Supply Voltage | -0.5 to $+V_{CCA}+0.5$ | V |
| V_I | DC Input Voltage | -0.5 to +4.6 | V |
| $V_{I/OA}$ | DC I/O Voltage (Output disabled) | -0.5 to +4.6 | V |
| $V_{I/OB}$ | DC I/O Voltage (Output disabled) | -0.5 to +4.6 | V |
| $V_{I/OA}$ | DC I/O Voltage | -0.5 to $V_{CCA} + 0.5$ | V |
| $V_{I/OB}$ | DC I/O Voltage | -0.5 to $V_{CCB} + 0.5$ | V |
| I_{IK} | DC Input Diode Current | - 20 | mA |
| I_{OK} | DC Output Diode Current | - 50 | mA |
| I_{OA} | DC Output Current | ± 50 | mA |
| I_{OB} | DC Output Current | ± 50 | mA |
| I_{CCA} | DC V_{CC} or Ground Current | ± 100 | mA |
| I_{CCB} | DC V_{CC} or Ground Current | ± 100 | mA |
| P_d | Power Dissipation | 400 | mW |
| T_{stg} | Storage Temperature | -65 to +150 | °C |
| T_L | Lead Temperature (10 sec) | 260 | °C |

Absolute Maximum Ratings are those value beyond which damage to the device may occur. Functional operation under these conditions is not implied

Table 5: Recommended Operating Conditions

| Symbol | Parameter | Value | Unit |
|------------|-----------------------------------|-------------------|------|
| V_{CCA} | Supply Voltage | 2.3 to 3.6 | V |
| V_{CCB} | Supply Voltage | 1.65 to V_{CCA} | V |
| V_I | Input Voltage (Dir, G) | 0 to V_{CCB} | V |
| $V_{I/OA}$ | I/O Voltage | 0 to V_{CCA} | V |
| $V_{I/OB}$ | I/O Voltage | 0 to V_{CCB} | V |
| T_{op} | Operating Temperature | -40 to 85 | °C |
| dt/dv | Input Rise and Fall Time (note 1) | 0 to 10 | ns/V |

1) V_{IN} from 0.8V to 2.0V at $V_{CC}=3.0V$

Table 6: DC Specification For V_{CCA}

| Symbol | Parameter | Test Condition | | | Value | | | | | Unit |
|-----------------------|---|-------------------------|-------------------------|--|----------------------------------|------|-----------|--|-----------|---------------|
| | | V_{CCB} (*) (V) | V_{CCA} (*) (V) | | $T_A = 25\text{ }^\circ\text{C}$ | | | $-40\text{ to }85\text{ }^\circ\text{C}$ | | |
| | | | | | Min. | Typ. | Max. | Min. | Max. | |
| V_{IHA} | High Level Input Voltage (An) | 1.8 | 2.5 | | 1.6 | | | 1.6 | | V |
| | | 1.8 | 3.3 | | 2.0 | | | 2.0 | | |
| | | 2.5 | 3.3 | | 2.0 | | | 2.0 | | |
| V_{ILA} | Low Level Input Voltage (An) | 1.8 | 2.5 | | | | 0.7 | | 0.7 | V |
| | | 1.8 | 3.3 | | | | 0.8 | | 0.8 | |
| | | 2.5 | 3.3 | | | | 0.8 | | 0.8 | |
| V_{OHA} | High Level Output Voltage | 2.3 | 3.0 | $I_O = -100\mu\text{A}$ | 2.8 | | | 2.8 | | V |
| | | 2.3 | 3.0 | $I_O = -2.6\text{mA}$ | 2.61 | | | 2.55 | | |
| | | 1.65 | 3.0 | $I_O = -2.6\text{mA}$ | 2.61 | | | 2.55 | | |
| | | 1.65 | 2.3 | $I_O = -2.1\text{mA}$ | 1.95 | | | 1.87 | | |
| V_{OLA} | Low Level Output Voltage | 2.3 | 3.0 | $I_O = 100\mu\text{A}$ | | | 0.2 | | 0.2 | V |
| | | 2.3 | 3.0 | $I_O = 2.6\text{mA}$ | | | 0.31 | | 0.33 | |
| | | 1.65 | 3.0 | $I_O = 2.6\text{mA}$ | | | 0.31 | | 0.33 | |
| | | 1.65 | 2.3 | $I_O = 2.1\text{mA}$ | | | 0.31 | | 0.33 | |
| I_{IA} | Input Leakage Current | 2.7 | 3.6 | $V_I = V_{CC}$ or GND | | | ± 0.5 | | ± 5 | μA |
| $I_{IA(\text{HOLD})}$ | Input Hold Current | 1.65 | 2.3 | $V_I = 0.7\text{ V}$ | 45 | | | 45 | | μA |
| | | 1.65 | 2.3 | $V_I = 1.6\text{ V}$ | -45 | | | -45 | | |
| | | 1.65 | 3.0 | $V_I = 0.8\text{ V}$ | 75 | | | 75 | | |
| | | 1.65 | 3.0 | $V_I = 2.0\text{ V}$ | -75 | | | -75 | | |
| | | 2.3 | 3.0 | $V_I = 0.8\text{ V}$ | 75 | | | 75 | | |
| | | 2.3 | 3.0 | $V_I = 2.0\text{ V}$ | -75 | | | -75 | | |
| | | 2.7 | 3.6 | $V_I = 0\text{ to }3.6\text{ V}$ | | | | | ± 500 | |
| I_{OZA} | High Impedance Output Leakage Current | 2.7 | 3.6 | $V_{IA} = \text{GND or } 3.6\text{V}$ $V_{IB} = V_{IHB} \text{ or } V_{ILB}$ $\bar{G} = V_{CCB}$ | | | ± 1.0 | | ± 10 | μA |
| I_{OFF} | Power Off Leakage Current | 0 | 0 | $V_{IA} = \text{GND to } 3.6\text{V}$ $V_{IB} = \text{GND to } 3.6\text{V}$ $\bar{G}, \text{Dir} = \text{GND to } 3.6\text{V}$ | | | ± 1.0 | | ± 10 | μA |
| I_{CCtA} | Quiescent Supply Current | 1.95 | 3.6 | $V_{IA} = V_{CCA}$ or GND | | | 2 | | 20 | μA |
| | | 1.95 | 2.7 | $V_{IB} = V_{CCB}$ or GND | | | | | | |
| | | 2.7 | 3.6 | Dir or $\bar{G} = V_{CCB}$ or GND | | | | | | |
| ΔI_{CCtA} | Maximum Quiescent Supply Current / Input (An) | 2.7 | 3.6 | | | | | | 0.75 | mA |
| | | 1.95 | 3.6 | $V_{IA} = V_{CCA} - 0.6\text{V}$ | | | | | | |
| | | 1.95 | 2.7 | $V_{IB} = V_{CCB}$ or GND | | | | | | |

(*) V_{CC} range = 3.3 ± 0.3 ; $2.5\pm 0.2\text{V}$; $1.8\pm 0.15\text{V}$

Table 7: DC Specification For V_{CCB}

| Symbol | Parameter | Test Condition | | | Value | | | | | Unit |
|-----------------------|--|-------------------------|-------------------------|--|----------------------------------|------|---------------|--|---------------|---------------|
| | | V_{CCB} (V) (*) | V_{CCA} (V) (*) | | $T_A = 25\text{ }^\circ\text{C}$ | | | $-40\text{ to }85\text{ }^\circ\text{C}$ | | |
| | | | | | Min. | Typ. | Max. | Min. | Max. | |
| V_{IHB} | High Level Input Voltage (Bn, Dir, \bar{G}) | 1.8 | 2.5 | | $0.65V_{CCB}$ | | | $0.65V_{CCB}$ | | V |
| | | 1.8 | 3.3 | | $0.65V_{CCB}$ | | | $0.65V_{CCB}$ | | |
| | | 2.5 | 3.3 | | 1.6 | | | 1.6 | | |
| V_{ILB} | Low Level Input Voltage (Bn, Dir, \bar{G}) | 1.8 | 2.5 | | | | $0.35V_{CCB}$ | | $0.35V_{CCB}$ | V |
| | | 1.8 | 3.3 | | | | $0.35V_{CCB}$ | | $0.35V_{CCB}$ | |
| | | 2.5 | 3.3 | | | | 0.7 | | 0.7 | |
| V_{OHB} | High Level Output Voltage | 2.3 | 3.0 | $I_O = -100\mu\text{A}$ | 2.1 | | | 2.1 | | V |
| | | 2.3 | 3.0 | $I_O = -18\text{mA}$ | 1.7 | | | 1.7 | | |
| | | 1.65 | 3.0 | $I_O = -6\text{mA}$ | 1.25 | | | 1.25 | | |
| | | 1.65 | 2.3 | $I_O = -6\text{mA}$ | 1.25 | | | 1.25 | | |
| V_{OLB} | Low Level Output Voltage | 2.3 | 3.0 | $I_O = 100\mu\text{A}$ | | | 0.2 | | 0.2 | V |
| | | 2.3 | 3.0 | $I_O = 18\text{mA}$ | | | 0.60 | | 0.60 | |
| | | 1.65 | 3.0 | $I_O = 6\text{mA}$ | | | 0.30 | | 0.30 | |
| | | 1.65 | 2.3 | $I_O = 6\text{mA}$ | | | 0.30 | | 0.30 | |
| I_{IB} | Input Leakage Current | 2.7 | 3.6 | $V_I = V_{CC}$ or GND | | | ± 0.5 | | ± 5 | μA |
| $I_{IB(\text{HOLD})}$ | Input Hold Current | 1.65 | 2.3 | $V_I = 0.57\text{ V}$ | 25 | | | 25 | | μA |
| | | 1.65 | 2.3 | $V_I = 1.07\text{ V}$ | -25 | | | -25 | | |
| | | 1.65 | 3.0 | $V_I = 0.57\text{ V}$ | 25 | | | 25 | | |
| | | 1.65 | 3.0 | $V_I = 1.07\text{ V}$ | -25 | | | -25 | | |
| | | 2.3 | 3.0 | $V_I = 0.7\text{ V}$ | 45 | | | 45 | | |
| | | 2.3 | 3.0 | $V_I = 1.6\text{ V}$ | -45 | | | -45 | | |
| | | 2.7 | 3.6 | $V_I = 0\text{ to }2.7\text{ V}$ | | | | | ± 500 | |
| I_{OZB} | High Impedance Output Leakage Current | 2.7 | 3.6 | $V_{IA} = V_{IHA}$ or V_{ILA} $V_{IB} = \text{GND}$ or 3.6V $\bar{G} = V_{CCB}$ | | | ± 1.0 | | ± 10 | μA |
| I_{CCtB} | Quiescent Supply Current | 1.95 | 3.6 | $V_{IA} = V_{CCA}$ or GND | | | 2 | | 20 | μA |
| | | 1.95 | 2.7 | $V_{IB} = V_{CCB}$ or GND | | | | | | |
| | | 2.7 | 3.6 | Dir or $\bar{G} = V_{CCB}$ or GND | | | | | | |
| ΔI_{CCtB} | Maximum Quiescent Supply Current / Input (Bn, DIR, \bar{G}) | 2.7 | 3.6 | | | | | | 0.75 | mA |
| | | 1.95 | 3.6 | $V_{IB} = V_{CCB} - 0.6\text{V}$ | | | | | | |
| | | 1.95 | 2.7 | $V_{IA} = V_{CCA}$ or GND | | | | | | |

(*) V_{CC} range = 3.3 ± 0.3 ; $2.5\pm 0.2\text{V}$; $1.8\pm 0.15\text{V}$

Table 8: Dynamic Switching Characteristics

| Symbol | Parameter | Test Condition | | | Value | | | | | Unit |
|-------------------|------------------------------------|------------------------------------|------------------------------------|---|------------------------|-------|------|--------------|------|------|
| | | V _{C_{CB}} (V) | V _{C_{CA}} (V) | | T _A = 25 °C | | | -40 to 85 °C | | |
| | | | | | Min. | Typ. | Max. | Min. | Max. | |
| V _{OLPA} | Dynamic Low Level Quiet An Output | 1.8 | 2.5 | C _L = 10pF V _{IL} = 0V V _{IH} = V _{C_{CB}} | | 0.15 | | | | V |
| | | 1.8 | 3.3 | | | 0.20 | | | | |
| | | 2.5 | 3.3 | | | 0.20 | | | | |
| V _{OLPB} | Dynamic Low Level Quiet Bn Output | 1.8 | 2.5 | C _L = 30pF V _{IL} = 0V V _{IH} = V _{C_{CA}} | | 0.25 | | | V | |
| | | 1.8 | 3.3 | | | 0.25 | | | | |
| | | 2.5 | 3.3 | | | 0.60 | | | | |
| V _{OLVA} | Dynamic Low Level Quiet An Output | 1.8 | 2.5 | C _L = 10pF V _{IL} = 0V V _{IH} = V _{C_{CB}} | | -0.15 | | | V | |
| | | 1.8 | 3.3 | | | -0.20 | | | | |
| | | 2.5 | 3.3 | | | -0.20 | | | | |
| V _{OLVB} | Dynamic Low Level Quiet Bn Output | 1.8 | 2.5 | C _L = 30pF V _{IL} = 0V V _{IH} = V _{C_{CA}} | | -0.25 | | | V | |
| | | 1.8 | 3.3 | | | -0.25 | | | | |
| | | 2.5 | 3.3 | | | -0.60 | | | | |
| V _{OHVA} | Dynamic High Level Quiet An Output | 1.8 | 2.5 | C _L = 10pF V _{IL} = 0V V _{IH} = V _{C_{CB}} | | 2.35 | | | V | |
| | | 1.8 | 3.3 | | | 3.10 | | | | |
| | | 2.5 | 3.3 | | | 3.10 | | | | |
| V _{OHVB} | Dynamic High Level Quiet Bn Output | 1.8 | 2.5 | C _L = 30pF V _{IL} = 0V V _{IH} = V _{C_{CA}} | | 1.70 | | | V | |
| | | 1.8 | 3.3 | | | 1.70 | | | | |
| | | 2.5 | 3.3 | | | 2.00 | | | | |

Table 9: AC Electrical Characteristics (C_{LA} = 10pF, C_{LB} = 30pF, R_L = 500Ω)

| Symbol | Parameter | Test Condition T _A = -40 to 85 °C | | | | | | Unit |
|--|---------------------------------------|--|------|---|------|--|------|------|
| | | V _{C_{CB}} = 1.8 ± 0.15V | | V _{C_{CB}} = 1.8 ± 0.15V | | V _{C_{CB}} = 2.5 ± 0.2V | | |
| | | V _{C_{CA}} = 2.5 ± 0.2V | | V _{C_{CA}} = 3.3 ± 0.3V | | V _{C_{CA}} = 3.3 ± 0.3V | | |
| | | Min. | Max. | Min. | Max. | Min. | Max. | |
| t _{PLH} t _{PHL} | Propagation Delay Time An to Bn | 1.0 | 5.5 | 1.0 | 5.0 | 1.0 | 4.4 | ns |
| t _{PLH} t _{PHL} | Propagation Delay Time Bn to An | 1.0 | 7.7 | 1.0 | 6.5 | 1.0 | 6.0 | |
| t _{PZL} t _{PZH} | Output Enable Time G to An | 1.0 | 8.5 | 1.0 | 7.1 | 1.0 | 6.5 | ns |
| t _{PZL} t _{PZH} | Output Enable Time G to Bn | 1.0 | 7.0 | 1.0 | 7.0 | 1.0 | 5.0 | |
| t _{PLZ} t _{PHZ} | Output Disable Time G to An | 1.0 | 5.0 | 1.0 | 5.0 | 1.0 | 4.5 | ns |
| t _{PLZ} t _{PHZ} | Output Disable Time G to Bn | 1.0 | 5.0 | 1.0 | 5.0 | 1.0 | 4.5 | |
| t _{OSLH} t _{OSHL} | Output To Output Skew Time (note1, 2) | | 0.5 | | 0.5 | | 0.75 | ns |

1) Skew is defined as the absolute value of the difference between the actual propagation delay for any two outputs of the same device switching in the same direction, either HIGH or LOW (t_{OSLH} = | t_{PLHm} - t_{PLHn} |, t_{OSHL} = | t_{PHLm} - t_{PHLn} |)

2) Parameter guaranteed by design

Table 10: Capacitance Characteristics

| Symbol | Parameter | Test Condition | | | Value | | | | | Unit |
|-----------|-------------------------------|------------------|------------------|---------|----------------------------------|------|------|--|------|------|
| | | V_{CCA} (V) | V_{CCB} (V) | | $T_A = 25\text{ }^\circ\text{C}$ | | | $-40\text{ to }85\text{ }^\circ\text{C}$ | | |
| | | | | | Min. | Typ. | Max. | Min. | Max. | |
| C_{INB} | Input Capacitance | open | open | | | 5 | | | | pF |
| $C_{I/O}$ | Input/Output Capacitance | 3.3 | 2.5 | | | 6 | | | | pF |
| C_{PD} | Power Dissipation Capacitance | 3.3 | 2.5 | f=10MHz | | 29 | | | | pF |
| | | 3.3 | 1.8 | | | 29 | | | | |

1) C_{PD} is defined as the value of the IC's internal equivalent capacitance which is calculated from the operating current consumption without load. (Refer to Test Circuit). Average current can be obtained by the following equation. $I_{CC(opr)} = C_{PD} \times V_{CC} \times f_{IN} + I_{CC}/16$ (per circuit)

Figure 4: Test Circuit

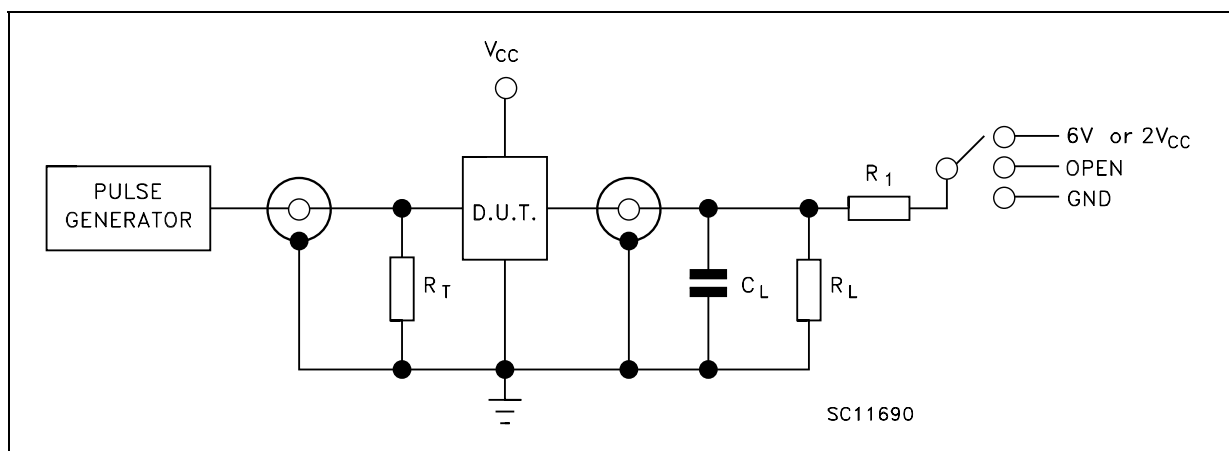

| TEST | SWITCH |
|--|-----------|
| t_{PLH} , t_{PHL} | Open |
| t_{PZL} , t_{PLZ} ($V_{CC} = 3.0$ to $3.6V$) | 6V |
| t_{PZL} , t_{PLZ} ($V_{CC} = 2.3$ to $2.7V$ or $V_{CC} = 1.65$ to $1.95V$) | $2V_{CC}$ |
| t_{PZH} , t_{PHZ} | GND |

$C_L = 10/30\text{pF}$ or equivalent (includes jig and probe capacitance)

$R_L = R_1 = 500\Omega$ or equivalent

$R_T = Z_{OUT}$ of pulse generator (typically 50Ω)

Table 11: Waveform Symbol Value

| Symbol | V_{CC} | | |
|----------|-----------------|------------------|------------------|
| | 3.0 to 3.6V | 2.3 to 2.7V | 1.65 to 1.95V |
| V_{IH} | V_{CC} | V_{CC} | V_{CC} |
| V_M | 1.5V | $V_{CC}/2$ | $V_{CC}/2$ |
| V_X | $V_{OL} + 0.3V$ | $V_{OL} + 0.15V$ | $V_{OL} + 0.15V$ |
| V_Y | $V_{OL} - 0.3V$ | $V_{OL} - 0.15V$ | $V_{OL} - 0.15V$ |

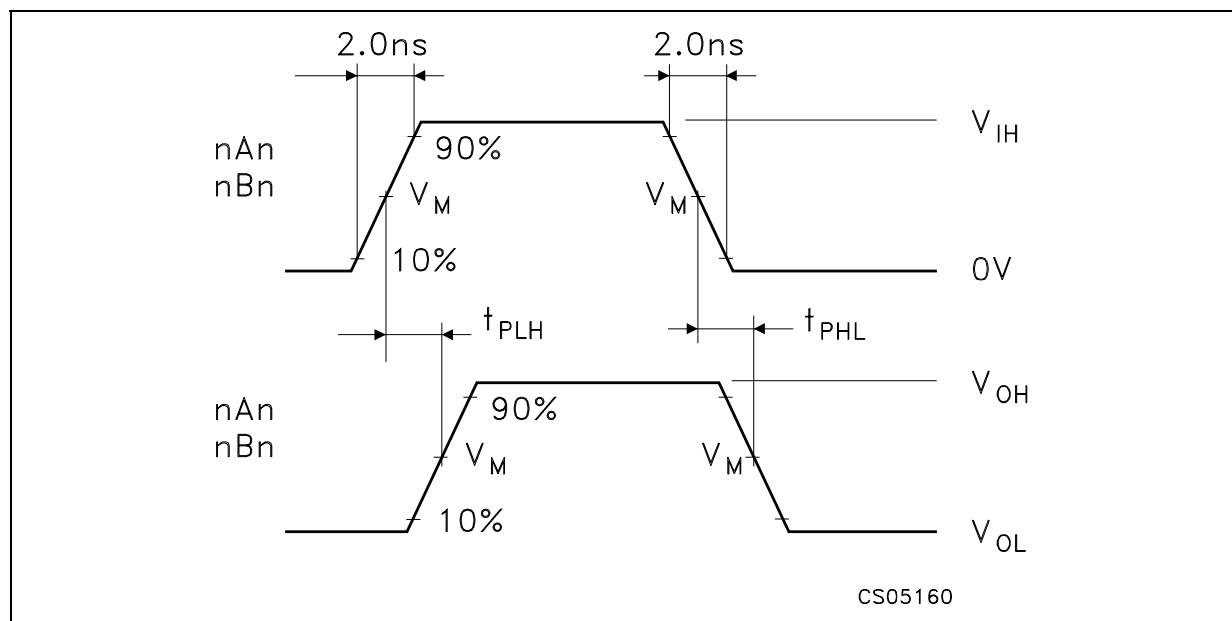
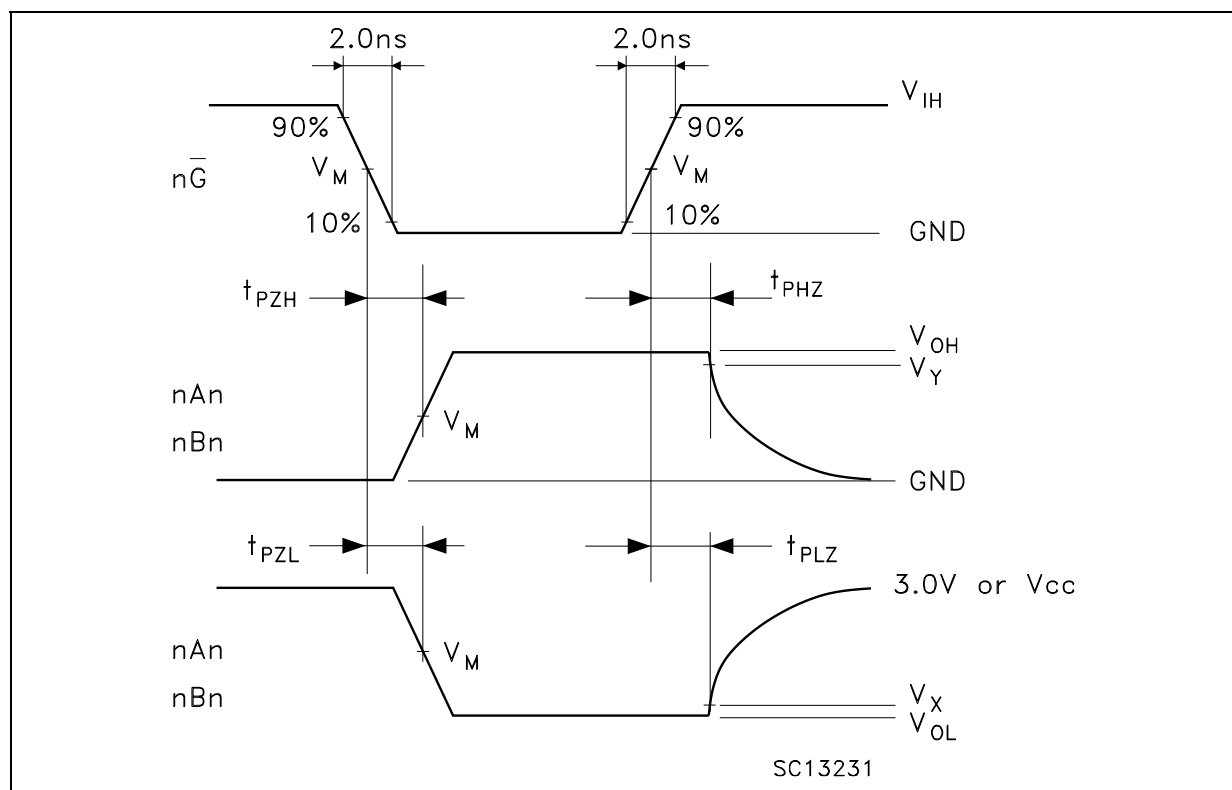
Figure 5: Waveform - Propagation Delay ($f=1\text{MHz}$; 50% duty cycle)Figure 6: Waveform - Output Enable And Disable Time ($f=1\text{MHz}$; 50% duty cycle)

TSSOP48 MECHANICAL DATA

| DIM. | mm. | | | inch | | |
|------|------|---------|------|--------|------------|--------|
| | MIN. | TYP. | MAX. | MIN. | TYP. | MAX. |
| A | | | 1.2 | | | 0.047 |
| A1 | 0.05 | | 0.15 | 0.002 | | 0.006 |
| A2 | | 0.9 | | | 0.035 | |
| b | 0.17 | | 0.27 | 0.0067 | | 0.011 |
| c | 0.09 | | 0.20 | 0.0035 | | 0.0079 |
| D | 12.4 | | 12.6 | 0.488 | | 0.496 |
| E | | 8.1 BSC | | | 0.318 BSC | |
| E1 | 6.0 | | 6.2 | 0.236 | | 0.244 |
| e | | 0.5 BSC | | | 0.0197 BSC | |
| K | 0° | | 8° | 0° | | 8° |
| L | 0.45 | | 0.75 | 0.018 | | 0.030 |

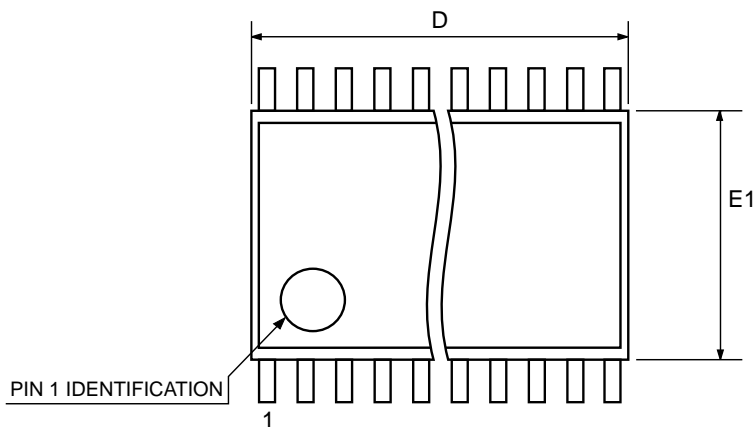
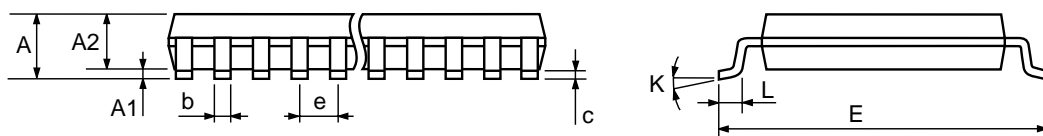

7065588D

TFBGA54 MECHANICAL DATA

| DIM. | mm. | | | mils | | |
|------|------|------|------|-------|-------|-------|
| | MIN. | TYP. | MAX. | MIN. | TYP. | MAX. |
| A | | | 1.2 | | | 47.2 |
| A1 | 0.25 | | | 9.8 | | |
| A2 | 0.78 | | 0.86 | 30.7 | | 33.8 |
| B | 0.35 | 0.4 | 0.45 | 13.7 | 15.7 | 17.7 |
| D | 7.9 | | 8.1 | 311.0 | | 318.9 |
| D1 | | 6.4 | | | 252.0 | |
| E | 5.4 | 5.5 | 5.6 | 212.6 | 216.5 | 220.5 |
| E1 | | 4 | | | 157.5 | |
| e | | 0.8 | | | 31.5 | |
| SE | | 0.4 | | | 15.7 | |

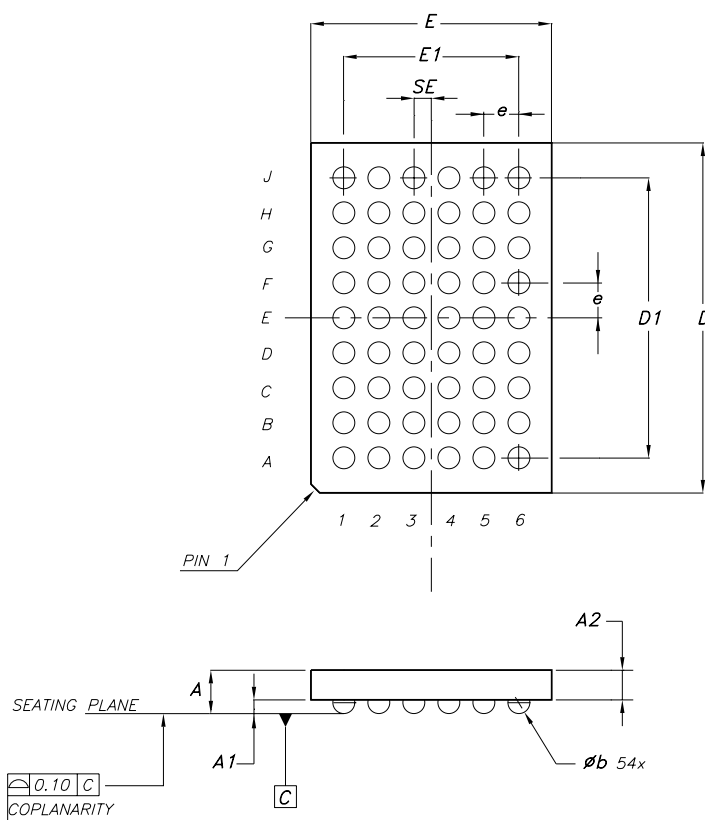

μTFBGA42 MECHANICAL DATA

| DIM. | mm. | | | mils | | |
|------|------|------|------|-------|-------|-------|
| | MIN. | TYP. | MAX. | MIN. | TYP. | MAX. |
| A | 1.0 | 1.1 | 1.16 | 39.4 | 43.3 | 45.7 |
| A1 | | | 0.25 | | | 9.8 |
| A2 | 0.78 | | 0.86 | 30.7 | | 33.9 |
| b | 0.25 | 0.30 | 0.35 | 9.8 | 11.8 | 13.8 |
| D | 3.9 | 4.0 | 4.1 | 153.5 | 157.5 | 161.4 |
| D1 | | 3 | | | 118.1 | |
| E | 3.4 | 3.5 | 3.6 | 133.9 | 137.8 | 141.7 |
| E1 | | 2.5 | | | 98.4 | |
| e | | 0.5 | | | 19.7 | |
| SE | | 0.25 | | | 9.8 | |

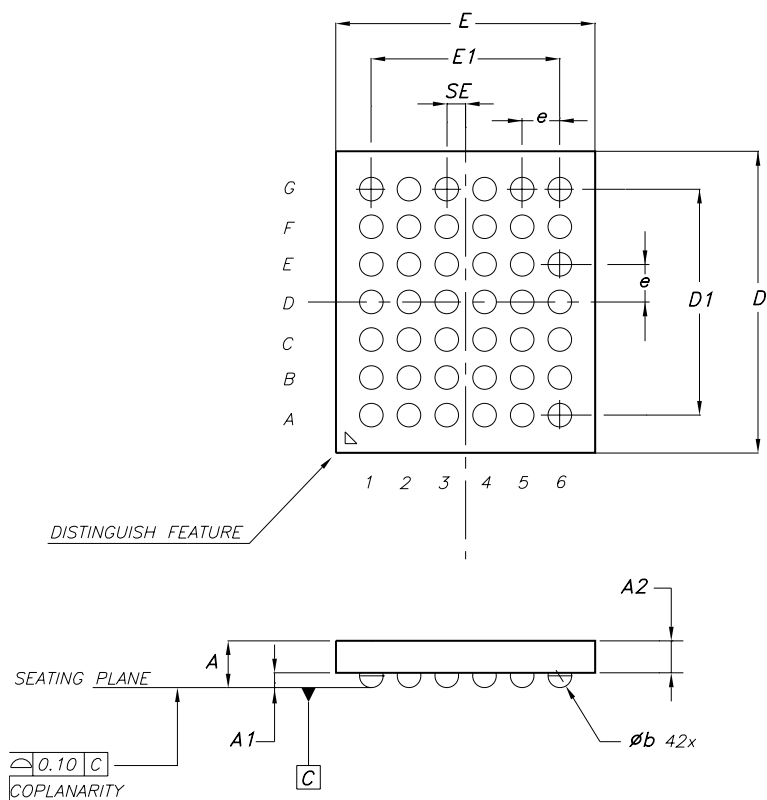

7513237/A

Tape & Reel TSSOP48 MECHANICAL DATA

| DIM. | mm. | | | inch | | |
|------|------|-----|------|-------|------|--------|
| | MIN. | TYP | MAX. | MIN. | TYP. | MAX. |
| A | | | 330 | | | 12.992 |
| C | 12.8 | | 13.2 | 0.504 | | 0.519 |
| D | 20.2 | | | 0.795 | | |
| N | 60 | | | 2.362 | | |
| T | | | 30.4 | | | 1.197 |
| Ao | 8.7 | | 8.9 | 0.343 | | 0.350 |
| Bo | 13.1 | | 13.3 | 0.516 | | 0.524 |
| Ko | 1.5 | | 1.7 | 0.059 | | 0.067 |
| Po | 3.9 | | 4.1 | 0.153 | | 0.161 |
| P | 11.9 | | 12.1 | 0.468 | | 0.476 |

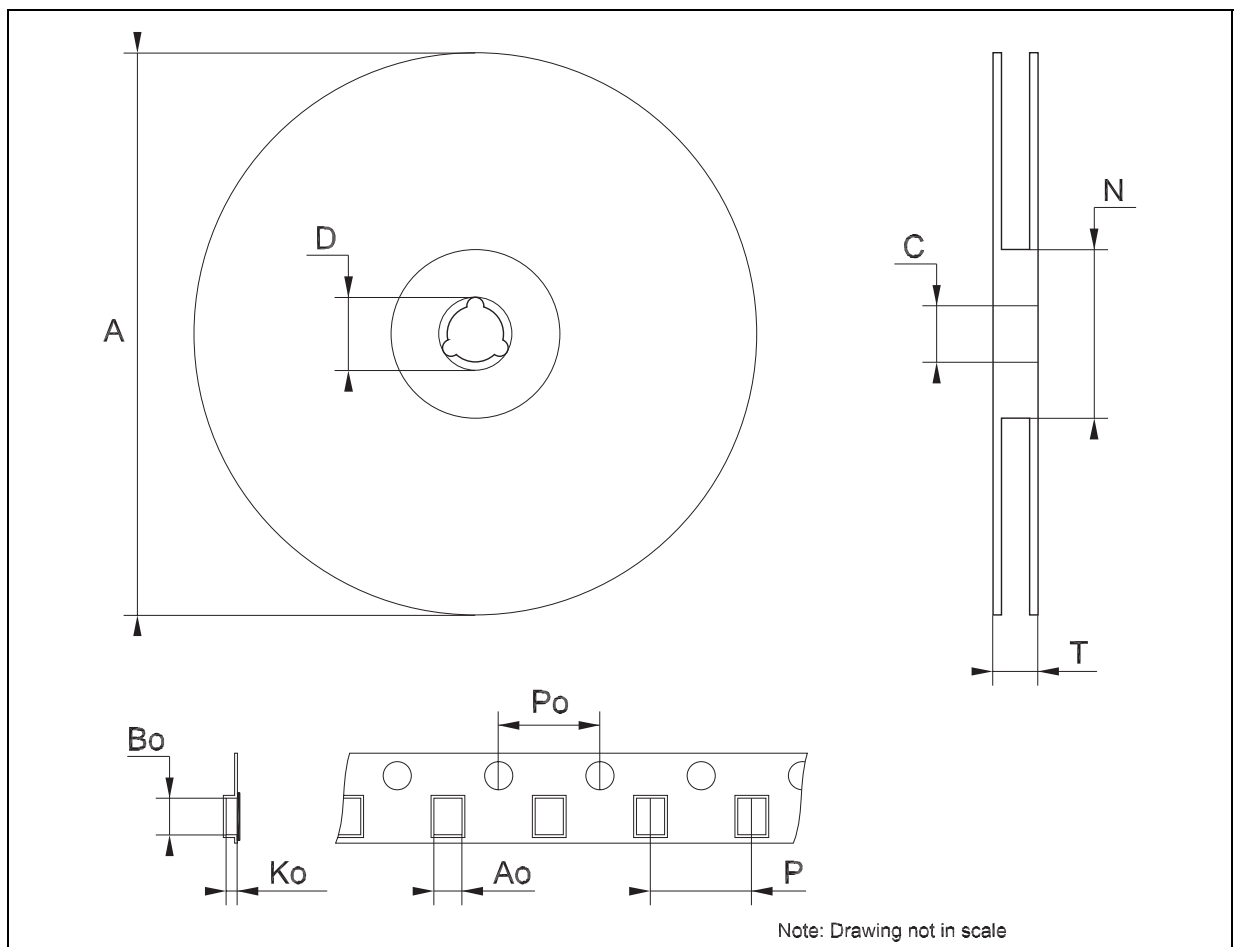

Tape & Reel TFBGA42 MECHANICAL DATA

| DIM. | mm. | | | inch | | |
|------|------|------|------|-------|-------|--------|
| | MIN. | TYP | MAX. | MIN. | TYP. | MAX. |
| A | | | 330 | | | 12.992 |
| C | 12.8 | | 13.2 | 0.504 | | 0.519 |
| D | 20.2 | | | 0.795 | | |
| N | 60 | | | 2.362 | | |
| T | | | 14.4 | | | 0.567 |
| Ao | | 3.8 | | | 0.149 | |
| Bo | | 4.3 | | | 0.169 | |
| Ko | | 1.05 | | | 0.041 | |
| Po | 3.9 | | 4.1 | 0.153 | | 0.161 |
| P | 7.9 | | 8.1 | 0.311 | | 0.319 |

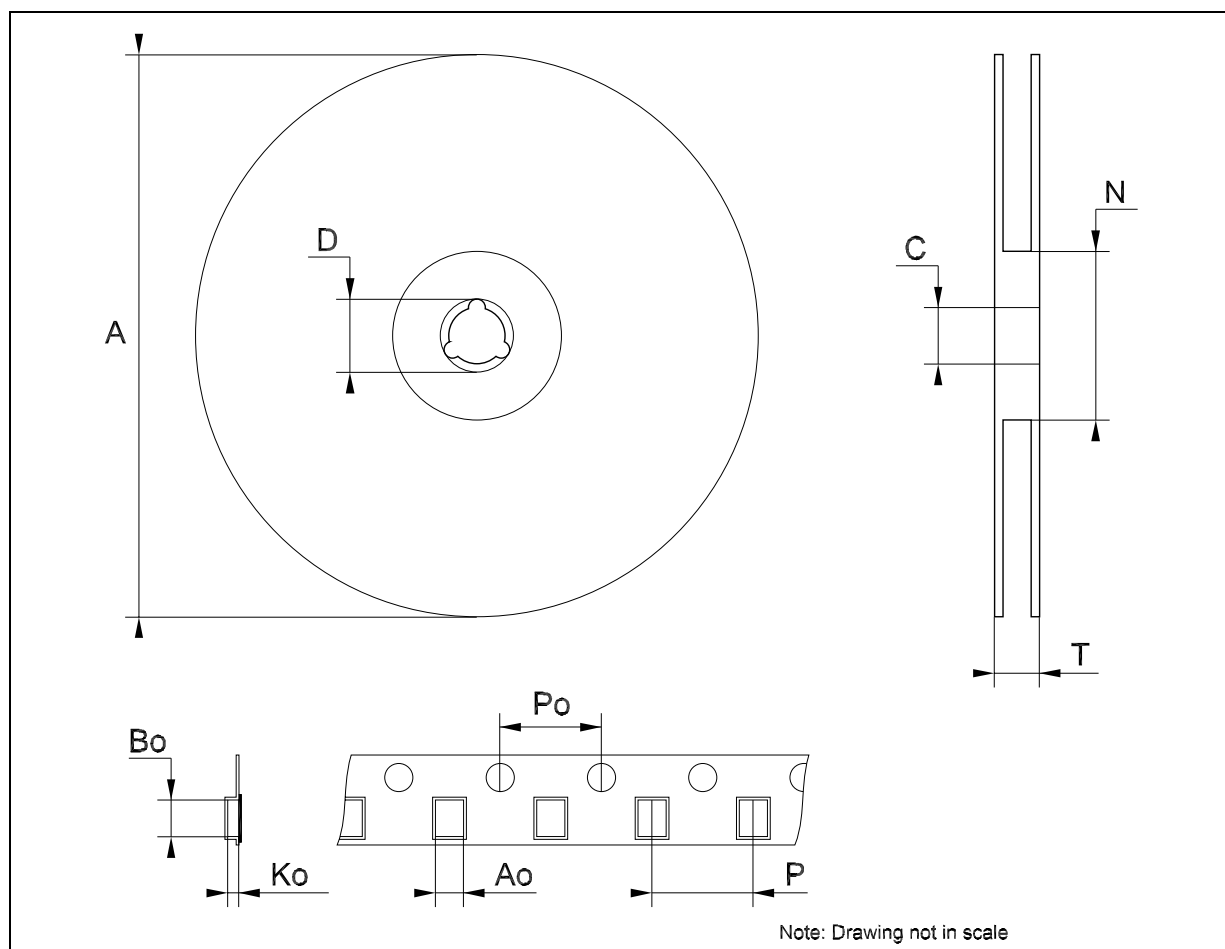

Tape & Reel TFBGA54 MECHANICAL DATA

| DIM. | mm. | | | inch | | |
|------|------|-----|------|-------|-------|--------|
| | MIN. | TYP | MAX. | MIN. | TYP. | MAX. |
| A | | | 330 | | | 12.992 |
| C | 12.8 | | 13.2 | 0.504 | | 0.519 |
| D | 20.2 | | | 0.795 | | |
| N | 60 | | | 2.362 | | |
| T | | | 22.4 | | | 0.882 |
| Ao | | 6.1 | | | 0.240 | |
| Bo | | 8.6 | | | 0.339 | |
| Ko | | 1.8 | | | 0.071 | |
| Po | 3.9 | | 4.1 | 0.153 | | 0.161 |
| P | 7.9 | | 8.1 | 0.311 | | 0.319 |

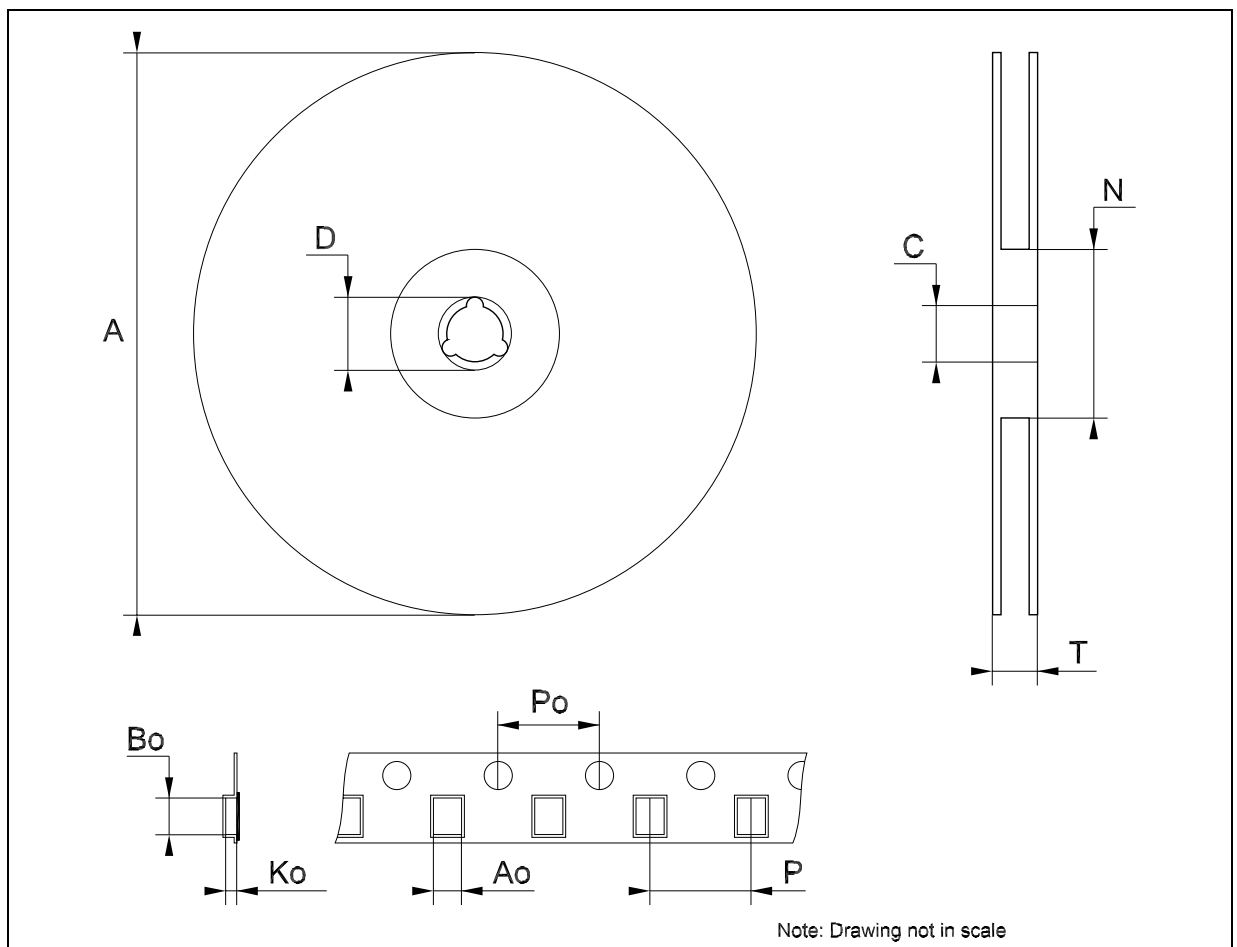

Table 12: Revision History

| Date | Revision | Description of Changes |
|-------------|-----------------|-------------------------------|
| 01-Sep-2004 | 1 | First Release. |
| 21-Dec-2004 | 2 | Add New Part Number. |
| 24-Jan-2005 | 3 | Add Note on Table 1. |

Information furnished is believed to be accurate and reliable. However, STMicroelectronics assumes no responsibility for the consequences of use of such information nor for any infringement of patents or other rights of third parties which may result from its use. No license is granted by implication or otherwise under any patent or patent rights of STMicroelectronics. Specifications mentioned in this publication are subject to change without notice. This publication supersedes and replaces all information previously supplied. STMicroelectronics products are not authorized for use as critical components in life support devices or systems without express written approval of STMicroelectronics.

The ST logo is a registered trademark of STMicroelectronics

All other names are the property of their respective owners

© 2005 STMicroelectronics - All Rights Reserved

STMicroelectronics group of companies

Australia - Belgium - Brazil - Canada - China - Czech Republic - Finland - France - Germany - Hong Kong - India - Israel - Italy - Japan - Malaysia - Malta - Morocco - Singapore - Spain - Sweden - Switzerland - United Kingdom - United States of America

www.st.com