

PCM REMOTE CONTROL TRANSMITTER

ADVANCED DATA

- 30 CHANNELS/4 ADDRESSES
- SELECTABLE FLASH/CARRIER TRANSMISSION MODE
- END OF TRANSMISSION CODE
- VERY LOW POWER DISSIPATION DURING TRANSMISSION : DUTY CYCLE 0.15 % (flash mode), 0.7 % (carrier mode)
- SINGLE CONTACT MATRIX KEYBOARD
- INTEGRATED ANTIBOUNCE AND INTER-LOCK
- WIDE SUPPLY RANGE (M708 4.5 to 10.5 V)/(M708A 3 to 10.5 V)
- WIDE REFERENCE FREQUENCY RANGE (445 to 510 kHz ceramic resonator)
- 20 PIN PLASTIC PACKAGE
- TO BE USED IN CONJUNCTION WITH M490/M491 SINGLE CHIP STATION MEMORY AND R.C. RECEIVER (flash mode) OR WITH MICROPROCESSOR CONTROLLED SYSTEM (carrier mode)

When the M708 works in conjunction with M490/M491 single chip Station Memory and R.C. receiver the oscillator frequency can be in the range 445 to 510 kHz and no synchronization is required with the receiver clock.

The M708 is produced with CMOS Si-gate technology and is available in a 20 pin dual in-line plastic package.

DESCRIPTION

This IC has been developed for remote control in consumer applications. It uses a highly reliable transmission code which has the capacity of 1024 channels. Each transmitted word is structured into 4 bits which constitute the address and 6 bits which constitute the command. However only 2 addresses and 30 commands are available in this IC. An additional command (000000) is used to transmit the "end of transmission code" when the key is released.

Additional bits are transmitted for synchronization of transmitter and receiver clocks and for security checks. The address organization provides simultaneous applications without interference among each system.

The receiver accepts the decoded command only if the transmitted address matches the address selected at the receiver. Four addresses are available for this purpose. The reference oscillator is controlled by a cheap ceramic resonator.

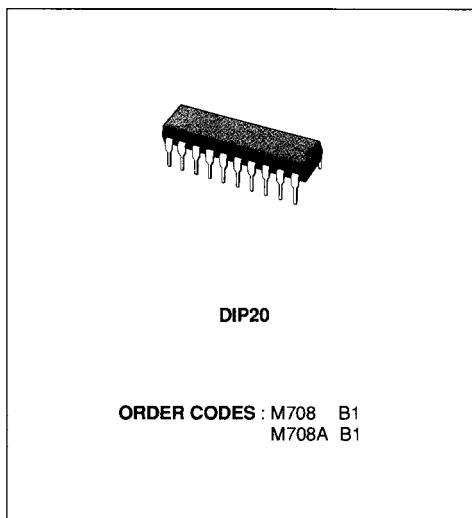

PIN CONNECTIONS

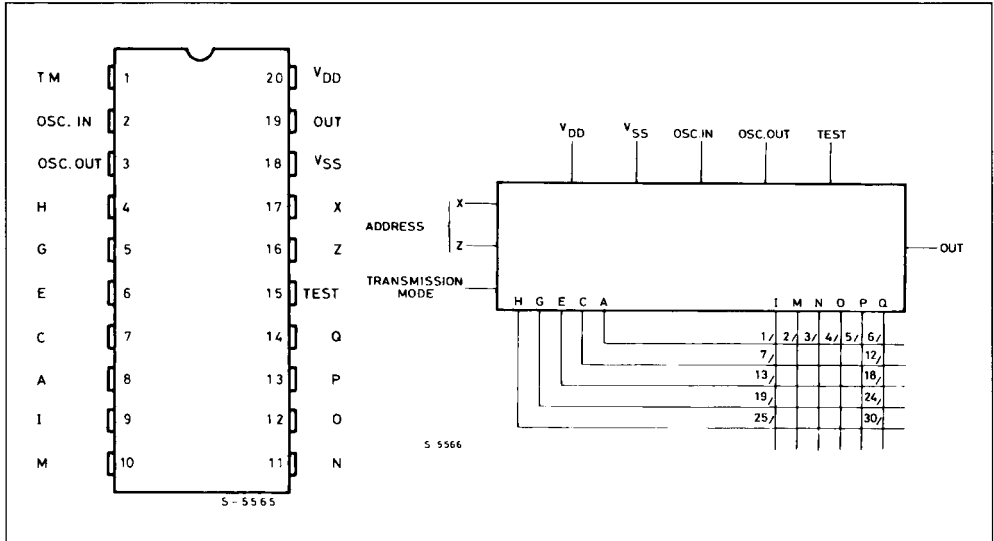

Note : The test pin must be connected to V_{SS} .

ABSOLUTE MAXIMUM RATINGS

Symbol	Parameter	Value	Unit
V_{DD}	Supply Voltage	- 0.3 to 12	V
V_I	Input Voltage	- 0.3 to $V_{DD} + 0.3$	V
$ I_O $	IR Output Current ($t < 50 \mu s$)	10	mA
T_{op}	Operating Temperature	0 to 70	$^{\circ}C$
P_{tot}	Total Package Power Dissipation	200	mW
T_{stg}	Storage Temperature	- 55 to 125	$^{\circ}C$

Stresses above those listed under "Absolute Maximum Ratings" may cause permanent damage to the device. This is a stress rating only and functional operation of the device at these or any other conditions above those indicated in the operational sections of this specification is not implied. Exposure to absolute maximum rating conditions for extended periods may affect device reliability.

RECOMMENDED OPERATING CONDITIONS

Symbol	Parameter	Value	Unit
V_{DD}	Supply Voltage : M708 M708A	4.5 to 10.5 3 to 10.5	V V
V_I	Input Voltage	0 to V_{DD}	V
$ I_O $	IR Output Current ($t < 50 \mu s$)	max. 2.5	mA
f_{ref}	Reference Frequency	445 to 510	kHz
T_{op}	Operating Temperature	0 to 70	$^{\circ}C$
r_s	Serial Resistance of a Closed Key Contact	max. 2.5	K Ω
r_p	Parallel Resistance of Open Key Contact	min. 2.2	M Ω
R_s	Serial Resistance of the Ceramic Resonator	max. 20	Ω

BLOCK DIAGRAM

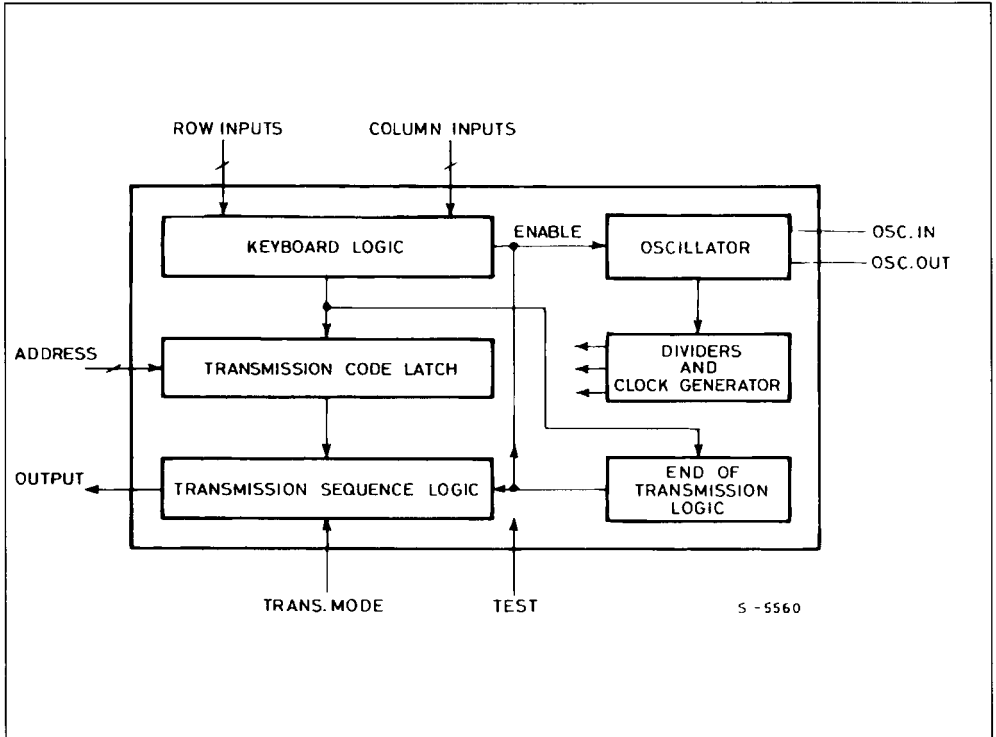

STATIC ELECTRICAL CHARACTERISTICS (over recommended operating conditions)

Typical values are at 9 V and $T_{amb} = 25\text{ }^{\circ}\text{C}$

Symbol	Parameter	Pins	Test Conditions		Value			Unit
					Min.	Typ.	Max.	
I_{DD}	Supply Voltage		$V_{DD} = 9\text{ V}$ IR Output Open	Stand-by		5	15	μA
				Operating (one key closed)		4	7	mA
I_{OH}	H State IR Output Current		$V_{DD} = 9\text{ V}$ $V_{OH} = 8\text{ V}$	-1.5	-2.5		mA	
			$V_{DD} = 4.5\text{ V}$ $V_{OH} = 3.5\text{ V}$	-0.3	-0.5		mA	
I_{OL}	L State IR Output Current		$V_{DD} = 9\text{ V}$ $V_{OL} = 1\text{ V}$	1.5	-2.5		mA	
			$V_{DD} = 4.5\text{ V}$ $V_{OL} = 1\text{ V}$	0.3	0.5		mA	
V_{TH}	Input Threshold High	Selection Inputs A to H	$V_{DD} = 9\text{ V}$			6	V	
			$V_{DD} = 4.5\text{ V}$			3		
V_{TL}	Input Threshold Low	Selection Inputs K to Q	$V_{DD} = 9\text{ V}$	3			V	
			$V_{DD} = 4.5\text{ V}$	1.5				
I_{IL}	Input Low Current	Pull-up Inputs A to H	$V_{DD} = 9\text{ V}$ $V_{IL} = 4.5\text{ V}$	-60		-300	μA	
I_{IH}	Input High Current	Pull-down Inputs K to Q	$V_{DD} = 9\text{ V}$ $V_{IH} = 4.5\text{ V}$	60		300	μA	
I_{IH}	Input High Current	Address Selection Inputs	$V_{DD} = 9\text{ V}$ $V_{IL} = 8.25\text{ V}$ (oscillator running)			150	μA	
I_L	Input Leakage Current	Trans. Mode Test Pin	$V_{DD} = 9\text{ V}$ $V_{IN} = 0\text{ to }9\text{ V}$			1	μA	
I_{OS}	Output Current	Osc. Out.	$V_{DD} = 9\text{ V}$ Osc. In. = V_{SS}	-2		-8	μA	

TRUTH TABLE

Command N°	Input Code										Command Bits						
	A	C	E	G	H	I	M	N	O	P	Q	C1	C2	C3	C4	C5	C6
0	END OF TRANSMISSION										0	0	0	0	0	0	0
1	X					X						1	0	0	0	0	0
2	X						X					1	1	0	0	0	0
3	X							X				0	0	1	0	0	0
4	X								X			1	0	1	0	0	0
5	X									X		0	1	1	0	0	0
6	X										X	1	1	1	0	0	0
7		X				X						1	0	0	0	1	0
8		X					X					1	1	0	0	1	0
9		X						X				0	0	1	0	1	0
10		X							X			1	0	1	0	1	0
11		X								X		0	1	1	0	1	0
12		X									X	1	1	1	0	1	0
13			X			X						1	0	0	0	0	1
14			X				X					1	1	0	0	0	1
15			X					X				0	0	1	0	0	1
16			X						X			1	0	1	0	0	1
17			X							X		0	1	1	0	0	1
18			X								X	1	1	1	0	0	1
19				X		X						1	0	0	0	1	1
20				X			X					1	1	0	0	1	1
21				X				X				0	0	1	0	1	1
22				X					X			1	0	1	0	1	1
23				X						X		0	1	1	0	1	1
24				X							X	1	1	1	0	1	1
25					X	X						1	0	0	1	1	1
26					X		X					1	1	0	1	1	1
27					X			X				0	0	1	1	1	1
28					X				X			1	0	1	1	1	1
29					X					X		0	1	1	1	1	1
30					X						X	1	1	1	1	1	1

DESCRIPTION

The signals are transmitted with infrared light using a Pulse Code Modulation. Each word consists of 12 bits. The binary information of a bit is determined by the time interval between two pulses. If "T" is the time base, the bits are coded as follows :

Odd bits (1, 3, etc)

0 = T

1 = 2T

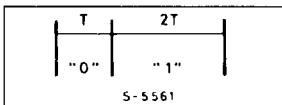

Even bits (2, 4, etc.)

0 = T

1 = 3T

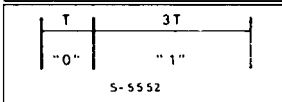

The different code introduced for the even and odd "1s" improves the capability to recognize false codes at the receiver end. For example the double error which can cause the exchange "10" with "01" is easily detected. A Parity bit is also added in order to further increase the reliability of the transmission. This bit is "1" if the number of transmitted "1" is even while it is "0" if the number of transmitted "1" is odd. In addition, every word contains a preliminary pulse, a start pulse and a stop pulse. The spacing between the preliminary and the start pulse is 4T. This is followed after 1T by 11 data pulses (one parity bit), and terminated after a 4T interval by a stop pulse. Consequently, a word in which the binary digit 0 occurs ten times has a total duration of 21T. A word containing ten "1s" has a duration of 36T.

Example :

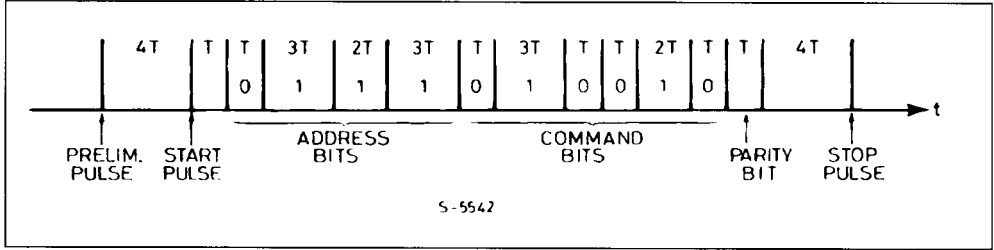

SYNCHRONIZATION BETWEEN TRANSMITTER AND RECEIVER

The transmitter and the receiver can operate with different reference frequencies. Typical values suitable for correct operation of the system should be comprised between 445 and 510 kHz, using a cheap ceramic resonator.

Synchronization between the transmitter and the receiver, necessary to obtain the above described wide range of frequency tolerance is achieved by measuring in the receiver the interval between the start pulse and the first data pulse, storing this value and using it as time base T.

KEYBOARD/CODE REPETITION

One column, input (pins IMNOPQ) has to be connected to one row (pins ACEGH) input to activate

the transmitter. The contact must be continuously closed for a minimum of 25 ms.

Double and multiple contact operations are not accepted. The command information is repeatedly transmitted at intervals of 102 ms ($f_{ref} = 500 \text{ kHz}$) as long as the push button remains operated. When the contact is interrupted the circuit transmits, after a pause of 18 ms, the "end of transmission code" and returns to stand-by mode. If the contact is interrupted while a command is being transmitted the circuit carries on with the transmission to the end. After a pause of about 18 ms it transmits the end of transmission code.

No command is accepted until the "end of transmission code" is over.

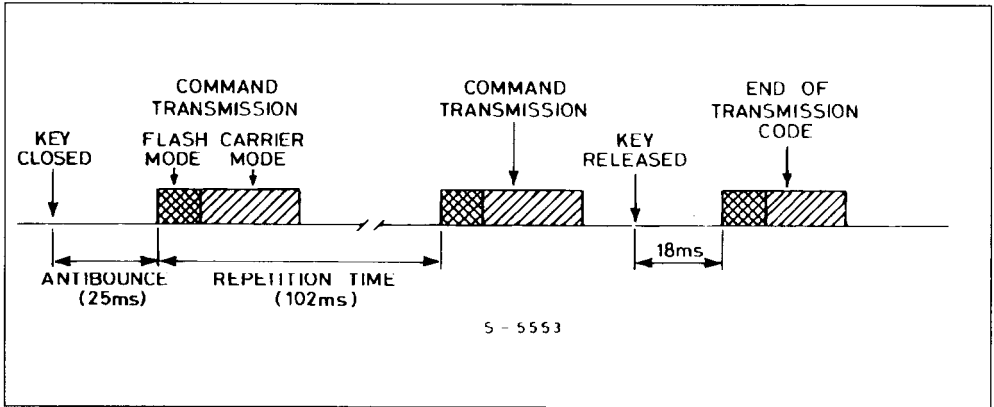

TRANSMISSION MODE (pin T)

The M708 can operate in Flash (pin T = V_{DD}) or Carrier (pin T = V_{SS}) transmission modes. Using a refer-

ence frequency of 500 kHz the output signal has these formats respectively :

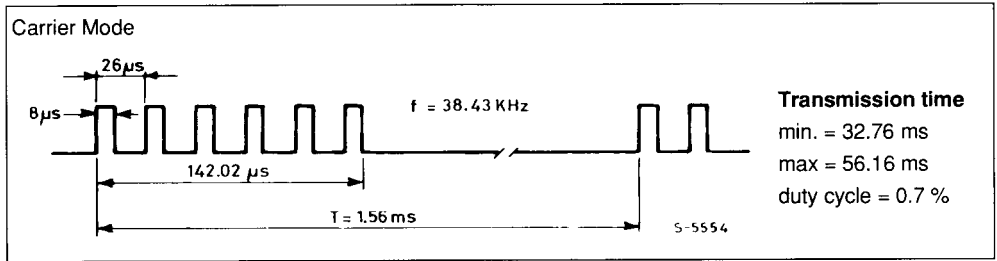
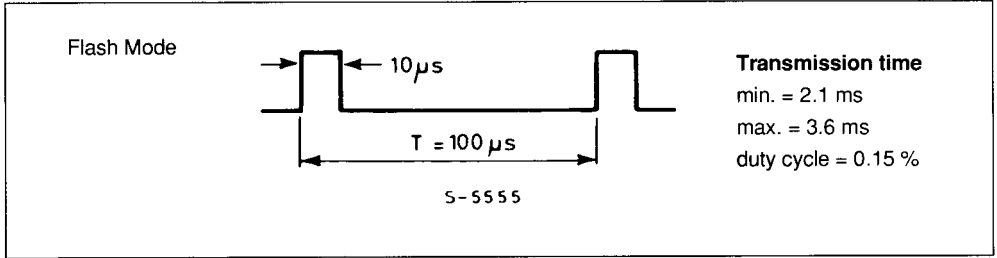

ADDRESS (pins X, Z)

The address information is coded and transmitted as follows.

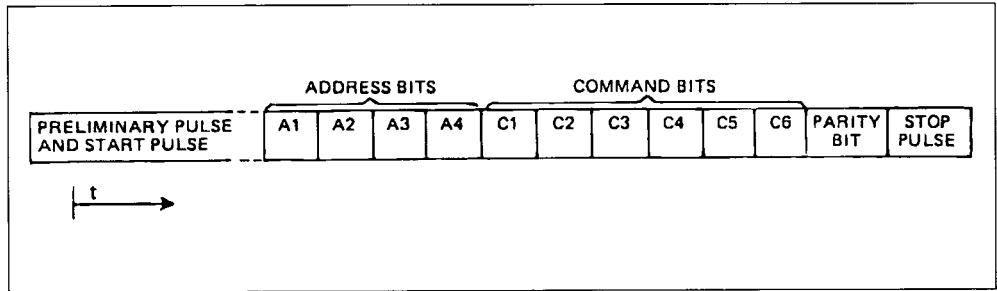

Address Number	Transmitted Code				Address Input Code	
	A1	A2	A3	A4	X	Z
1	0	0	0	0	L	L
2	1	0	0	0	H	L
9	0	0	0	1	L	H
10	1	0	0	1	H	H

The Address inputs have internal pull-downs which are disabled during stand-by.

Single address selection

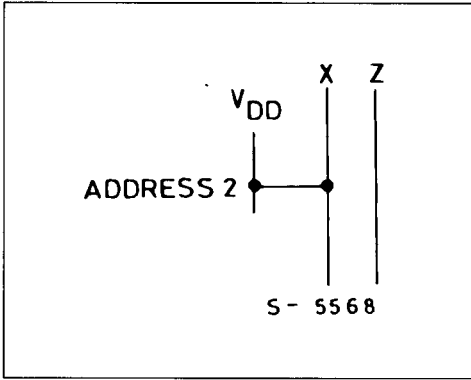

Multiple address selection

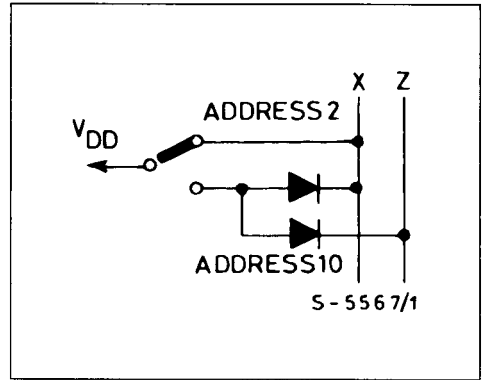

Note : Unused inputs can be left open or connected to V_{SS}.

TYPICAL APPLICATIONS

FLASH MODE

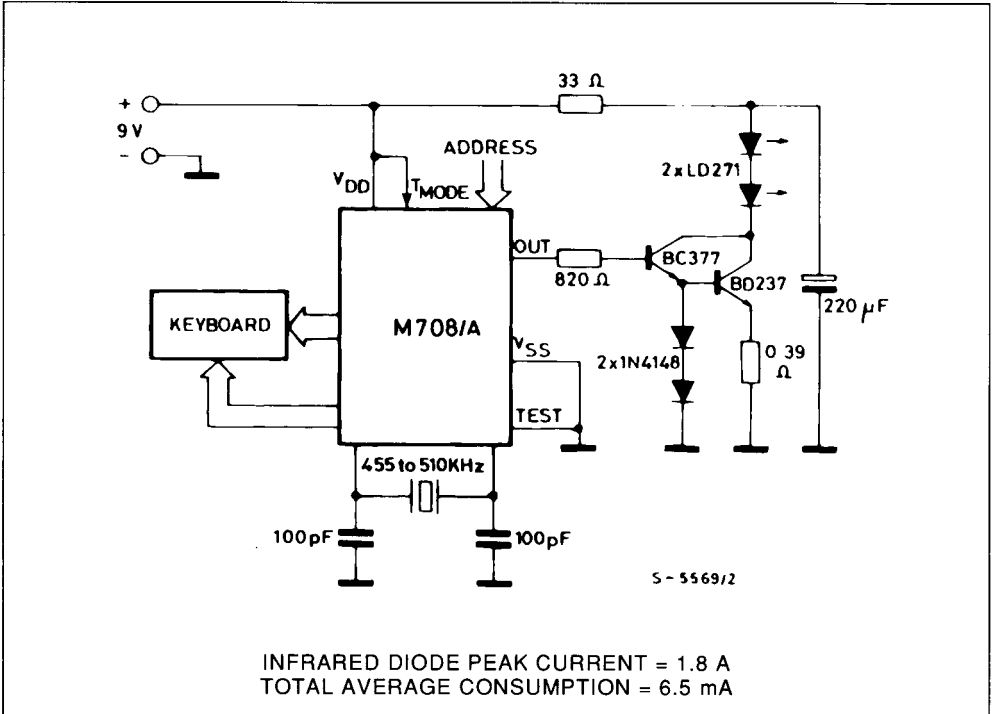

CARRIER MODE

