

LOW-NOISE VERTICAL DEFLECTION SYSTEM

- COMPLETE VERTICAL DEFLECTION SYSTEM
- LOW NOISE
- SUITABLE FOR HIGH DEFINITION MONITORS
- ESD PROTECTED

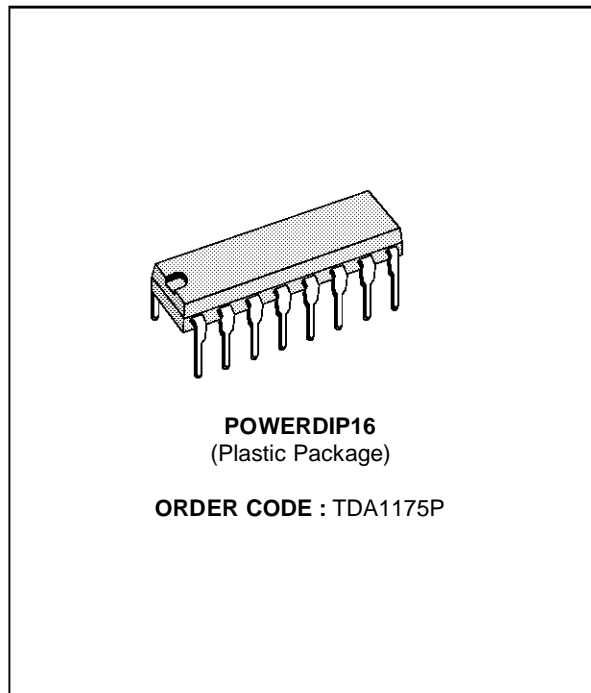

DESCRIPTION

The TDA1175P is a monolithic integrated circuit in POWERDIP16 plastic package. It is intended for use in black and white and colour TV receivers. Low-noise makes this device particularly suitable for use in monitors.

The functions incorporated are : synchronization circuit, oscillator and ramp generator, high power gain amplifier, flyback generator, voltage regulator.

PIN CONNECTIONS

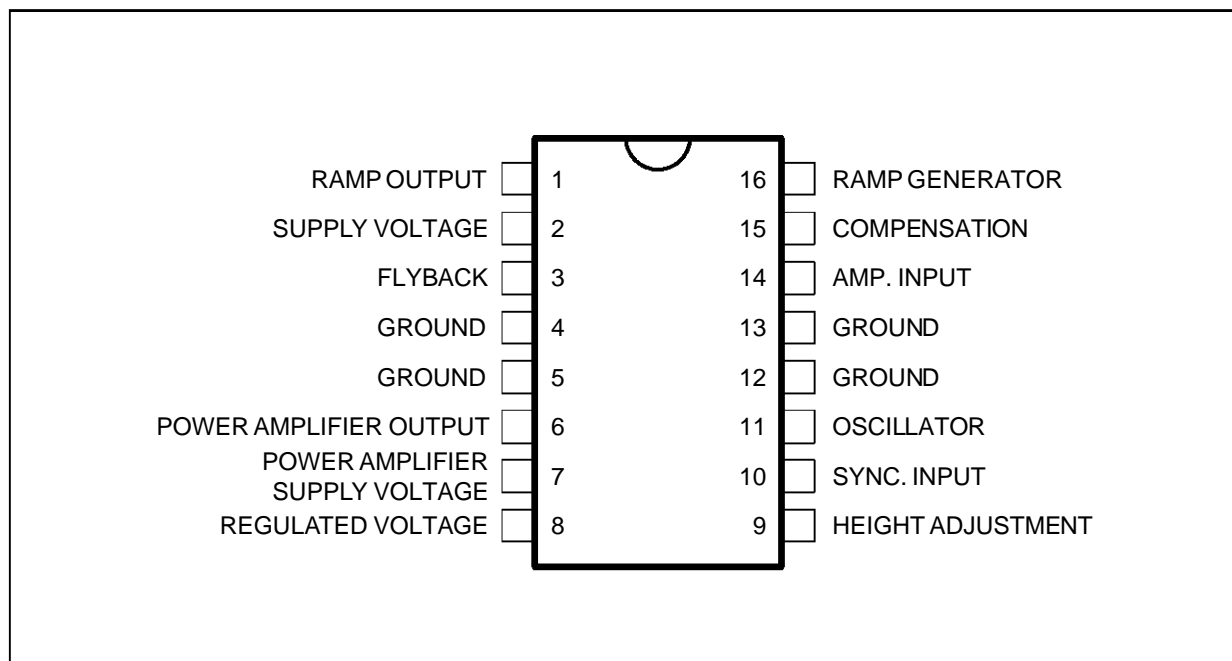

1175P-01 LEPS

BLOCK DIAGRAM

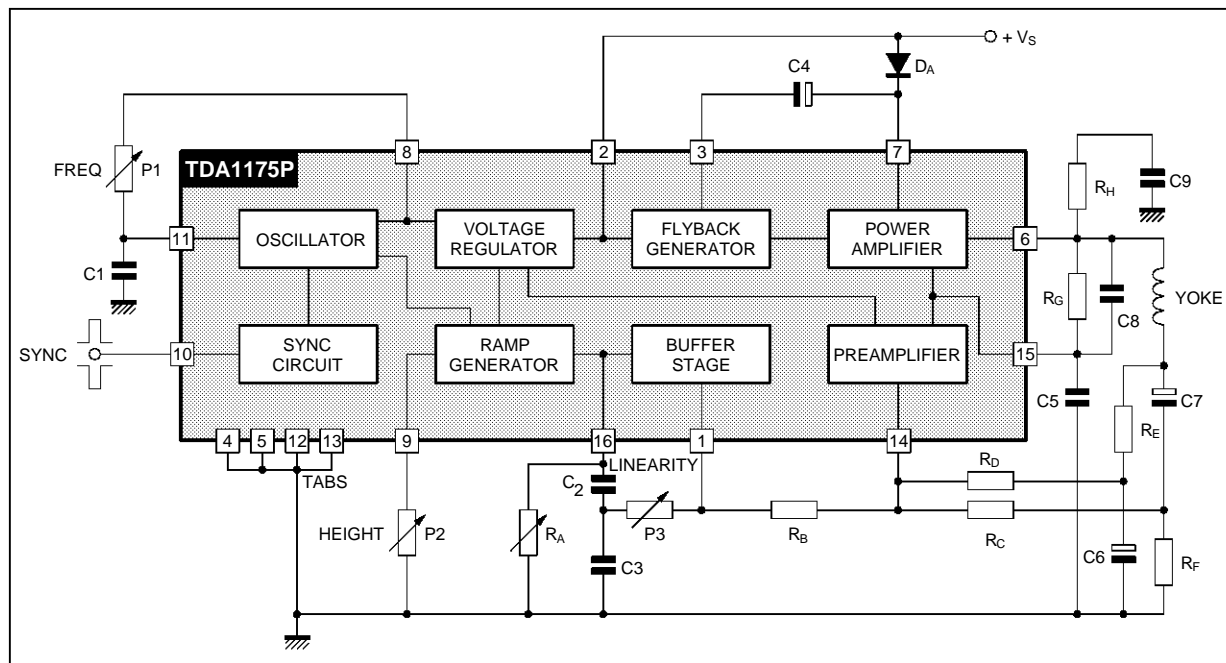

1175P-02.EPS

ABSOLUTE MAXIMUM RATINGS

Symbol	Parameter	Value	Unit
V_s	Supply Voltage at Pin 2	35	V
V_6, V_7	Flyback Peak Voltage	60	V
V_{14}	Power Amplifier Input Voltage	+ 10 - 0.5	V
I_o	Output Peak Current (non repetitive) at $t = 2ms$	2	A
I_o	Output Peak Current at $f = 50Hz, t \leq 10\mu s$	2.5	A
I_o	Output Peak Current at $f = 50Hz, t > 10\mu s$	1.5	A
I_3	Pin 3 DC Current at $V_6 < V_2$	100	mA
I_3	Pin 3 Peak to Peak Flyback Current for $f = 50Hz, t_{fly} \leq 1.5ms$	1.8	A
I_{10}	Pin 10 Current	± 20	mA
P_{tot}	Power Dissipation : at $T_{tab} = 90^\circ C$ at $T_{amb} = 70^\circ C$ (free air) (1)	4.3 1	W
T_{stg}, T_j	Storage and Junction Temperature	- 40, + 150	$^\circ C$

1175P-01.TBL

THERMAL DATA

Symbol	Parameter	Value	Unit
$R_{th(j-tab)}$	Thermal Resistance Junction-pin	Max. 12	$^\circ C/W$
$R_{th(j-amb)}$	Thermal Resistance Junction-ambient	Max. 80	$^\circ C/W^{(1)}$

(1) Obtained with tabs soldered to printed circuit with minimized copper area.

1175P-02.TBL

ELECTRICAL CHARACTERISTICS ($T_{amb} = 25\text{ }^{\circ}\text{C}$, unless otherwise specified)

Symbol	Parameter	Test Conditions	Min.	Typ.	Max.	Unit	Fig.
DC CHARACTERISTICS (Refer to the test circuits, $V_S = 35\text{V}$)							
I_2	Pin 2 Quiescent Current	$I_3 = 0$		7	14	mA	1b
I_7	Pin 7 Quiescent Current	$I_6 = 0$		8	17	mA	1b
$-I_{11}$	Oscillator Bias Current	$V_{11} = 1\text{V}$		0.1	1	μA	1a
$-I_{14}$	Amplifier Input Bias Current	$V_{14} = 1\text{V}$		1	10	μA	1b
$-I_{16}$	Ramp Generator Bias Current	$V_{16} = 0$		0.02	0.3	μA	1a
$-I_{16}$	Ramp Generator Current	$I_9 = 20\mu\text{A}$, $V_{16} = 0$	18.5	20	21.5	μA	1b
$\frac{\Delta I_{16}}{I_{16}}$	Ramp Generator Non-linearity	$\Delta V_{16} = 0$ to 12V , $I_9 = 20\mu\text{A}$		0.2	1	%	1b
V_S	Supply Voltage Range		10		35	V	
V_1	Pin 1 Saturation Voltage to Ground	$I_1 = 1\text{mA}$		1	1.4	V	
V_3	Pin 3 Saturation Voltage to Ground	$I_3 = 10\text{mA}$		1.5	2.5	V	1a
V_6	Quiescent output Voltage	$V_S = 10\text{V}$, $R_1 = 1\text{k}\Omega$, $R_2 = 1\text{k}\Omega$ $V_S = 35\text{V}$, $R_1 = 3\text{k}\Omega$, $R_2 = 1\text{k}\Omega$	4.1 8.2	4.4 8.8	4.7 9.4	V V	1a 1a
V_{6L}	Output Saturation Voltage to Ground	$-I_6 = 0.1\text{A}$ $-I_6 = 0.8\text{A}$		0.9 1.8	1.2 2.2	V v	1c 1c
V_{6H}	Output Saturation Voltage to Supply	$I_6 = 0.1\text{A}$ $I_6 = 0.8\text{A}$		1.4 2.8	2.1 3.1	V V	1d 1d
V_8	Regulated Voltage at Pin 8		6.5	6.7	6.9	V	1b
V_9	Regulated Voltage at Pin 9	$I_9 = 20\mu\text{A}$	6.6	6.8	7	V	1b
$\frac{ \Delta V_8 }{\Delta V_S}$, $\frac{ \Delta V_9 }{\Delta V_S}$	Regulated Voltage Drift with Supply Voltage	$\Delta V_S = 10$ to 35V		1	2	mV/V	1b
V_{14}	Amplifier Input Reference Voltage	$V_{10} \leq 0.4\text{V}$	2.20	2.27	2.35	V	

AC CHARACTERISTICS (Refer to the AC test circuit, $V_S = 22\text{V}$, $f = 50\text{Hz}$)

I_S	Supply Current	$I_Y = 1A_{PP}$		140		mA	2
I_{10}	Sync. Input Current (positive or negative)		0.5		2	mA	2
V_6	Flyback Voltage	$I_Y = 1A_{PP}$		45		V	2
t_{fly}	Flyback Time	$I_Y = 1A_{PP}$		0.7		ms	2
V_{ON}	Peak to Peak Output Noise	Pin 11 Connected to GND		18	30	mVpp	2
f_o	Free Running Frequency	$(P1 + R1) = 300\text{k}\Omega$ $C9 = 0.1\mu\text{F}$	36	43.5		Hz	2
f_{OPER}	Operating Frequency Range		10		120	Hz	2
Δf	Synchronization Range	$I_{10} = 0.5\text{mA}$, $C9 = 0.1\mu\text{F}$ $(P1+R1) = 300\text{k}\Omega$	14			Hz	2
$\frac{\Delta f}{\Delta V_S}$	Frequency Drift with Supply Voltage	$V_S = 10$ to 35V		0.005		Hz/V	2
$\frac{ \Delta f }{\Delta T_{ab}}$	Frequency Drift with tab Temperature	$T_{tab} = 40$ to 120°C		0.01		Hz/ $^{\circ}\text{C}$	2

1175P-03.TBL

Figure 1 : DC Test Circuits

Figure 1a

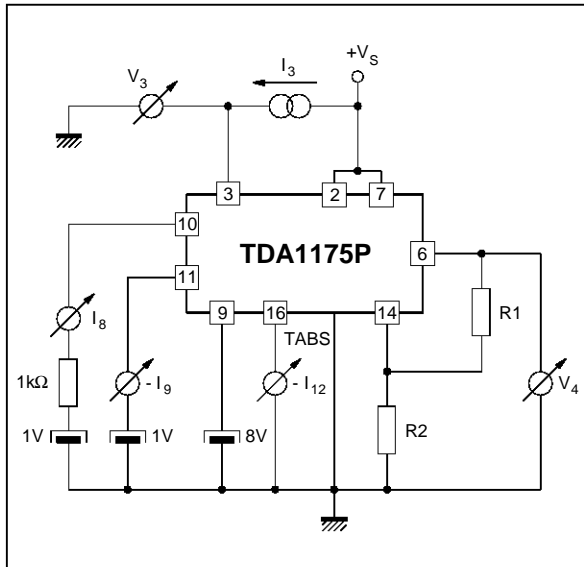

1175P-03.EPS

Figure 1b

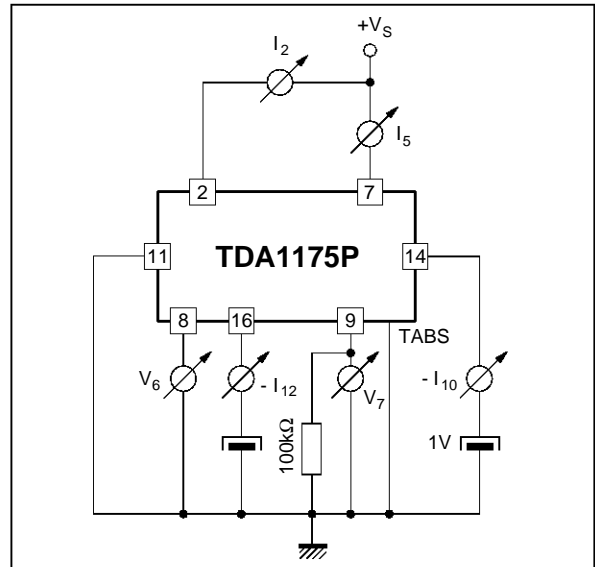

1175P-04.EPS

Figure 1c

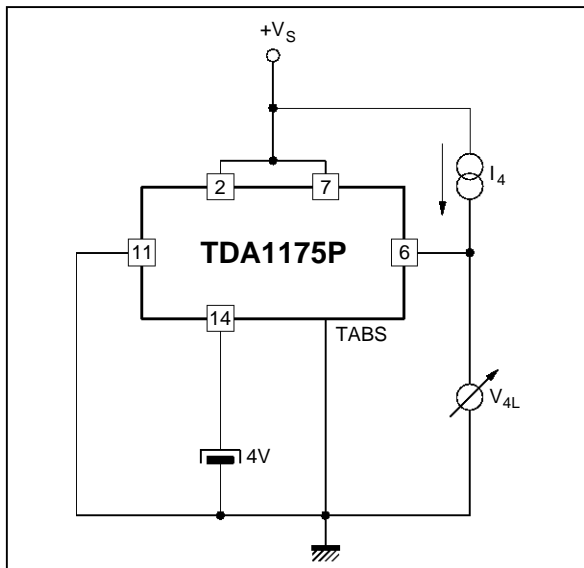

1175P-05.EPS

Figure 1d

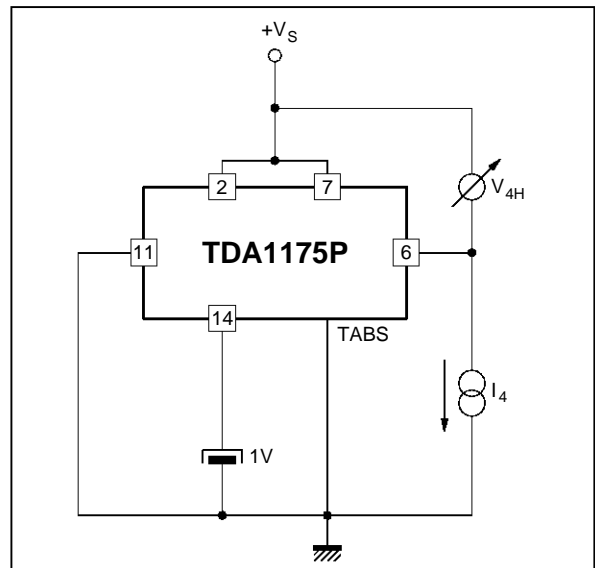

1175P-06.EPS

Figure 2 : AC Test and Application Circuit for Large Screen B/W TV Set 10Ω/20mH/1A_{PP}

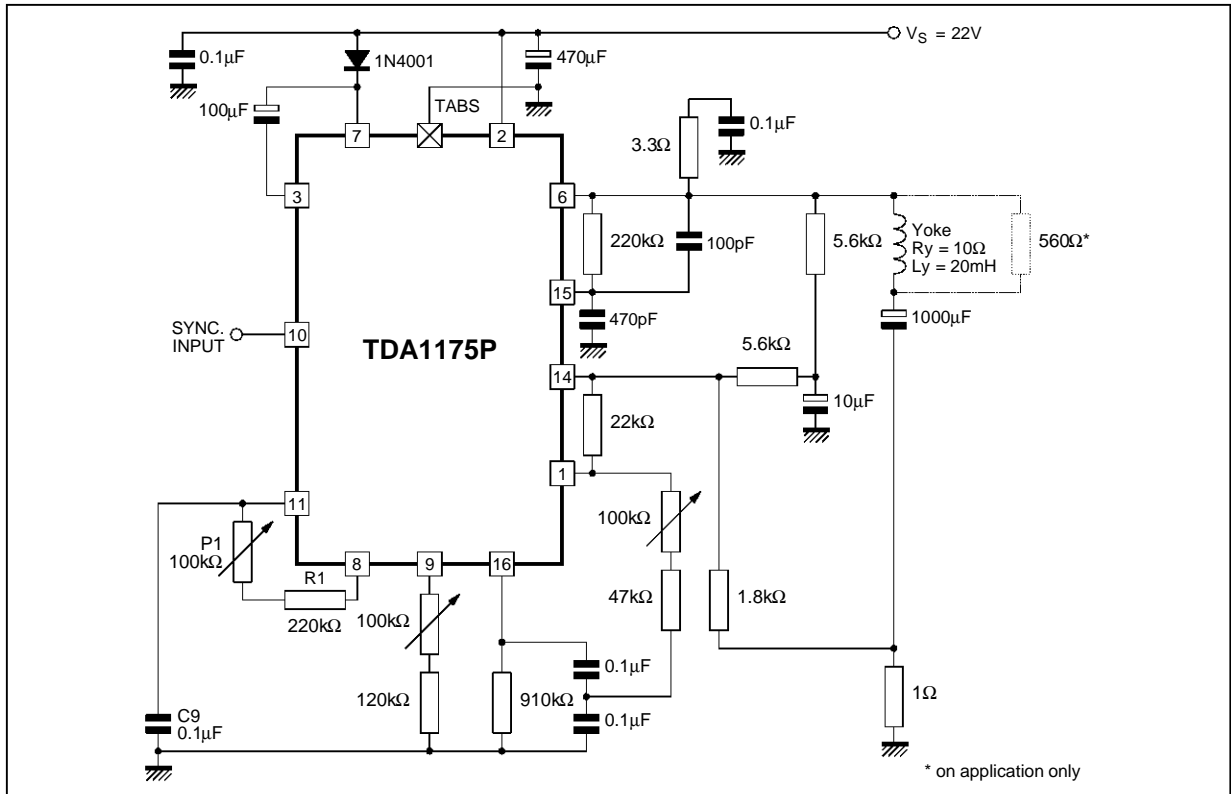

1175P-07.EPS

Figure 3 : Typical Application Circuit for VGA Monitor (R_Y = 10Ω, L_Y = 20mH, I_Y = 0.8A_{PP})

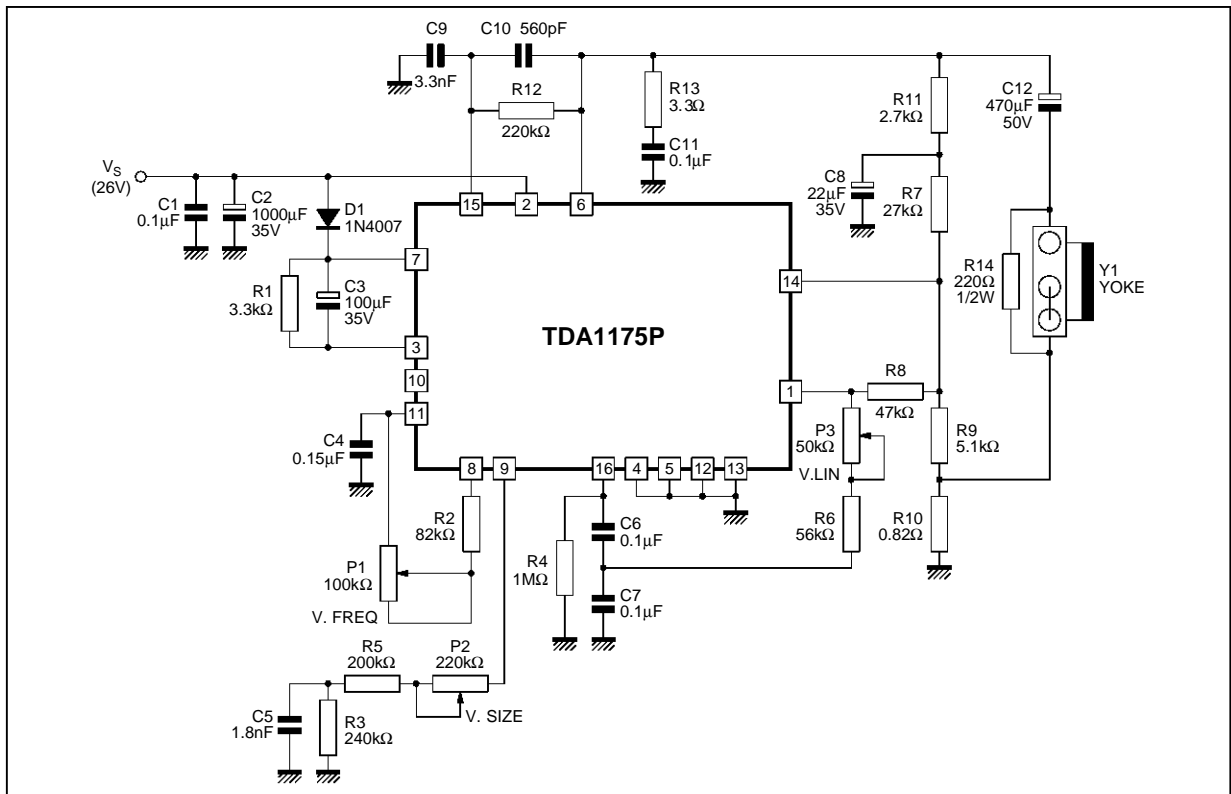

1175P-08.EPS

Figure 4 : P.C. Board and Components Layout of the Circuit of Figure 3 (1:1 scale)

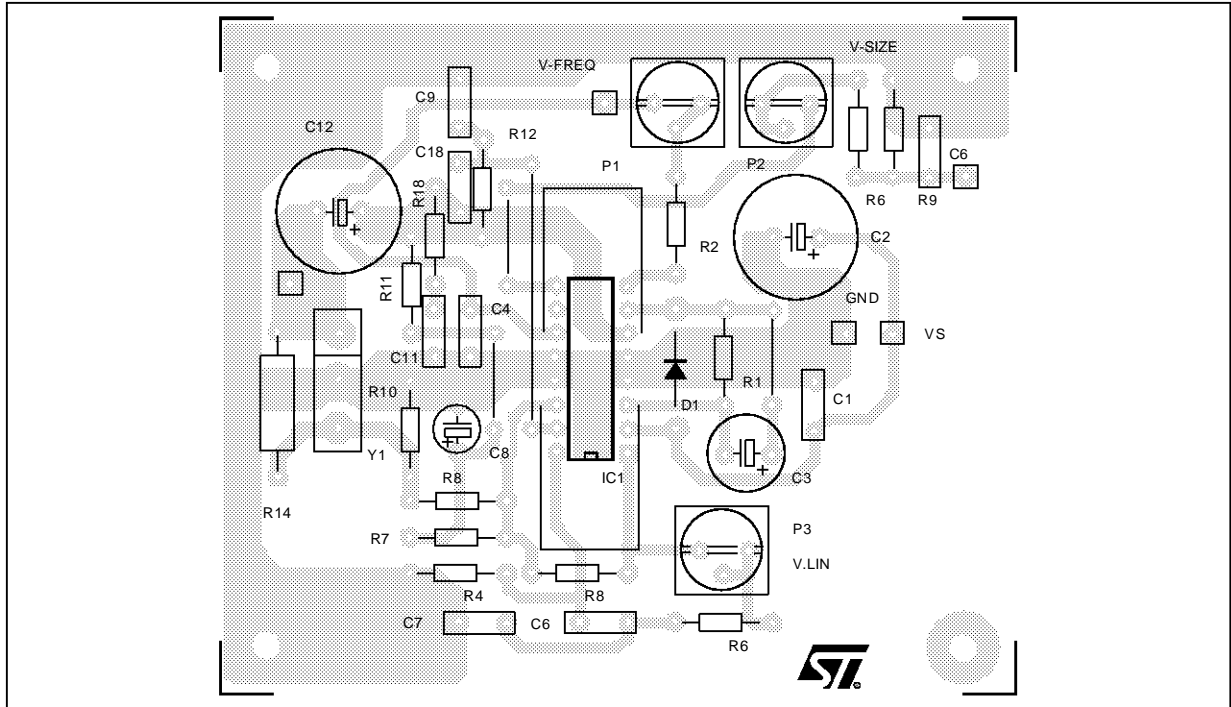

1175P-09.EPS

BILL OF MATERIAL

Item	Qty	Reference	Part
1	4	C1, C6, C7, C11	0.1μF
2	1	C2	1000μF 35V
3	1	C3	100μF 35V
4	1	C4	0.15μF
5	1	C5	1.8nF
6	1	C8	22μF 35V
7	1	C9	3.3nF
8	1	C10	560pF
9	1	C12	470μF 50V
10	1	D1	1N4007
11	1	IC1	TDA1175P
12	1	P1	100kΩ POT
13	1	P2	220kΩ POT
14	1	P3	50kΩPOT
15	1	R1	3.3kΩ

Item	Qty	Reference	Part
16	1	R2	82kΩ
17	1	R3	240kΩ
18	1	R4	1MΩ
19	1	R5	200kΩ
20	1	R6	56kΩ
21	1	R7	27kΩ
22	1	R8	47kΩ
23	1	R9	5.1kΩ
24	1	R10	0.82Ω
25	1	R11	2.7kΩ
26	1	R12	220kΩ
27	1	R13	3.3Ω
28	1	R14	220Ω 1/2W
29	1	Y1	YOKE

1175P-04.TBL

MOUNTING INSTRUCTION

The $R_{th(j-a)}$ can be reduced by soldering the GND pins to a suitable copper area of the printed circuit board (Figure 5) or to an external heatsink (Figure 6).

The diagram of Figure 7 shows the maximum dissippable power P_{tot} and the $R_{th(j-a)}$ as a function of the side "l" of two equal square copper areas

Figure 5 : Example of P.C. Board Copper Area

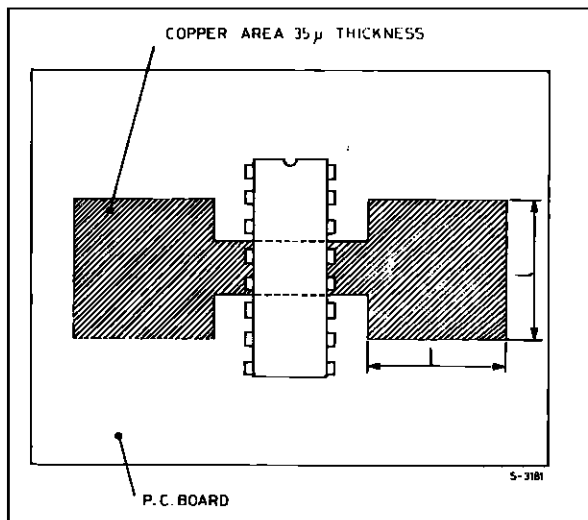
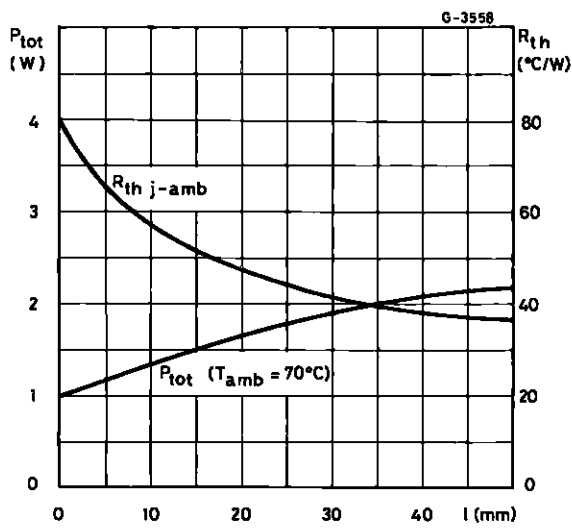

Figure 7 : Maximum Power Dissipation and Junction-ambient Thermal Resistance versus "l"



having a thickness of 35μ (1.4 mils).

During soldering the pins temperature must not exceed 260°C and the soldering time must not be longer than 12 seconds.

The external heatsink or printed circuit copper area must be connected to electrical ground.

Figure 6 : External Heatsink Mounting Example

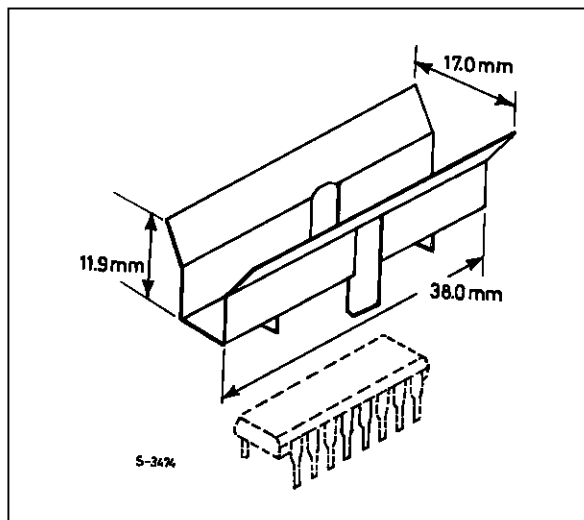
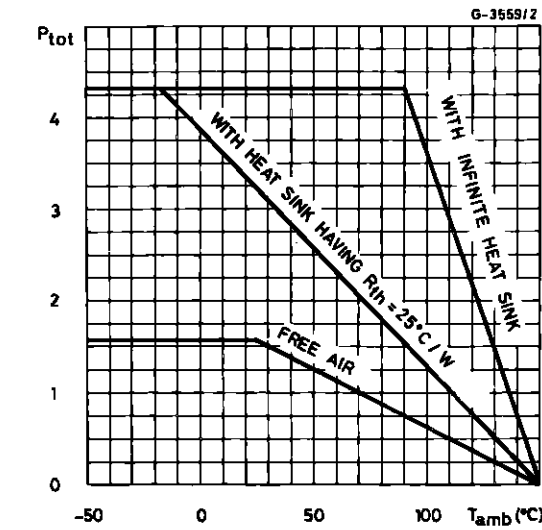
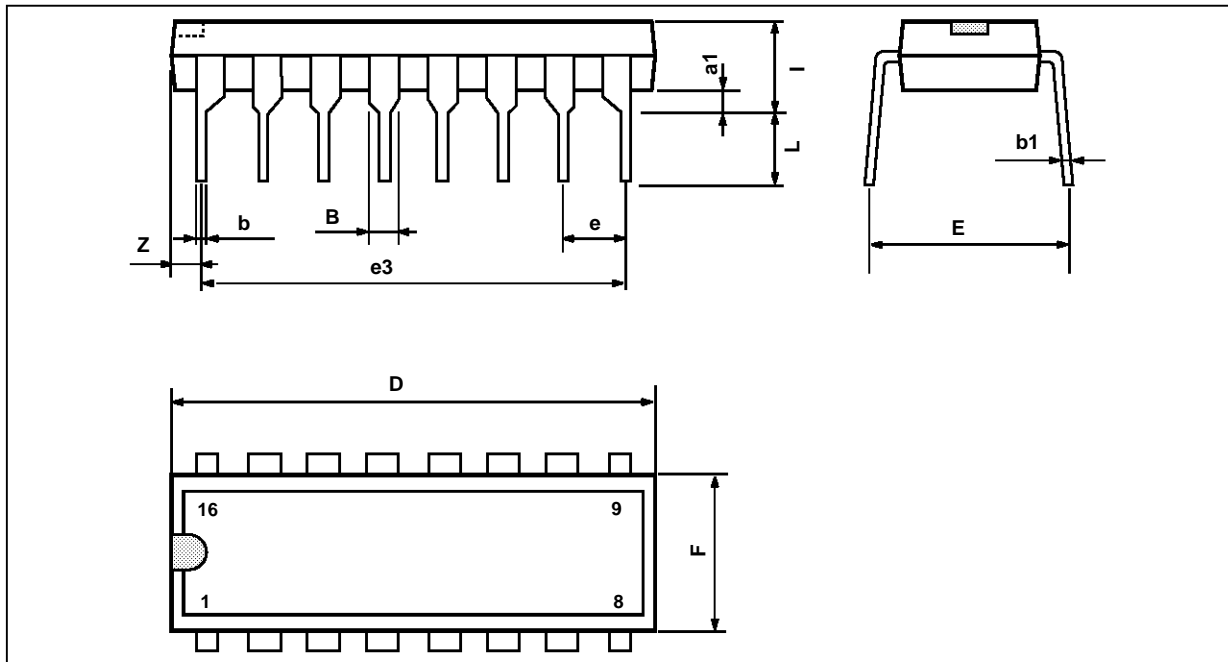

Figure 8 : Maximum Allowable Power Dissipation versus Ambient Temperature



PACKAGE MECHANICAL DATA
16 PINS - PLASTIC POWERDIP



PMDIP16W/EP5

Dimensions	Millimeters			Inches		
	Min.	Typ.	Max.	Min.	Typ.	Max.
a1	0.51			0.020		
B	0.85		1.4	0.033		0.055
b		0.5			0.020	
b1	0.38		0.5	0.015		0.020
D			20			0.787
E		8.8			0.346	
e		2.54			0.100	
e3		17.78			0.700	
F			7.1			0.280
i			5.1			0.201
L		3.3			0.130	
Z			1.27			0.050

DIP16PW/TBL

Information furnished is believed to be accurate and reliable. However, SGS-THOMSON Microelectronics assumes no responsibility for the consequences of use of such information nor for any infringement of patents or other rights of third parties which may result from its use. No licence is granted by implication or otherwise under any patent or patent rights of SGS-THOMSON Microelectronics. Specifications mentioned in this publication are subject to change without notice. This publication supersedes and replaces all information previously supplied. SGS-THOMSON Microelectronics products are not authorized for use as critical components in life support devices or systems without express written approval of SGS-THOMSON Microelectronics.

© 1995 SGS-THOMSON Microelectronics - All Rights Reserved

Purchase of I²C Components of SGS-THOMSON Microelectronics, conveys a license under the Philips I²C Patent. Rights to use these components in a I²C system, is granted provided that the system conforms to the I²C Standard Specifications as defined by Philips.

SGS-THOMSON Microelectronics GROUP OF COMPANIES

Australia - Brazil - China - France - Germany - Hong Kong - Italy - Japan - Korea - Malaysia - Malta - Morocco
The Netherlands - Singapore - Spain - Sweden - Switzerland - Taiwan - Thailand - United Kingdom - U.S.A.