



# Z04 Series

STANDARD

4A TRIACs

## MAIN FEATURES:

Symbol	Value	Unit
$I_{T(RMS)}$	4	A
$V_{DRM}/V_{RRM}$	600 to 800	V
$I_{GT}(Q_1)$	3 to 25	mA

## DESCRIPTION

The Z04 series is suitable for general purpose AC switching applications. They can be found in applications such as touch light dimmers, fan controllers, HID lamp ignitors,...

Different gate current sensitivities are available, allowing optimized performances when controlled directly from microcontrollers.

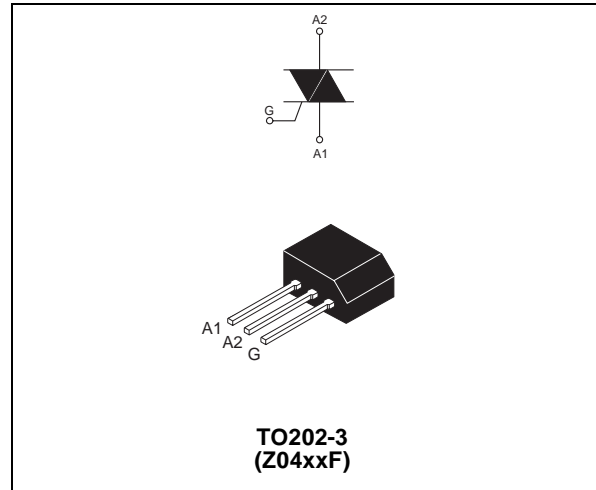

## ABSOLUTE MAXIMUM RATINGS

Symbol	Parameter		Value	Unit
$I_{T(RMS)}$	RMS on-state current (full sine wave)	$T_I = 30^\circ\text{C}$	4	A
		$T_{amb} = 25^\circ\text{C}$	1	
$I_{TSM}$	Non repetitive surge peak on-state current (full cycle, $T_j$ initial = $25^\circ\text{C}$ )	$F = 50\text{ Hz}$ $t = 20\text{ ms}$	20	A
		$F = 60\text{ Hz}$ $t = 16.7\text{ ms}$	21	
$I^2t$	$I^2t$ Value for fusing	$t_p = 10\text{ ms}$	2.2	$\text{A}^2\text{s}$
$di/dt$	Critical rate of rise of on-state current $I_G = 2 \times I_{GT}$ , $t_r \leq 100\text{ ns}$	$F = 120\text{ Hz}$ $T_j = 125^\circ\text{C}$	20	$\text{A}/\mu\text{s}$
$I_{GM}$	Peak gate current	$t_p = 20\text{ }\mu\text{s}$ $T_j = 125^\circ\text{C}$	1.2	A
$P_{G(AV)}$	Average gate power dissipation	$T_j = 125^\circ\text{C}$	0.2	W
$T_{stg}$ $T_j$	Storage junction temperature range Operating junction temperature range		- 40 to + 150 - 40 to + 125	$^\circ\text{C}$

## Z04 Series

### ELECTRICAL CHARACTERISTICS (T<sub>j</sub> = 25°C, unless otherwise specified)

Symbol	Test Conditions	Quadrant		Z04xx				Unit
				02	05	09	10	
I <sub>GT</sub> (1)	V <sub>D</sub> = 12 V    R <sub>L</sub> = 30 Ω	ALL	MAX.	3	5	10	25	mA
V <sub>GT</sub>		ALL	MAX.	1.3				V
V <sub>GD</sub>	V <sub>D</sub> = V <sub>DRM</sub> R <sub>L</sub> = 3.3 kΩ    T <sub>j</sub> = 125°C	ALL	MIN.	0.2				V
I <sub>H</sub> (2)	I <sub>T</sub> = 50 mA		MAX.	3	5	10	25	mA
I <sub>L</sub>	I <sub>G</sub> = 1.2 I <sub>GT</sub>	I - III - IV	MAX.	6	10	15	25	mA
		II		12	15	25	50	
dV/dt (2)	V <sub>D</sub> = 67 %V <sub>DRM</sub> gate open    T <sub>j</sub> = 110°C		MIN.	10	20	100	200	V/μs
(dV/dt) <sub>c</sub> (2)	(dI/dt) <sub>c</sub> = 1.8 A/ms    T <sub>j</sub> = 110°C		MIN.	0.5	1	2	5	V/μs

### STATIC CHARACTERISTICS

Symbol	Test Conditions		Value	Unit	
V <sub>TM</sub> (2)	I <sub>TM</sub> = 5.5 A    t <sub>p</sub> = 380 μs	T <sub>j</sub> = 25°C	MAX.	2.0	V
V <sub>to</sub> (2)	Threshold voltage	T <sub>j</sub> = 125°C	MAX.	0.95	V
R <sub>d</sub> (2)	Dynamic resistance	T <sub>j</sub> = 125°C	MAX.	180	mΩ
I <sub>DRM</sub>	V <sub>DRM</sub> = V <sub>RRM</sub>	T <sub>j</sub> = 25°C	MAX.	5	μA
I <sub>RRM</sub>		T <sub>j</sub> = 125°C		0.5	mA

**Note 1:** minimum I<sub>GT</sub> is guaranteed at 5% of I<sub>GT</sub> max.

**Note 2:** for both polarities of A2 referenced to A1

### THERMAL RESISTANCES

Symbol	Parameter	Value	Unit
R <sub>th(j-l)</sub>	Junction to lead (AC)	15	°C/W
R <sub>th(j-a)</sub>	Junction to ambient	100	°C/W

**PRODUCT SELECTOR**

Part Number	Voltage			Sensitivity	Type	Package
	600 V	700 V	800 V			
Z0402MF	X			3 mA	Standard	TO202-3
Z0402SF		X		3 mA	Standard	TO202-3
Z0402NF			X	3 mA	Standard	TO202-3
Z0405MF	X			5 mA	Standard	TO202-3
Z0405SF		X		5 mA	Standard	TO202-3
Z0405NF			X	5 mA	Standard	TO202-3
Z0409MF	X			10 mA	Standard	TO202-3
Z0409SF		X		10 mA	Standard	TO202-3
Z0409NF			X	10 mA	Standard	TO202-3
Z0410MF	X			25 mA	Standard	TO202-3
Z0410SF		X		25 mA	Standard	TO202-3
Z0410NF			X	25 mA	Standard	TO202-3

**ORDERING INFORMATION**

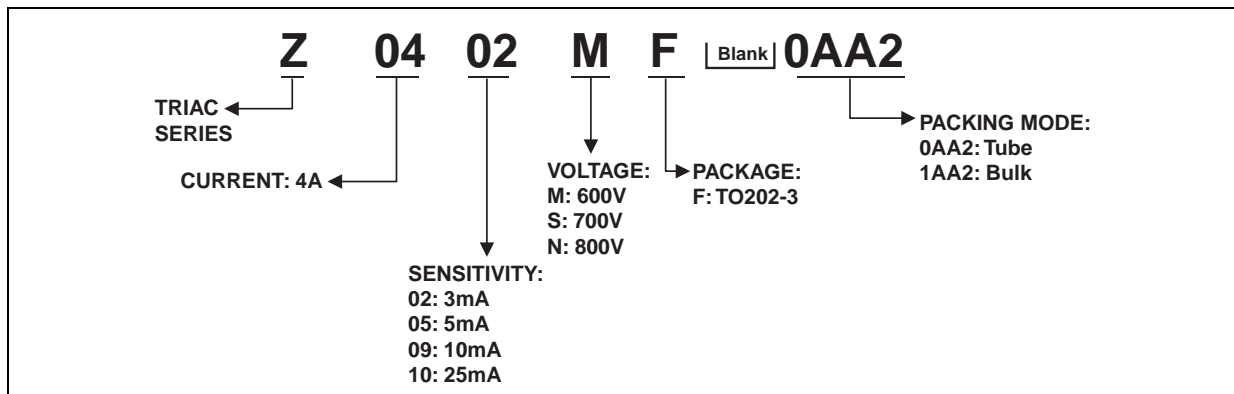

**OTHER INFORMATION**

Part Number	Marking	Weight	Base quantity	Packing mode
Z04xxyF 0AA2	Z04xxyF	0.8 g	50	Tube
Z04xxyF 1AA2	Z04xxyF	0.8 g	250	Bulk

Note: xx = sensitivity, y = voltage

**Fig. 1:** Maximum power dissipation versus RMS on-state current (full cycle).

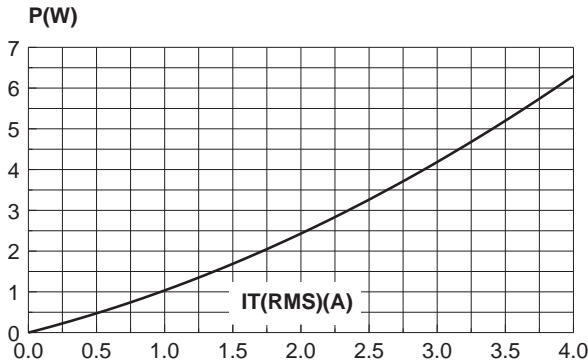

**Fig. 3:** Relative variation of thermal impedance junction to ambient versus pulse duration.

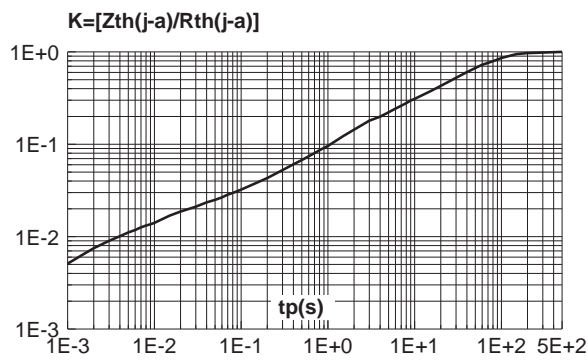

**Fig. 5:** Surge peak on-state current versus number of cycles.

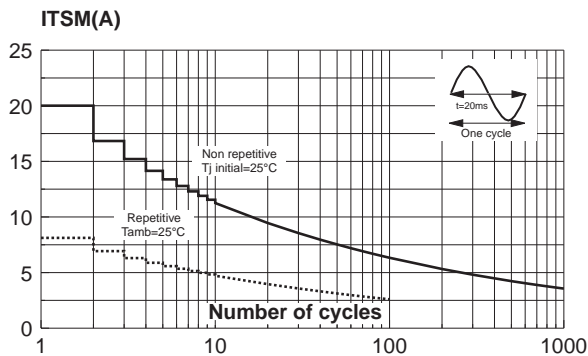

**Fig. 2:** RMS on-state current versus ambient temperature (full cycle).

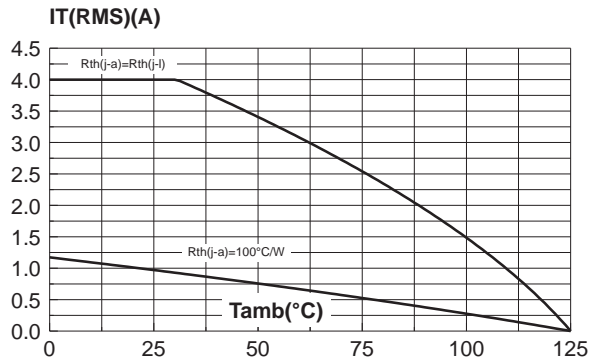

**Fig. 4:** Relative variation of gate trigger current, holding current and latching current versus junction temperature (typical values).

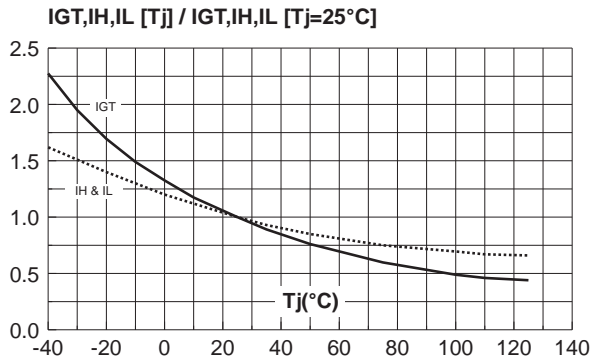

**Fig. 6:** Non-repetitive surge peak on-state current for a sinusoidal pulse with width  $t_p < 10\text{ms}$ , and corresponding value of  $I^2t$ .

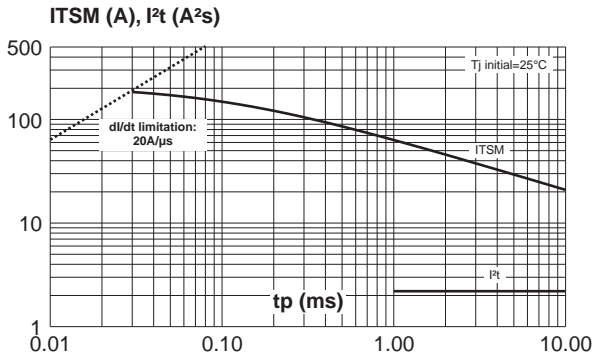

**Fig. 7:** On-state characteristics (maximum values).

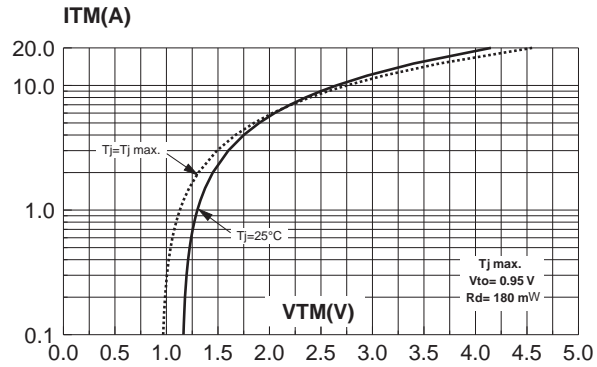

**Fig. 8:** Relative variation of critical rate of decrease of main current versus  $(dV/dt)_c$  (typical values).

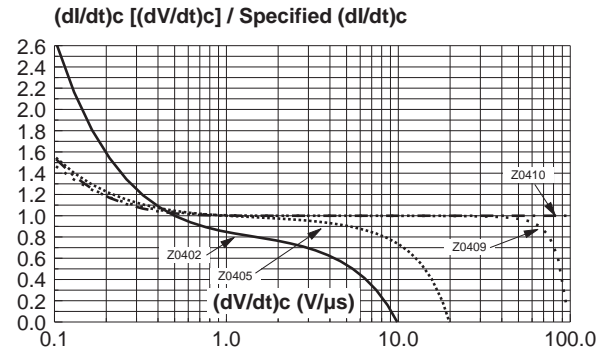

**Fig. 9:** Relative variation of critical rate of decrease of main current versus junction temperature.

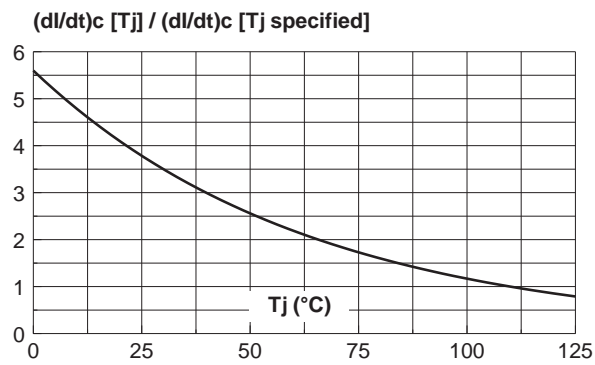

## Z04 Series

### PACKAGE MECHANICAL DATA

TO202-3 (Plastic)

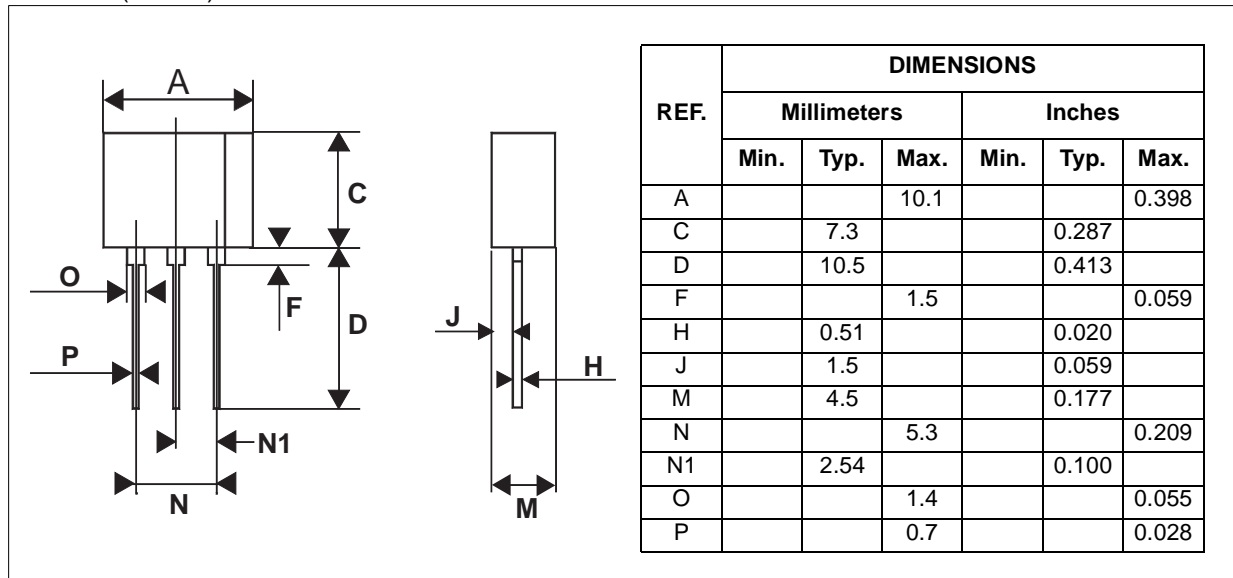

Information furnished is believed to be accurate and reliable. However, STMicroelectronics assumes no responsibility for the consequences of use of such information nor for any infringement of patents or other rights of third parties which may result from its use. No license is granted by implication or otherwise under any patent or patent rights of STMicroelectronics. Specifications mentioned in this publication are subject to change without notice. This publication supersedes and replaces all information previously supplied. STMicroelectronics products are not authorized for use as critical components in life support devices or systems without express written approval of STMicroelectronics.

© The ST logo is a registered trademark of STMicroelectronics

© 2001 STMicroelectronics - Printed in Italy - All Rights Reserved

STMicroelectronics GROUP OF COMPANIES

Australia - Brazil - China - Finland - France - Germany - Hong Kong - India - Italy - Japan - Malaysia  
Malta - Morocco - Singapore - Spain - Sweden - Switzerland - United Kingdom - U.S.A

<http://www.st.com>