

BB602M

Build in Biasing Circuit MOS FET IC
UHF RF Amplifier

HITACHI

ADE-208-815D (Z)

5th. Edition

Dec. 2000

Features

- Build in Biasing Circuit; To reduce using parts cost & PC board space.
- Low noise; NF = 1.6 dB typ. at f =900 MHz
- High gain; PG = 22 dB typ. at f = 900 MHz
- Withstanding to ESD;
Build in ESD absorbing diode. Withstand up to 200 V at C = 200 pF, Rs = 0 conditions.
- Provide mini mold packages; MPAK-4R(SOT-143var.)

Outline

MPAK-4R

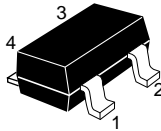

1. Source
2. Drain
3. Gate2
4. Gate1

- Notes:
1. Marking is "BT-".
 2. BB602M is individual type number of HITACHI BBFET.

Absolute Maximum Ratings (Ta = 25°C)

Item	Symbol	Ratings	Unit
Drain to source voltage	V_{DS}	6	V
Gate1 to source voltage	V_{G1S}	+6 -0	V
Gate2 to source voltage	V_{G2S}	+6 -0	V
Drain current	I_D	20	mA
Channel power dissipation	Pch	150	mW
Channel temperature	Tch	150	°C
Storage temperature	Tstg	-55 to +150	°C

Electrical Characteristics (Ta = 25°C)

Item	Symbol	Min	Typ	Max	Unit	Test Conditions
Drain to source breakdown voltage	$V_{(BR)DSS}$	6	—	—	V	$I_D = 200\mu A, V_{G1S} = V_{G2S} = 0$
Gate1 to source breakdown voltage	$V_{(BR)G1SS}$	+6	—	—	V	$I_{G1} = +10\mu A, V_{G2S} = V_{DS} = 0$
Gate2 to source breakdown voltage	$V_{(BR)G2SS}$	+6	—	—	V	$I_{G2} = +10\mu A, V_{G1S} = V_{DS} = 0$
Gate1 to source cutoff current	I_{G1SS}	—	—	+100	nA	$V_{G1S} = +5V, V_{G2S} = V_{DS} = 0$
Gate2 to source cutoff current	I_{G2SS}	—	—	+100	nA	$V_{G2S} = +5V, V_{G1S} = V_{DS} = 0$
Gate1 to source cutoff voltage	$V_{G1S(off)}$	0.5	0.7	1.0	V	$V_{DS} = 5V, V_{G2S} = 4V, I_D = 100\mu A$
Gate2 to source cutoff voltage	$V_{G2S(off)}$	0.5	0.7	1.0	V	$V_{DS} = 5V, V_{G1S} = 5V, I_D = 100\mu A$
Drain current	$I_{D(op)}$	8	11	14	mA	$V_{DS} = 5V, V_{G1} = 5V$ $V_{G2S} = 4V, R_G = 180k\Omega$
Forward transfer admittance	$ y_{fs} $	20	25	30	mS	$V_{DS} = 5V, V_{G1} = 5V, V_{G2S} = 4V$ $R_G = 180k\Omega, f = 1kHz$
Input capacitance	Ciss	1.4	1.7	2.0	pF	$V_{DS} = 5V, V_{G1} = 5V$
Output capacitance	Coss	0.7	1.1	1.5	pF	$V_{G2S} = 4V, R_G = 180k\Omega$
Reverse transfer capacitance	Crss	—	0.02	0.05	pF	$f = 1MHz$
Power gain	PG	17	22	—	dB	$V_{DS} = 5V, V_{G1} = 5V$ $V_{G2S} = 4V, R_G = 180k\Omega$
Noise figure	NF	—	1.6	2.2	dB	$f = 900MHz$

Test Circuits

- DC Biasing Circuit for Operating Characteristics Items ($I_{D(op)}$, $|y_{fs}|$, C_{iss} , C_{oss} , C_{rss} , NF, PG)

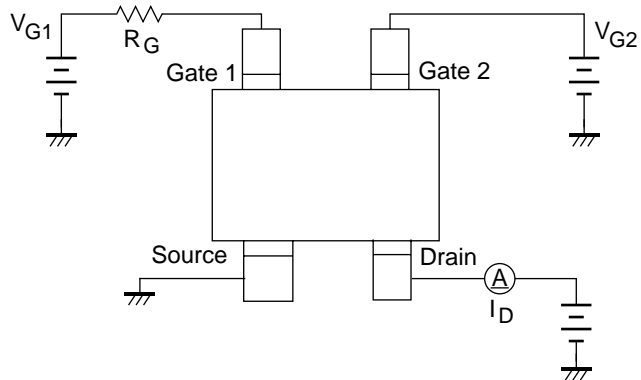

• 900 MHz Power Gain, Noise Figure Test Circuit

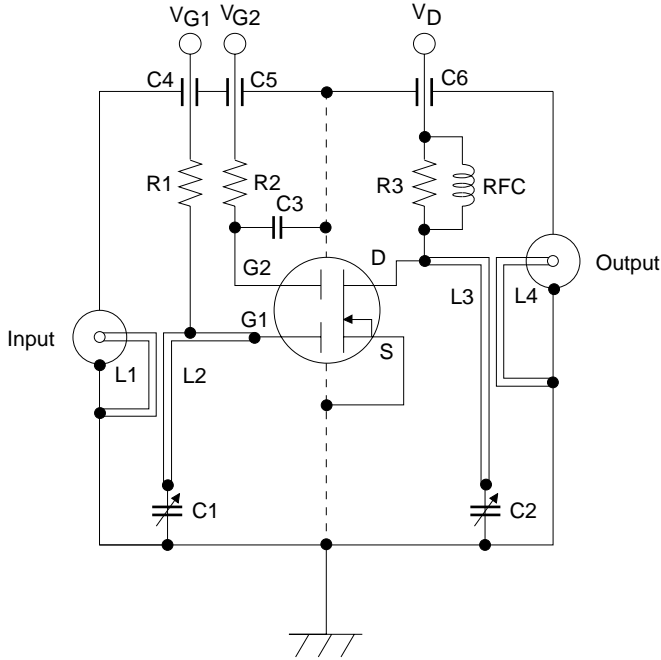

- C1, C2 : Variable Capacitor (10pF MAX)
- C3 : Disk Capacitor (1000pF)
- C4 to C6 : Air Capacitor (1000pF)
- R1 : 180 k Ω
- R2 : 47 k Ω
- R3 : 4.7 k Ω

L1:

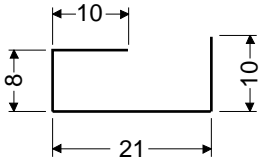

L2:

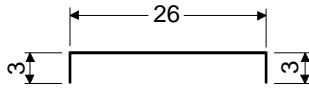

(Φ 1mm Copper wire)
Unit:mm

L3:

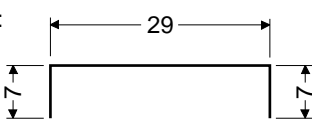

L4:

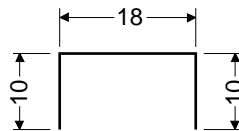

RFC : Φ 1mm Copper wire with enamel 4turns inside dia 6mm

Maximum Channel Power Dissipation Curve

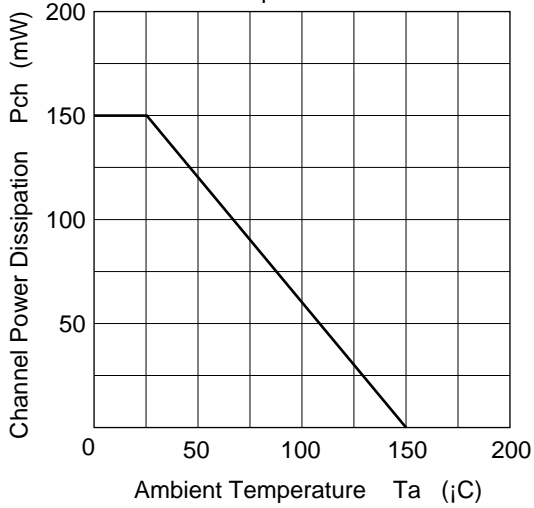

Typical Output Characteristics

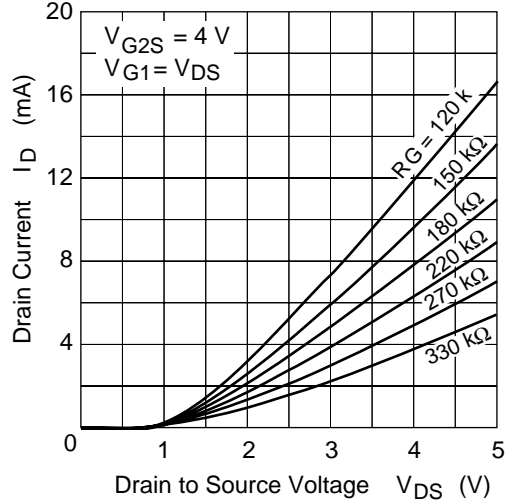

Drain Current vs. Gate1 Voltage

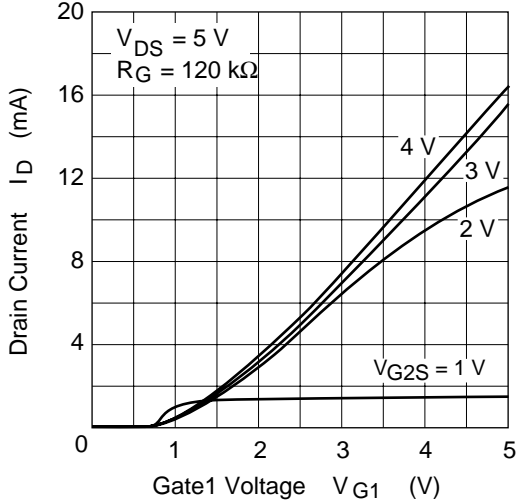

Drain Current vs. Gate1 Voltage

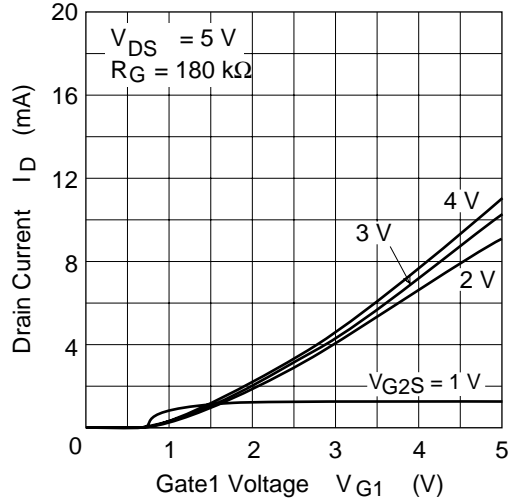

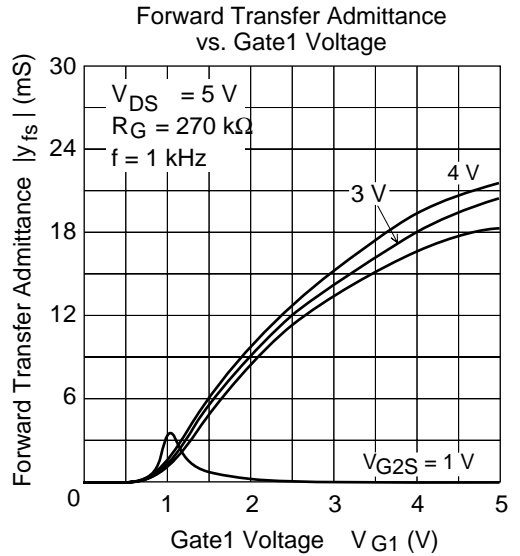
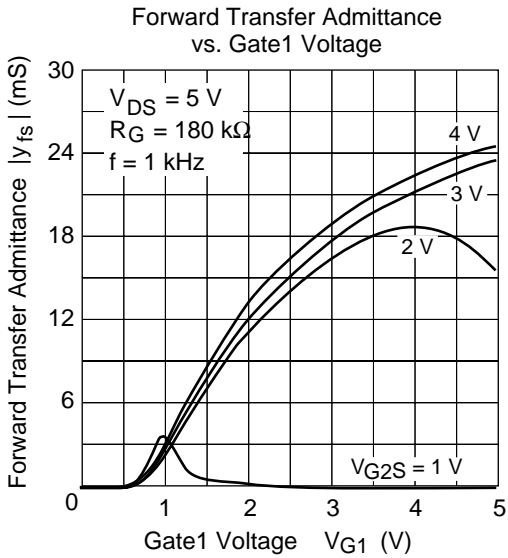
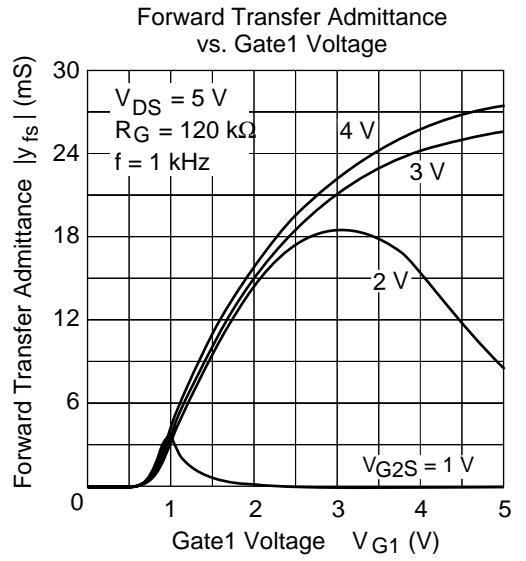
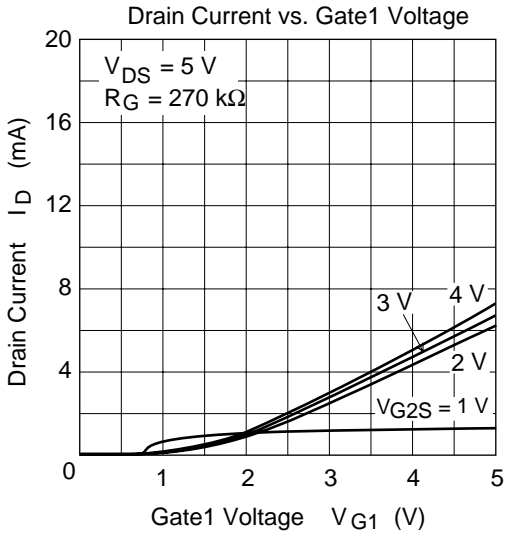

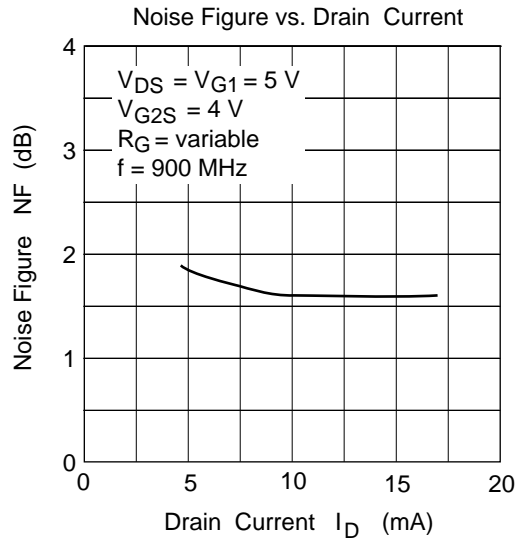
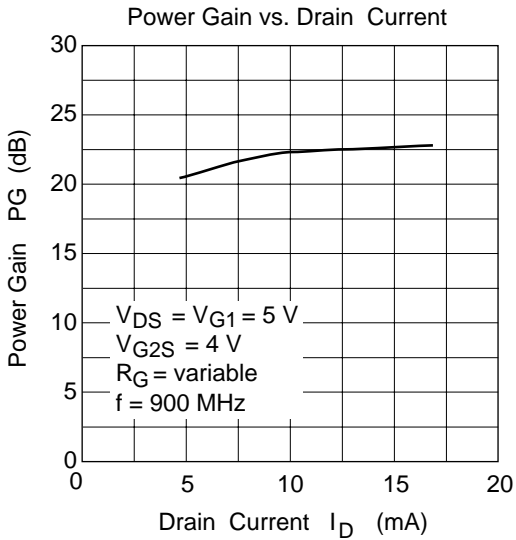
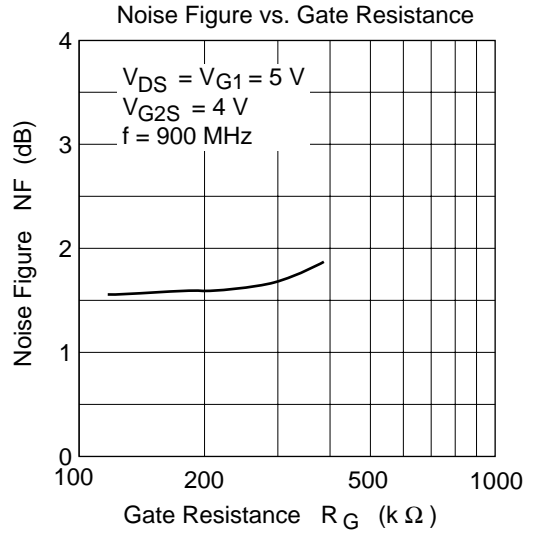
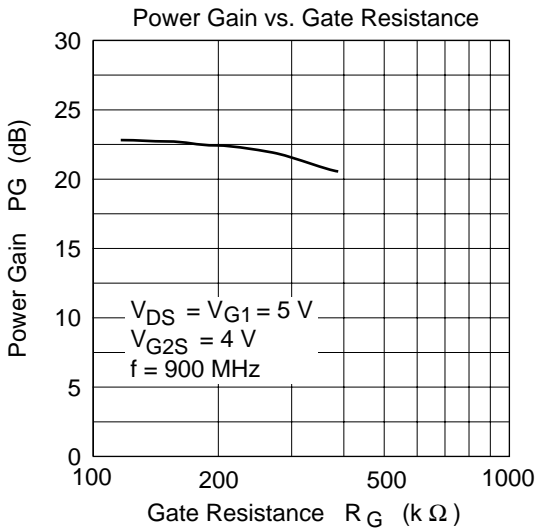

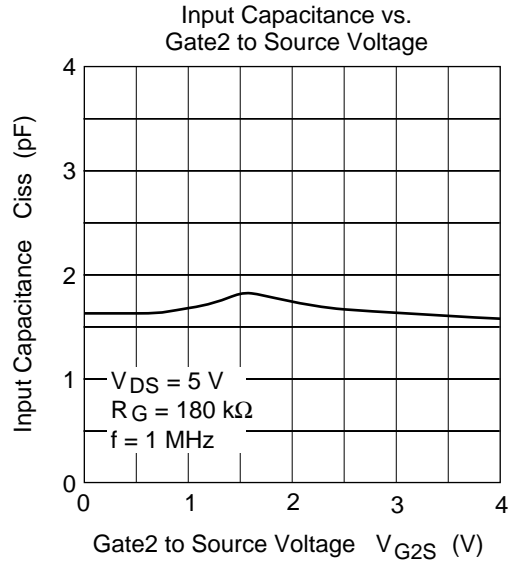
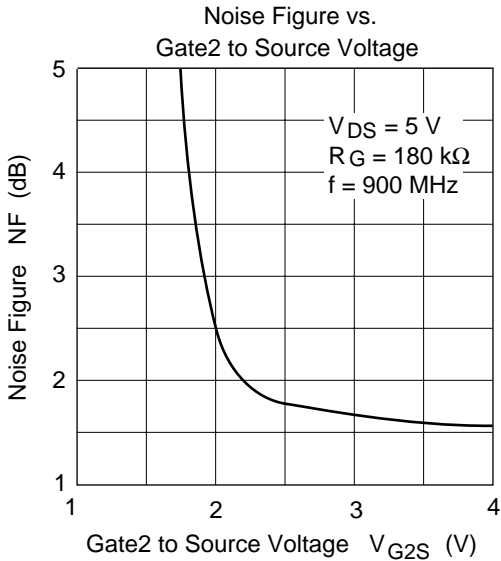
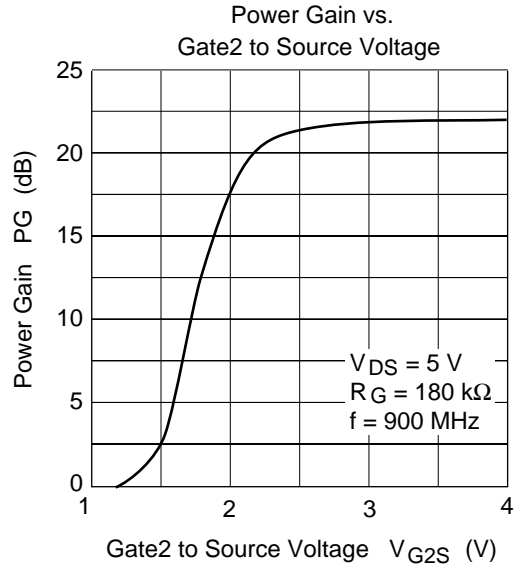
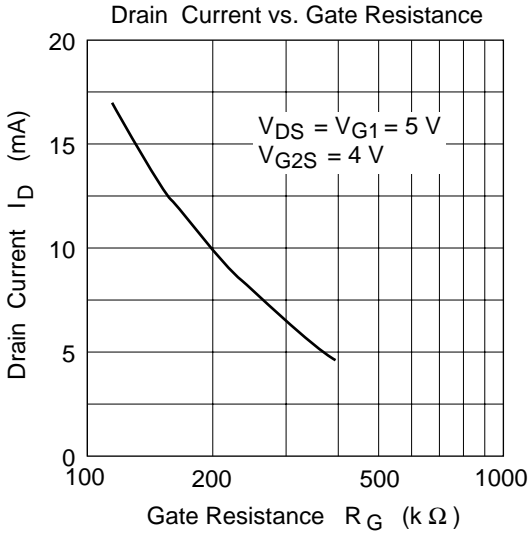

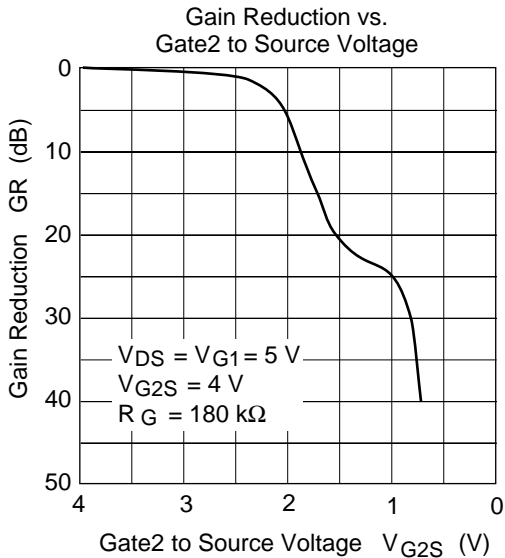

S11 Parameter vs. Frequency

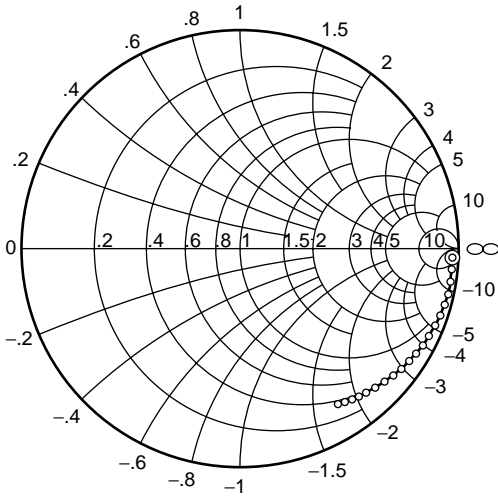

Test Condition: $V_{DS} = 5\text{ V}$, $V_{G1} = 5\text{ V}$
 $V_{G2S} = 4\text{ V}$, $R_G = 180\text{ k}\Omega$,
 $Z_o = 50\ \Omega$

50 ~ 1000 MHz (50 MHz step)



S21 Parameter vs. Frequency

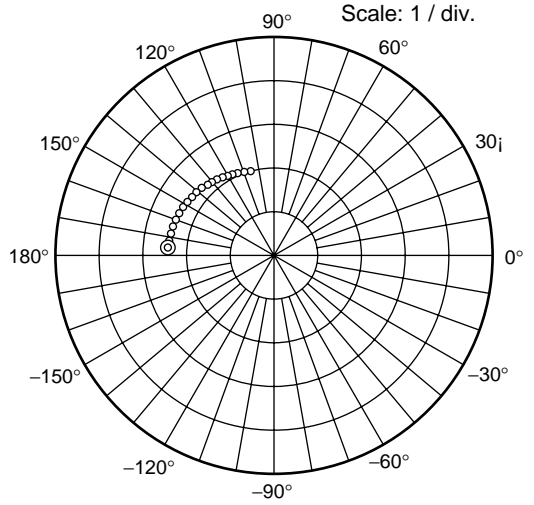

Test Condition: $V_{DS} = 5\text{ V}$, $V_{G1} = 5\text{ V}$
 $V_{G2S} = 4\text{ V}$, $R_G = 180\text{ k}\Omega$,
 $Z_o = 50\ \Omega$

50 ~ 1000 MHz (50 MHz step)



S12 Parameter vs. Frequency

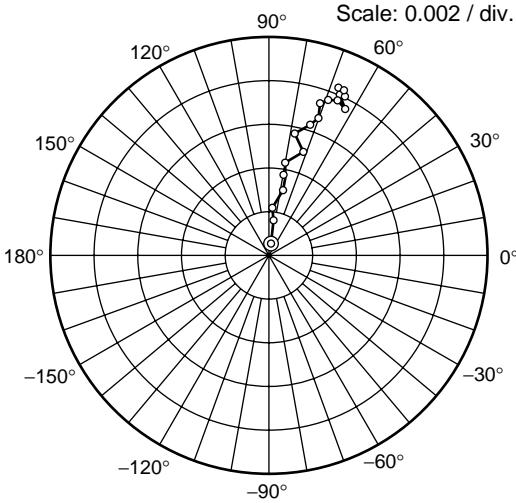

Test Condition: $V_{DS} = 5\text{ V}$, $V_{G1} = 5\text{ V}$
 $V_{G2S} = 4\text{ V}$, $R_G = 180\text{ k}\Omega$,
 $Z_o = 50\ \Omega$

50 ~ 1000 MHz (50 MHz step)



S22 Parameter vs. Frequency

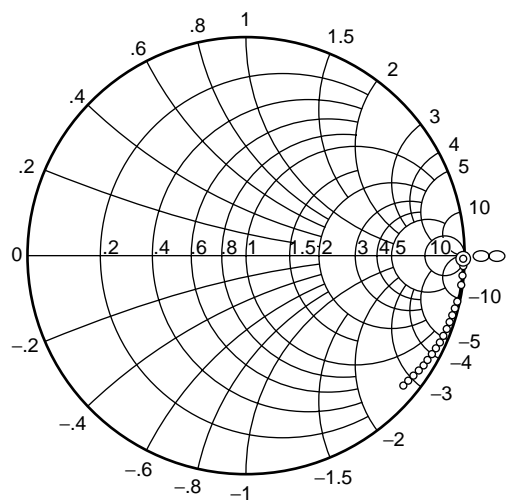

Test Condition: $V_{DS} = 5\text{ V}$, $V_{G1} = 5\text{ V}$
 $V_{G2S} = 4\text{ V}$, $R_G = 180\text{ k}\Omega$,
 $Z_o = 50\ \Omega$

50 ~ 1000 MHz (50 MHz step)



Sparameter ($V_{DS} = V_{G1} = 5 \text{ V}$, $V_{G2S} = 4 \text{ V}$, $R_G = 180 \text{ k}\Omega$, $Z_o = 50 \Omega$)

f (MHz)	S11		S21		S12		S22	
	MAG	ANG	MAG	ANG	MAG	ANG	MAG	ANG
50	0.994	-2.8	2.52	176.2	0.00072	88.6	0.995	-2.2
100	0.994	-5.7	2.51	172.4	0.00161	80.9	0.998	-4.0
150	0.991	-9.2	2.50	168.1	0.00230	86.6	0.997	-6.2
200	0.985	-12.5	2.47	164.1	0.00297	78.0	0.996	-8.2
250	0.985	-15.5	2.46	160.0	0.00374	78.9	0.994	-10.2
300	0.975	-18.7	2.43	156.4	0.00436	80.6	0.992	-12.2
350	0.969	-22.0	2.40	152.3	0.00507	70.9	0.990	-14.2
400	0.962	-24.9	2.38	148.6	0.00557	77.3	0.989	-16.3
450	0.954	-27.7	2.35	144.6	0.00625	72.4	0.987	-18.5
500	0.945	-30.8	2.31	141.0	0.00663	70.0	0.984	-20.4
550	0.935	-33.8	2.28	136.7	0.00721	70.5	0.981	-22.4
600	0.925	-36.6	2.25	133.4	0.00747	68.4	0.978	-24.3
650	0.918	-39.5	2.21	130.3	0.00761	65.6	0.975	-26.4
700	0.909	-42.5	2.18	126.1	0.00807	65.6	0.972	-28.3
750	0.898	-45.0	2.14	122.9	0.00828	67.6	0.969	-30.2
800	0.887	-47.8	2.09	119.5	0.00801	65.1	0.965	-32.2
850	0.874	-50.6	2.07	116.0	0.00815	63.6	0.961	-34.2
900	0.862	-53.0	2.03	112.7	0.00832	65.1	0.958	-36.1
950	0.855	-55.5	1.99	109.4	0.00738	61.8	0.954	-37.9
1000	0.845	-58.1	1.95	106.1	0.00802	65.8	0.951	-39.8

Package Dimintions

Unit: mm

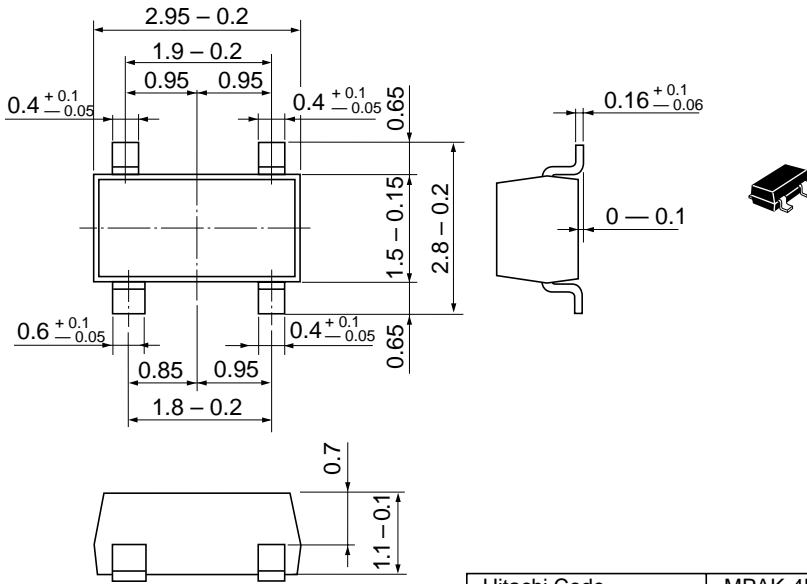

Hitachi Code	MPAK-4R
JEDEC	
EIAJ	
Mass (reference value)	0.013 g

Cautions

1. Hitachi neither warrants nor grants licenses of any rights of Hitachi's or any third party's patent, copyright, trademark, or other intellectual property rights for information contained in this document. Hitachi bears no responsibility for problems that may arise with third party's rights, including intellectual property rights, in connection with use of the information contained in this document.
2. Products and product specifications may be subject to change without notice. Confirm that you have received the latest product standards or specifications before final design, purchase or use.
3. Hitachi makes every attempt to ensure that its products are of high quality and reliability. However, contact Hitachi's sales office before using the product in an application that demands especially high quality and reliability or where its failure or malfunction may directly threaten human life or cause risk of bodily injury, such as aerospace, aeronautics, nuclear power, combustion control, transportation, traffic, safety equipment or medical equipment for life support.
4. Design your application so that the product is used within the ranges guaranteed by Hitachi particularly for maximum rating, operating supply voltage range, heat radiation characteristics, installation conditions and other characteristics. Hitachi bears no responsibility for failure or damage when used beyond the guaranteed ranges. Even within the guaranteed ranges, consider normally foreseeable failure rates or failure modes in semiconductor devices and employ systemic measures such as fail-safes, so that the equipment incorporating Hitachi product does not cause bodily injury, fire or other consequential damage due to operation of the Hitachi product.
5. This product is not designed to be radiation resistant.
6. No one is permitted to reproduce or duplicate, in any form, the whole or part of this document without written approval from Hitachi.
7. Contact Hitachi's sales office for any questions regarding this document or Hitachi semiconductor products.

HITACHI

Hitachi, Ltd.

Semiconductor & Integrated Circuits.
Nippon Bldg., 2-6-2, Ohte-machi, Chiyoda-ku, Tokyo 100-0004, Japan
Tel: Tokyo (03) 3270-2111 Fax: (03) 3270-5109

URL	North America	: http://semiconductor.hitachi.com/
	Europe	: http://www.hitachi-eu.com/hel/ecg
	Asia	: http://sicapac.hitachi-asia.com
	Japan	: http://www.hitachi.co.jp/Sicd/indx.htm

For further information write to:

Hitachi Semiconductor
(America) Inc.
179 East Tasman Drive,
San Jose, CA 95134
Tel: <1> (408) 433-1990
Fax: <1> (408) 433-0223

Hitachi Europe GmbH
Electronic Components Group
Dornacher StraÙe 3
D-85622 Feldkirchen, Munich
Germany
Tel: <49> (89) 9 9180-0
Fax: <49> (89) 9 29 30 00

Hitachi Europe Ltd.
Electronic Components Group.
Whitebrook Park
Lower Cookham Road
Maidenhead
Berkshire SL6 8YA, United Kingdom
Tel: <44> (1628) 585000
Fax: <44> (1628) 585160

Hitachi Asia Ltd.
Hitachi Tower
16 Collyer Quay #20-00,
Singapore 049318
Tel: <65>-538-6533/538-8577
Fax : <65>-538-6933/538-3877
URL : <http://www.hitachi.com.sg>

Hitachi Asia Ltd.
(Taipei Branch Office)
4/F, No. 167, Tun Hwa North Road,
Hung-Kuo Building,
Taipei (105), Taiwan
Tel: <886>-(2)-2718-3666
Fax : <886>-(2)-2718-8180
Telex : 23222 HAS-TP
URL : <http://www.hitachi.com.tw>

Hitachi Asia (Hong Kong) Ltd.
Group III (Electronic Components)
7/F., North Tower,
World Finance Centre,
Harbour City, Canton Road
Tsim Sha Tsui, Kowloon,
Hong Kong
Tel : <852>-(2)-735-9218
Fax : <852>-(2)-730-0281
URL : <http://www.hitachi.com.hk>

Copyright © Hitachi, Ltd., 2000. All rights reserved. Printed in Japan.
Colophon 2.0

HITACHI