

TOSHIBA LED LAMP GaP GREEN LIGHT EMISSION

# TLGC245P

PANEL CIRCUIT INDICATOR

- 5mm DIAMETER (T1-3/4) FLANGELESS PACKAGE
- All Plastic Mold Type Colorless Clear Lens
- Low Drive Current, High Intensity Green Light Emission.
- All Plastic Molded Lens, Provides an Excellent ON-OFF Contrast Ratio.
- Without stand-offs
- Fast Response Time, Capable of Pulse Operation.
- High Power Luminous Intensity  
Suitable for Outdoor Message Signboard.

MAXIMUM RATINGS (Ta = 25°C)

CHARACTERISTIC	SYMBOL	RATING	UNIT
Forward Current	I <sub>F</sub>	40	mA
Reverse Voltage	V <sub>R</sub>	4	V
Power Dissipation	P <sub>D</sub>	120	mW
Operating Temperature Range	T <sub>opr</sub>	-20~85	°C
Storage Temperature Range	T <sub>stg</sub>	-30~100	°C

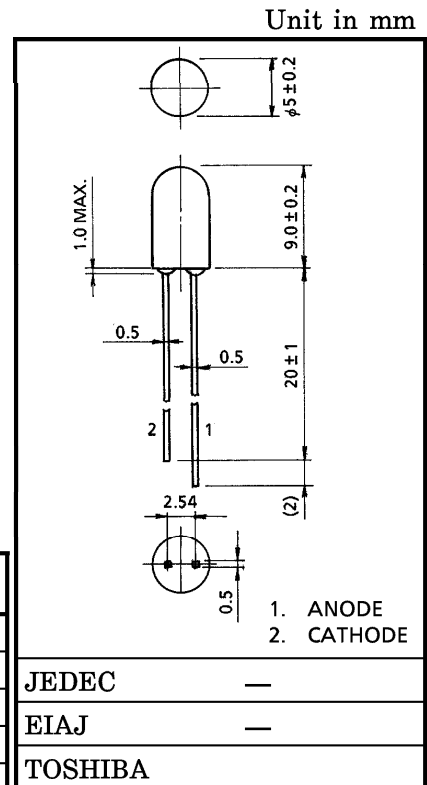

Weight : 0.31g

ELECTRO-OPTICAL CHARACTERISTICS (Ta = 25°C)

CHARACTERISTIC	SYMBOL	TEST CONDITION	MIN.	TYP.	MAX.	UNIT
Forward Voltage	V <sub>F</sub>	I <sub>F</sub> = 20mA	—	2.15	2.8	V
Reverse Current	I <sub>R</sub>	V <sub>R</sub> = 4V	—	—	5	μA
Luminous Intensity	I <sub>V</sub>	I <sub>F</sub> = 20mA	47.6	150	—	mcd
Peak Emission Wave Length	λ <sub>p</sub>	I <sub>F</sub> = 20mA	—	567	—	nm
Spectral Line Half Width	Δλ	I <sub>F</sub> = 20mA	—	25	—	nm

PRECAUTION

Please be careful of the followings

- Soldering temperature : 260°C MAX. Soldering time : 3s MAX.  
(Soldering portion of lead : up to 2mm from the body of the device)
- If the lead is formed, the lead should be formed up to 5mm from the body of the device without forming stress to the resin. Soldering should be performed after lead forming.

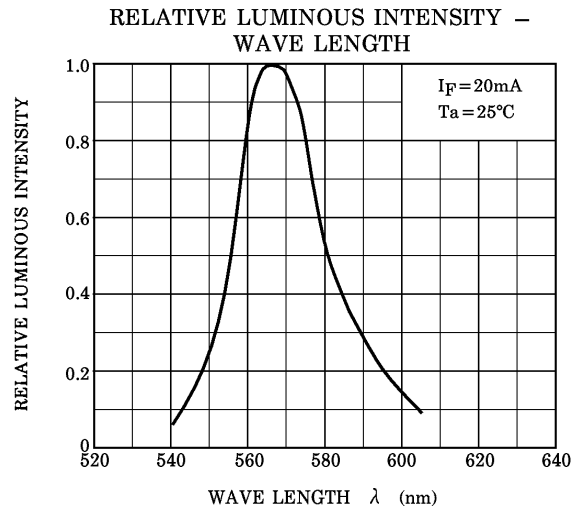
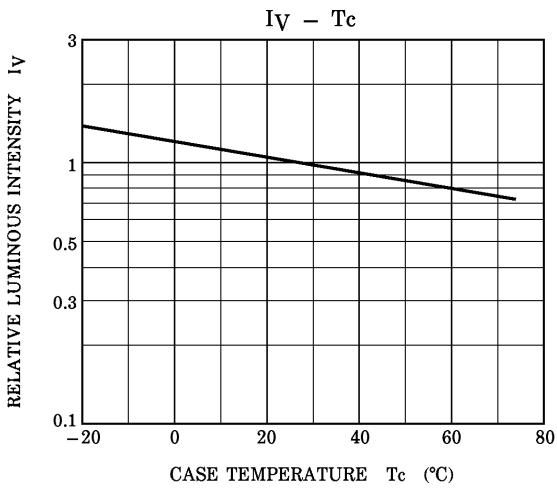
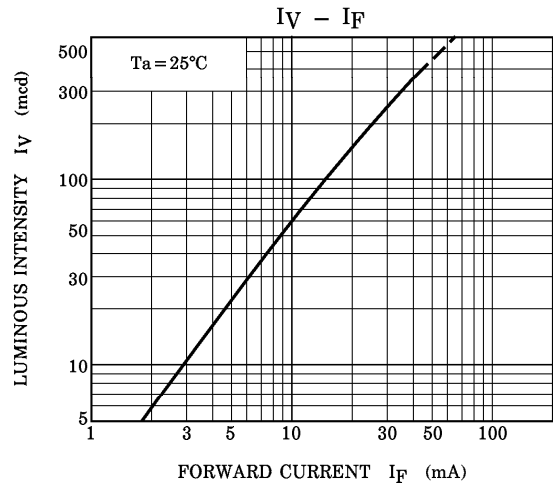
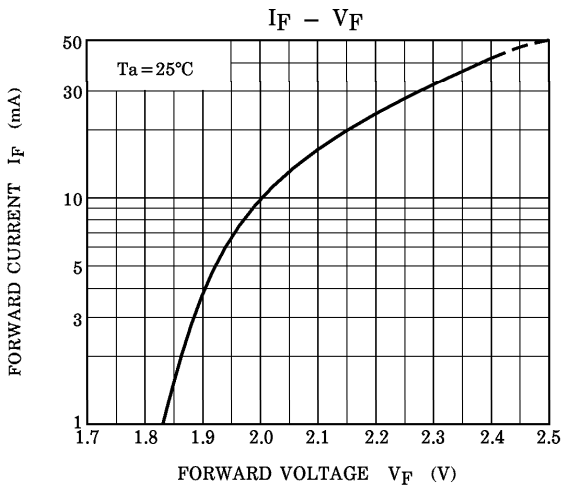

RADIATION PATTERN

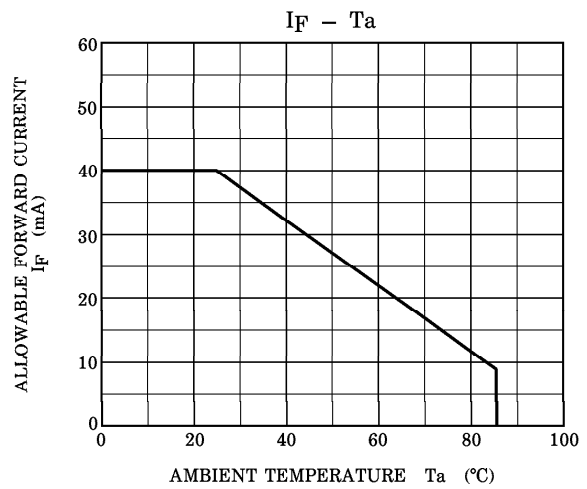
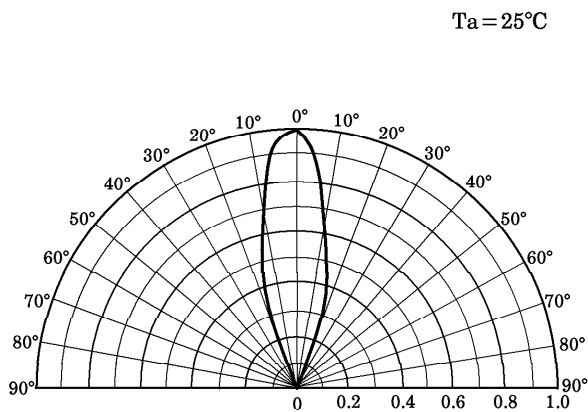

**RESTRICTIONS ON PRODUCT USE**

000707EAA

- TOSHIBA is continually working to improve the quality and reliability of its products. Nevertheless, semiconductor devices in general can malfunction or fail due to their inherent electrical sensitivity and vulnerability to physical stress. It is the responsibility of the buyer, when utilizing TOSHIBA products, to comply with the standards of safety in making a safe design for the entire system, and to avoid situations in which a malfunction or failure of such TOSHIBA products could cause loss of human life, bodily injury or damage to property. In developing your designs, please ensure that TOSHIBA products are used within specified operating ranges as set forth in the most recent TOSHIBA products specifications. Also, please keep in mind the precautions and conditions set forth in the "Handling Guide for Semiconductor Devices," or "TOSHIBA Semiconductor Reliability Handbook" etc..
- The TOSHIBA products listed in this document are intended for usage in general electronics applications (computer, personal equipment, office equipment, measuring equipment, industrial robotics, domestic appliances, etc.). These TOSHIBA products are neither intended nor warranted for usage in equipment that requires extraordinarily high quality and/or reliability or a malfunction or failure of which may cause loss of human life or bodily injury ("Unintended Usage"). Unintended Usage include atomic energy control instruments, airplane or spaceship instruments, transportation instruments, traffic signal instruments, combustion control instruments, medical instruments, all types of safety devices, etc.. Unintended Usage of TOSHIBA products listed in this document shall be made at the customer's own risk.
- The information contained herein is presented only as a guide for the applications of our products. No responsibility is assumed by TOSHIBA CORPORATION for any infringements of intellectual property or other rights of the third parties which may result from its use. No license is granted by implication or otherwise under any intellectual property or other rights of TOSHIBA CORPORATION or others.
- The information contained herein is subject to change without notice.