

SFH618-2X, SFH618-3X, SFH618-4X,
SFH618-2, SFH618-3, SFH618-4



**LOW INPUT CURRENT
PHOTOTRANSISTOR
OPTICALLY COUPLED ISOLATORS**

APPROVALS

- UL recognised, File No. E91231
- 'X' SPECIFICATION APPROVALS**
- Certified to EN60950 by the following Test Bodies :-
Nemko - Certificate No. P96102022
Fimko - Registration No. 192313-01..25
Semko - Reference No. 9639052 01
Demko - Reference No. 305969

- VDE 0884 approval pending

DESCRIPTION

The SFH618 series of optically coupled isolators consist of infrared light emitting diodes and NPN silicon photo transistors in space efficient dual in line plastic packages.

FEATURES

- Options :-
10mm lead spread - add G after part no.
Surface mount - add SM after part no.
Tape&reel - add SMT&R after part no.
- Low input current 0.5mA I_F
- High Current Transfer Ratios (63-320% at 1mA, 32% min at 0.5mA)
- High Isolation Voltage (5.3kV_{RMS}, 7.5kV_{PK})
- High BV_{CEO} (55V min)
- All electrical parameters 100% tested
- Custom electrical selections available

APPLICATIONS

- Computer terminals
- Industrial systems controllers
- Measuring instruments
- Signal transmission between systems of different potentials and impedances

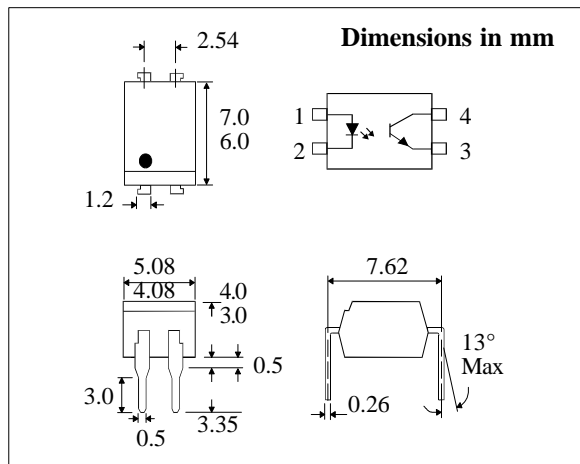

**ABSOLUTE MAXIMUM RATINGS
(25°C unless otherwise specified)**

Storage Temperature _____ -55°C to + 125°C
Operating Temperature _____ -55°C to + 100°C
Lead Soldering Temperature
(1/16 inch (1.6mm) from case for 10 secs) 260°C

INPUT DIODE

Forward Current _____ 50mA
Reverse Voltage _____ 6V
Power Dissipation _____ 70mW

OUTPUT TRANSISTOR

Collector-emitter Voltage BV_{CEO} _____ 55V
Emitter-collector Voltage BV_{ECO} _____ 6V
Power Dissipation _____ 150mW

POWER DISSIPATION

Total Power Dissipation _____ 200mW
(derate linearly 2.67mW/°C above 25°C)

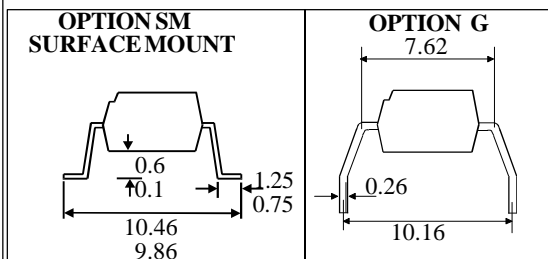

ISOCOM COMPONENTS LTD
Unit 25B, Park View Road West,
Park View Industrial Estate, Brenda Road
Hartlepool, Cleveland, TS25 1YD
Tel: (01429) 863609 Fax :(01429) 863581

ISOCOM INC
1024 S. Greenville Ave, Suite 240,
Allen, TX 75002 USA
Tel: (214) 495-0755 Fax: (214) 495-0901
e-mail info@isocom.com
http://www.isocom.com

ELECTRICAL CHARACTERISTICS ($T_A = 25^\circ\text{C}$ Unless otherwise noted)

PARAMETER		MIN	TYP	MAX	UNITS	TEST CONDITION	
Input	Forward Voltage (V_F)			1.5	V	$I_F = 5\text{mA}$ $I_R = 10\mu\text{A}$ $V_R = 6\text{V}$	
	Reverse Voltage (V_R)	6			V		
	Reverse Current (I_R)			10	μA		
Output	Collector-emitter Breakdown (BV_{CEO}) (Note 2)	55			V	$I_C = 1\text{mA}$ $I_E = 100\mu\text{A}$ $V_{CE} = 10\text{V}$	
	Emitter-collector Breakdown (BV_{ECO})	6			V		
	Collector-emitter Dark Current (I_{CEO})			200	nA		
Coupled	Current Transfer Ratio (CTR) (Note 2)					$1\text{mA } I_F, 0.5\text{V } V_{CE}$ $0.5\text{mA } I_F, 1.5\text{V } V_{CE}$ $1\text{mA } I_F, 0.5\text{V } V_{CE}$ $0.5\text{mA } I_F, 1.5\text{V } V_{CE}$ $1\text{mA } I_F, 0.5\text{V } V_{CE}$ $0.5\text{mA } I_F, 1.5\text{V } V_{CE}$ $1\text{mA } I_F, 0.32\text{mA } I_C$ $1\text{mA } I_F, 0.5\text{mA } I_C$ $1\text{mA } I_F, 0.8\text{mA } I_C$ See note 1 See note 1 $V_{IO} = 500\text{V}$ (note 1)	
	SFH618-2	63		125	%		
	SFH618-2	32			%		
	SFH618-3	100		200	%		
	SFH618-3	50			%		
	SFH618-4	160		320	%		
	SFH618-4	80			%		
	Collector-emitter Saturation Voltage V_{CESAT}						
	SFH618-2			0.4	V		
	SFH618-3			0.4	V		
SFH618-4			0.4	V			
Input to Output Isolation Voltage V_{ISO}	5300				V_{RMS}		
	7500				V_{PK}		
Input-output Isolation Resistance R_{ISO}	5×10^{10}				Ω		

- Note 1 Measured with input leads shorted together and output leads shorted together.
 Note 2 Special Selections are available on request. Please consult the factory.

SWITCHING CHARACTERISTICS

$I_C = 2\text{mA}, V_{CC} = 5\text{V}, R_L = 100\Omega, T_A = 25^\circ\text{C}$ (Fig 1)

			UNITS
Turn-on Time	t_{on}	6.0	μs
Rise Time	t_r	3.5	μs
Turn-off Time	t_{off}	5.5	μs
Fall Time	t_f	5.0	μs

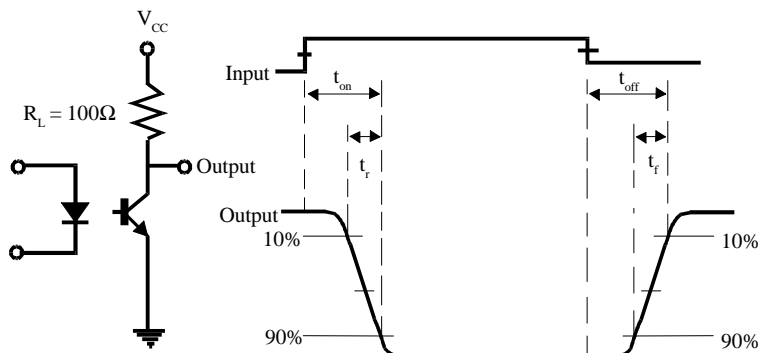
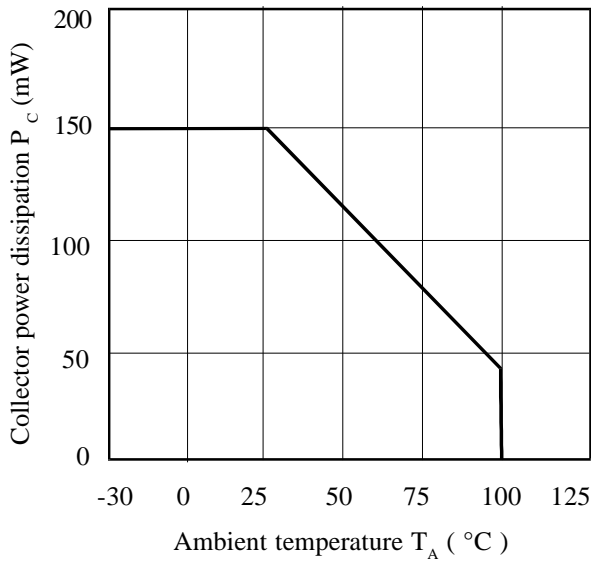
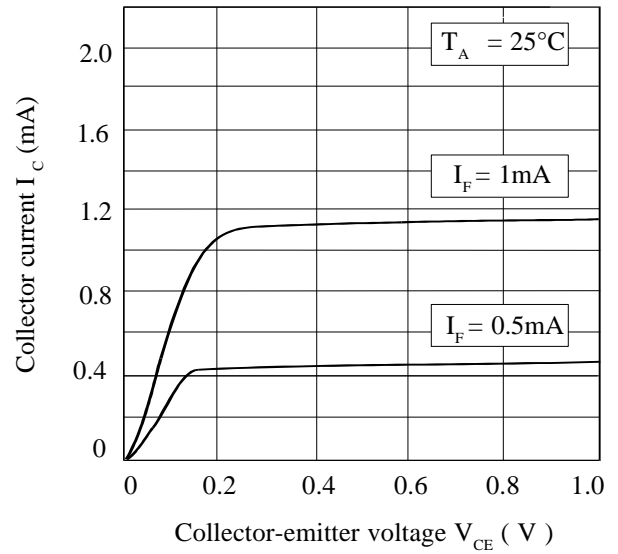

FIG 1

Collector Power Dissipation vs. Ambient Temperature



Collector Current vs. Low Collector-emitter Voltage (normalized to SFH618-2 & SFH618-3)



Forward Current vs. Ambient Temperature

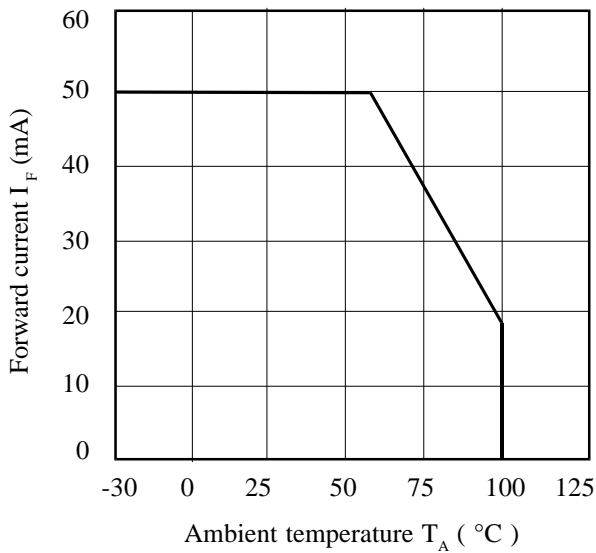

Relative Current Transfer Ratio vs. Ambient Temperature

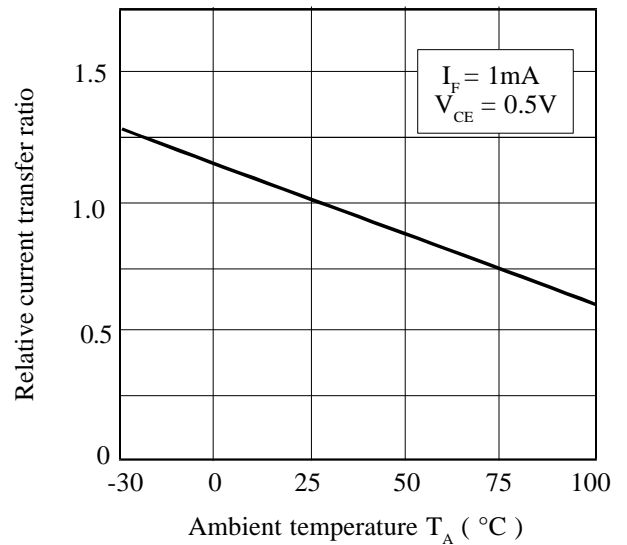

Collector-emitter Saturation Voltage vs. Ambient Temperature

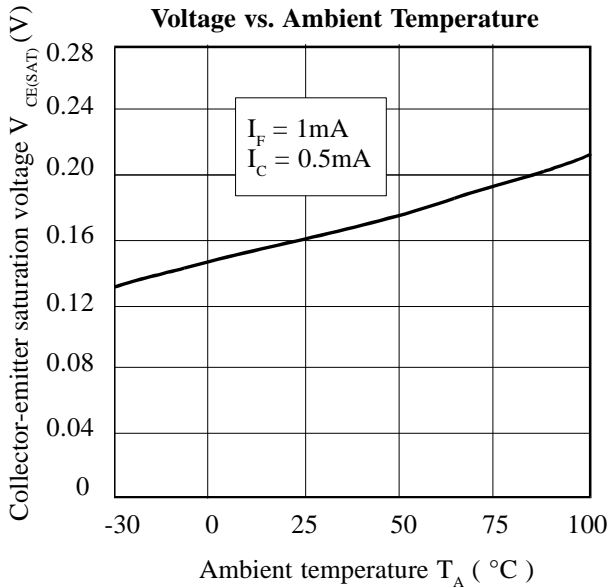

Current Transfer Ratio vs. Forward Current (normalized to SFH618-2 & SFH618-3)

