4AC14

Silicon NPN Triple Diffused

HITACHI

Application

Low frequency power amplifier

Outline

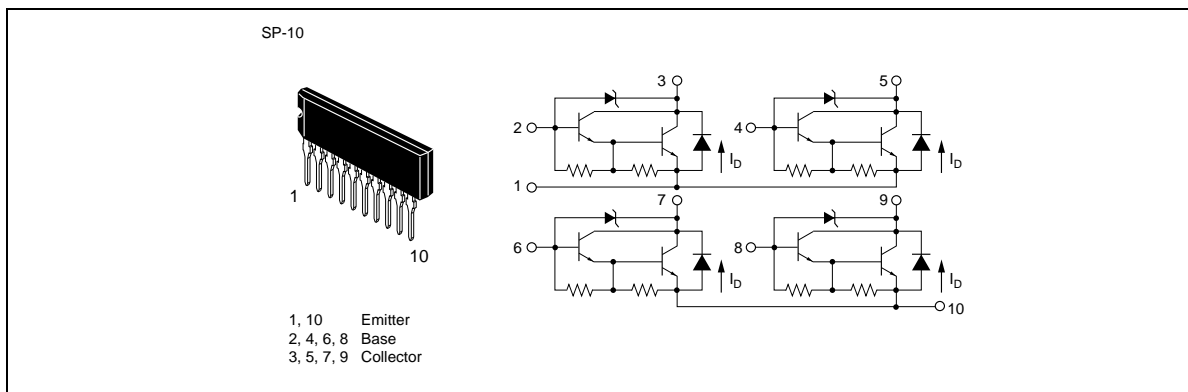

4AC14

Absolute Maximum Ratings (for each device, Ta = 25°C)

Item	Symbol	Ratings	Unit
Collector to base voltage	V_{CBO}	150	V
Collector to emitter voltage	V_{CEO}	150	V
Emitter to base voltage	V_{EBO}	7	V
Collector current	I_C	5	A
Collector peak current	$I_{C(peak)}$	10	A
Diode current	I_D	5	A
Collector power dissipation	P_C^{*1}	4	W
	$P_C^{*1} (T_C = 25^\circ\text{C})$	28	
Junction temperature	Tj	150	°C
Storage temperature	Tstg	-55 to +150	°C

Note: 1. 4 devices operation.

Electrical Characteristics (for each device, Ta = 25°C)

Item	Symbol	Min	Typ	Max	Unit	Test conditions
Collector to emitter breakdown voltage	$V_{(BR)CBO}$	150	—	—	V	$I_C = 0.1 \text{ mA}, I_E = 0$
Collector to emitter sustain voltage	$V_{CEO(SUS)}$	150	—	—	V	$I_C = 0.2 \text{ A}, L = 20 \text{ mHz}, R_{BE} = \infty$
Emitter to base breakdown voltage	$V_{(BR)EBO}$	7	—	—	V	$I_E = 50 \text{ mA}, I_C = 0$
Collector cutoff current	I_{CBO}	—	—	10	μA	$V_{CB} = 120 \text{ V}, I_E = 0$
	I_{CEO}	—	—	10		$V_{CE} = 120 \text{ V}, R_{BE} = \infty$
DC current transfer ratio	h_{FE}	1000	—	20000		$V_{CE} = 3 \text{ V}, I_C = 3 \text{ A}^{*1}$
Collector to emitter saturation voltage	$V_{CE(sat)}$	—	—	1.5	V	$I_C = 3 \text{ A}, I_B = 6 \text{ mA}^{*1}$
Base to emitter saturation voltage	$V_{BE(sat)}$	—	—	2.0	V	$I_C = 3 \text{ A}, I_B = 6 \text{ mA}^{*1}$
C to E diode forward current	V_D	—	—	3.5	V	$I_D = 5 \text{ A}$

Note: 1. Pulse test.

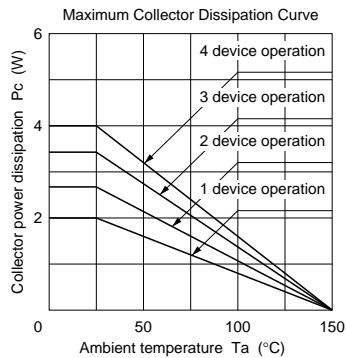

Note: Collector power dissipation of each devices is identical.

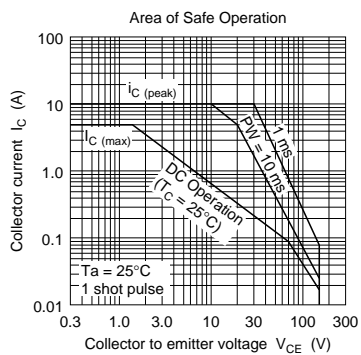
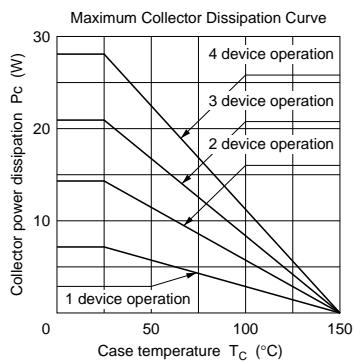

4AC14

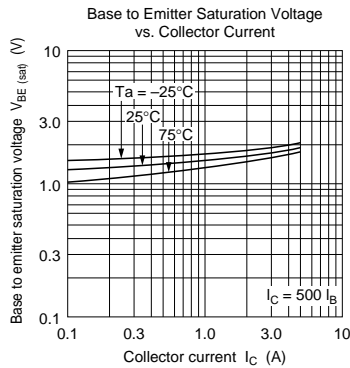
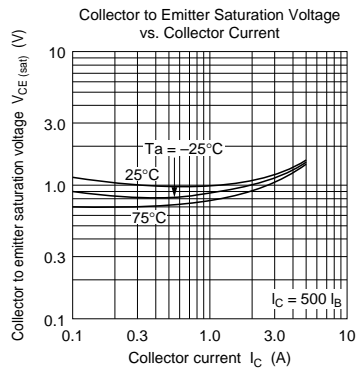
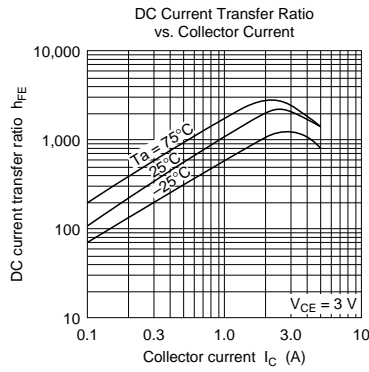
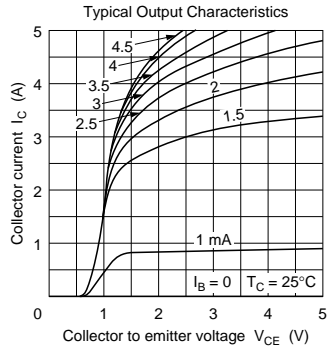

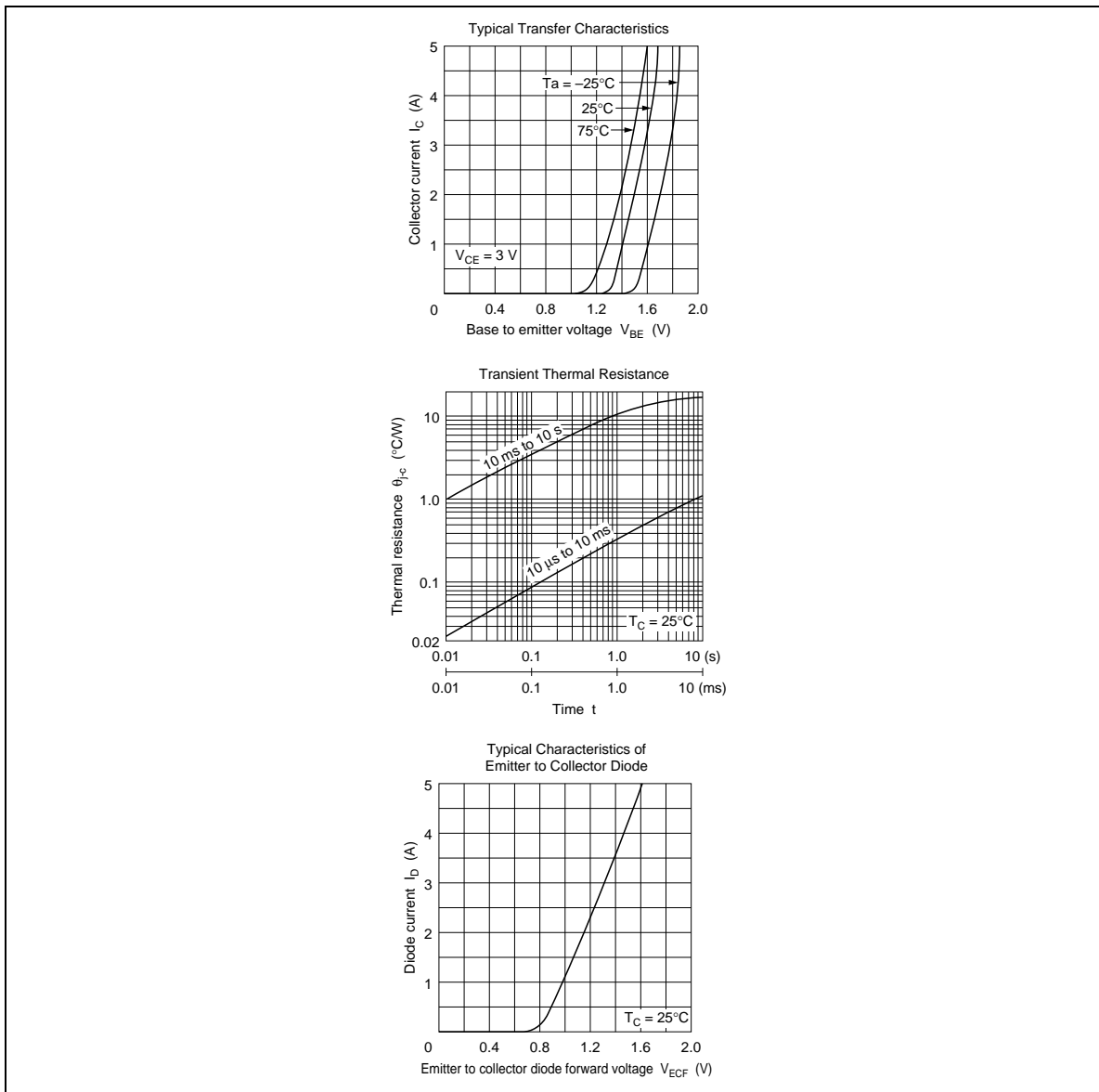

4AC14

Unit: mm

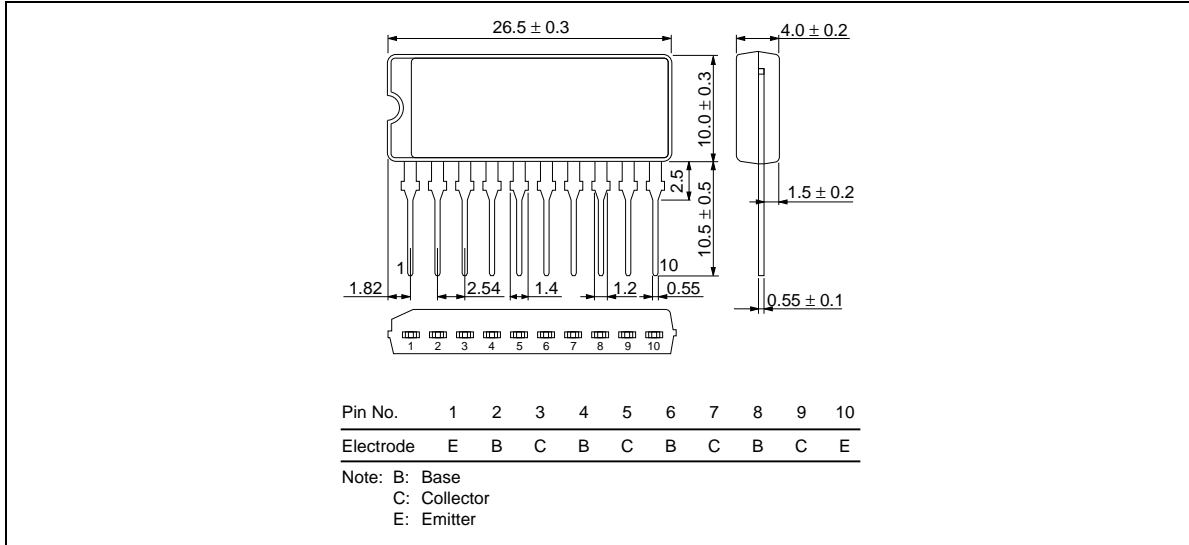

When using this document, keep the following in mind:

1. This document may, wholly or partially, be subject to change without notice.
2. All rights are reserved: No one is permitted to reproduce or duplicate, in any form, the whole or part of this document without Hitachi's permission.
3. Hitachi will not be held responsible for any damage to the user that may result from accidents or any other reasons during operation of the user's unit according to this document.
4. Circuitry and other examples described herein are meant merely to indicate the characteristics and performance of Hitachi's semiconductor products. Hitachi assumes no responsibility for any intellectual property claims or other problems that may result from applications based on the examples described herein.
5. No license is granted by implication or otherwise under any patents or other rights of any third party or Hitachi, Ltd.
6. **MEDICAL APPLICATIONS:** Hitachi's products are not authorized for use in **MEDICAL APPLICATIONS** without the written consent of the appropriate officer of Hitachi's sales company. Such use includes, but is not limited to, use in life support systems. Buyers of Hitachi's products are requested to notify the relevant Hitachi sales offices when planning to use the products in **MEDICAL APPLICATIONS**.

HITACHI

Hitachi, Ltd.
 Semiconductor & IC Div.
 Nippon Bldg., 2-6-2, Ohte-machi, Chiyoda-ku, Tokyo 100, Japan
 Tel: Tokyo (03) 3270-2111
 Fax: (03) 3270-5109

For further information write to:

Hitachi America, Ltd.
 Semiconductor & IC Div.
 2000 Sierra Point Parkway
 Brisbane, CA. 94005-1835
 U S A
 Tel: 415-589-8300
 Fax: 415-583-4207

Hitachi Europe GmbH
 Electronic Components Group
 Continental Europe
 Dornacher Straße 3
 D-85622 Feldkirchen
 München
 Tel: 089-9 91 80-0
 Fax: 089-9 29 30 00

Hitachi Europe Ltd.
 Electronic Components Div.
 Northern Europe Headquarters
 Whitebrook Park
 Lower Cookham Road
 Maidenhead
 Berkshire SL6 8YA
 United Kingdom
 Tel: 0628-585000
 Fax: 0628-778322

Hitachi Asia Pte. Ltd.
 16 Collyer Quay #20-00
 Hitachi Tower
 Singapore 0104
 Tel: 535-2100
 Fax: 535-1533

Hitachi Asia (Hong Kong) Ltd.
 Unit 706, North Tower,
 World Finance Centre,
 Harbour City, Canton Road
 Tsim Sha Tsui, Kowloon
 Hong Kong
 Tel: 27359218
 Fax: 27306071