

AVX
A KYOCERA GROUP COMPANY



AVX
Medium Power Film Capacitors
For Power Applications

MEDIUM POWER FILM CAPACITORS

DC FILTERING

FFB	4
FFV3	10
FFG	13
FFVE/FFVI.....	16
FFLI	19
FFLB	20
FFLC	22
FSM.....	25

PROTECTION

FSB	27
FSV	31
FPX	33
FPG	37

DISCHARGE

FD	41
----------	----

TUNING

FAV	44
FAI	46

APPLICATION NOTES	55
-------------------------	----

SPECIFIC PRODUCT REQUEST.....	61
-------------------------------	----

DC FILTERING

PROTECTION

DISCHARGE

TUNING

APP NOTES

In 1979, TPC (formerly LCC, then THOMSON-CSF PASSIVE COMPONENTS) developed **CONTROLLED SELF-HEALING technology** for medium power capacitors.

These capacitors made great advances over previous technologies by combining the benefits of Controlled Self-Healing process with superior energy densities, making it one of the most compact capacitors on the market for 1/2 CV².

TPC produces both dry-wound and impregnated capacitors for medium voltage filtering, covering the whole spectrum from 75Vdc to 3kVdc.

With CONTROLLED SELF-HEALING, the capacitance is divided into several million elementary capacitor elements protected by “fuse gates”. Weak points of the dielectric are insulated and the capacitor continues functioning normally without any short circuit or explosion.

The capacitor acts like a battery. It “consumes” a certain amount of the capacitance through the gradual breakdown of the individual capacitance cells. Over the operating life of the capacitor, the capacitance gradually decreases. At the end of the capacitor’s life, the nominal capacitance will decrease down to either 2%, 5% or can be determined per customer requirements.

NOTICE: Specifications are subject to change without notice. Contact your nearest AVX Sales Office for the latest specifications. All statements, information and data given herein are believed to be accurate and reliable, but are presented without guarantee, warranty, or responsibility of any kind, expressed or implied. Statements or suggestions concerning possible use of our products are made without representation or warranty that any such use is free of patent infringement and are not recommendations to infringe any patent. The user should not assume that all safety measures are indicated or that other measures may not be required. Specifications are typical and may not apply to all applications.

General Description

DC FILTERING

The series uses a dry-wound (non-oil-filled) segmented metallized polypropylene or polyester dielectric, which features the controlled self-healing process, specially treated to have a very high dielectric strength in operating conditions up to 85°C, and up to 105°C for the FFB series.

For more information on how segmented metallized films and controlled self-healing works see a complete presentation.

AN ALTERNATIVE TO ELECTROLYTICS

FF series capacitors can be a very interesting alternative to electrolytic capacitors, because they can withstand much higher levels of surge voltage, very high rms currents and offer longer lifetimes (see section on lifetime as well as determination tables and application notes).

APPLICATIONS

The FF series capacitors are specifically designed for DC filtering and low reactive power. Main applications are: power supplies, motors, drives, electric utilities, induction heating, people movers, tramways, metro systems, unit supported power supplies, etc.

STANDARDS

- IEC 61071-1, IEC 61071-2: Power electronic capacitors
- IEC 60068-1: Environmental testing
- IEC 60077: Rules for electric traction equipment
- UL 94: Fire requirements
- NF F 16-101: Fire and smoke requirements
- NF F 16-102: Fire and smoke requirements
- IEC 60384-2: Fixed metallized polyester capacitors
- IEC 61881: Railway applications, rolling stock equipment, capacitors for power electronics

CAPACITANCE FOR POLYPROPYLENE DIELECTRIC

Polypropylene has a constant dielectric constant, irrespective of frequency up to 1 MHz: $\epsilon_r = 2.2$

POLYPROPYLENE DIELECTRIC CAPACITANCE vs TEMPERATURE

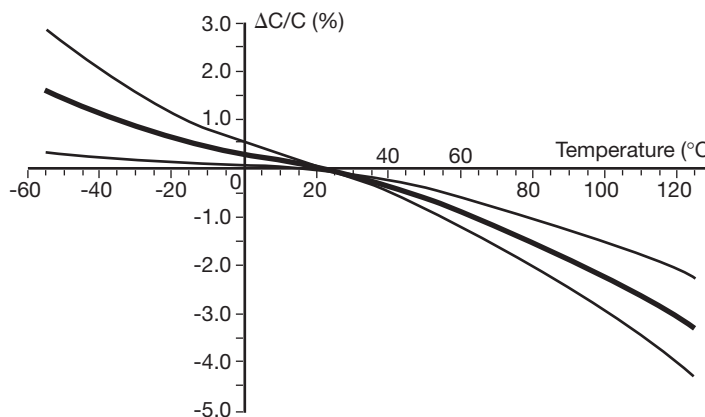

TANGENT OF LOSS ANGLE (TAN δ_0) FOR POLYPROPYLENE DIELECTRIC

Polypropylene has a constant dielectric loss factor of 2×10^{-4} irrespective of temperature and frequency (up to 1 MHz).

General Description

CAPACITANCE FOR POLYESTER DIELECTRIC

Capacitance of polyester capacitors is a function of temperature and frequency (see the curves).

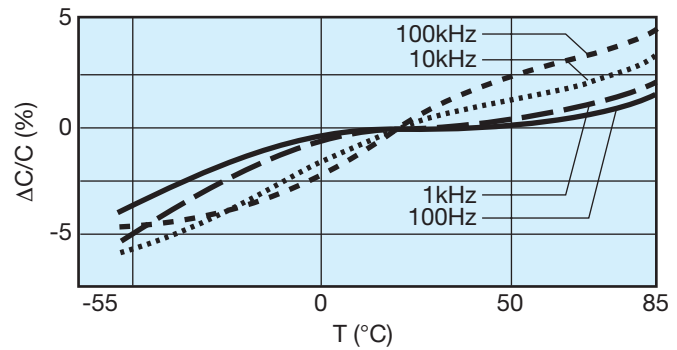
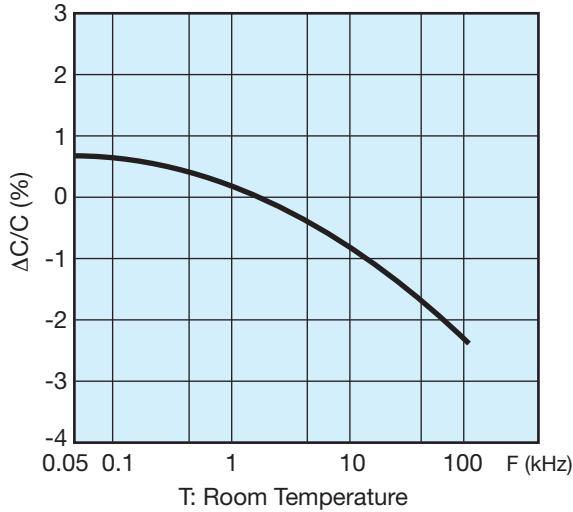

TANGENT OF LOSS ANGLE ($TAN\delta_0$) FOR POLYESTER DIELECTRIC

Dielectric loss factor of polyester is a function of temperature and frequency (see the curves).

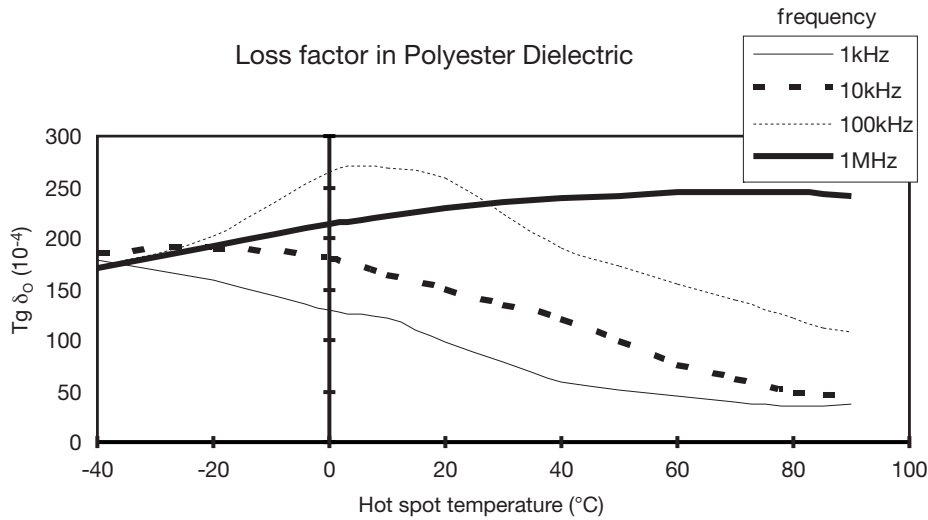

HOT SPOT CALCULATION

Calculate the maximum operating (hot spot) temperature in the following manner:

The loss factor of the capacitor is made up of the sum of two components. The first represents electrical losses (see the curve polyester losses) and the second represents Joule effect in the connections and foil. For detail formulas refer to industrial products.

Medium Power Film Capacitors



FFB

DC FILTERING

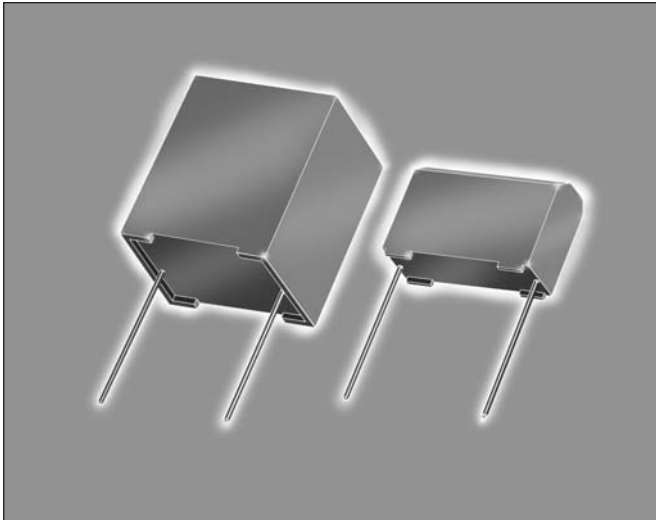

The FFB series uses a non-impregnated metallized polypropylene or polyester dielectric with the controlled self-healing process, specially treated to have a very high dielectric strength in operating conditions up to 105°C.

The FFB has been designed for printed circuit board mounting. Furthermore, their performances allow to be a very interesting alternative to electrolytic technology because they can withstand much higher levels of surge voltage.

APPLICATIONS

The FFB capacitor is particularly designed for DC filtering, low reactive power.

ELECTRICAL CHARACTERISTICS

Climatic category 55/105/56 (IEC 60068)

Test voltage between terminals @ 25°C
 $1.5 \times V_{n,dc}$

STANDARDS

- IEC 61071-1, IEC 61071-2: Power electronic capacitors
- IEC 60384-16: Fixed metallized polypropylene film dielectric DC capacitors
- IEC 60384-16-1: Fixed metallized polypropylene film dielectric DC capacitors Assessment level E
- IEC 60384-17: Fixed metallized polypropylene film dielectric AC and pulse capacitors
- IEC 60384-17-1: Fixed metallized polypropylene film dielectric AC and pulse capacitors Assessment level E
- IEC 60384-2: Fixed metallized polyester capacitors

WORKING TEMPERATURE

(according to the power to be dissipated) -55°C to +105°C

LIFETIME EXPECTANCY

One unique feature of this technology (as opposed to electrolytics) is how the capacitor reacts at the end of its lifetime. Whereas, with an electrolytic, there is a strong risk of explosion of the case. However, with our line of film capacitors, the capacitor will simply experience at the end of life a loss of capacitance of about 2%, with no risk of explosion.

Please note that this is theoretical, however, as the capacitor continues to be functional even after this 2% decrease.

HOT SPOT TEMPERATURE CALCULATION

You can calculate the maximum operating (hot spot) temperature of this capacitor in the following manner:

The loss factor of the capacitor is made up of the sum of two components. The first represents electrical losses in the dielectric and the second component represents Joule effect in the connection and foils ($R_s \cdot C \cdot 2 \pi f$).

For all applications, the temperature in the hot spot capacitor must be lower than 105°C.

$$\theta_{\text{hot spot}} = \theta_{\text{ambient}} + [\text{tg} \delta_0 \cdot Q + R_s \cdot (I_{\text{rms}})^2] \cdot R_{\text{th}}$$

With:

Q : Reactive power in Var

R_s in Ohm

I_{rms} in Ampere

R_{th} : Rth ambient / hot spot in °C/W

$\text{tg} \delta_0 \cdot (10^{-4})$ is the tangent of loss angle (see $\tan \delta_0$ page 3)

PACKAGING

Self-extinguishing plastic case (V0 = in accordance with UL 94) filled thermosetting resin.

Self-extinguishing thermosetting resin (V0 = in accordance with UL 94; I3F2 = in accordance with NF F 16-101).

Medium Power Film Capacitors



FFB

GENERAL DESCRIPTION

DC FILTERING

BOX KIND: P0; 18; 19; 26; R68

2 TERMINALS SOLUTION

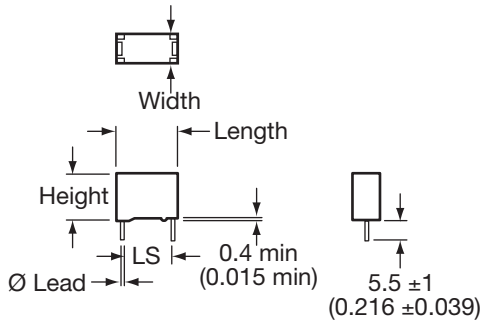

General Tolerance: $\pm 0.5\text{mm}$ (0.020)

BOX KIND: R68

4 TERMINALS SOLUTION

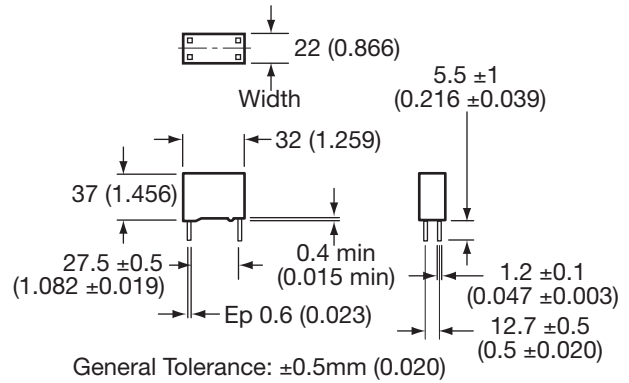

General Tolerance: $\pm 0.5\text{mm}$ (0.020)

DIMENSIONS: millimeters (inches)

Box Kind	Length mm ± 0.40 (inches)	Width mm ± 0.40 (inches)	Height mm ± 0.30 (inches)	Dimensions lead mm (inches)	LS mm ± 0.40 (inches)
P0	31.1 (1.230)	13.0 (0.051)	22.4 (0.880)	$\varnothing 0.80$ (0.031)	27.5 (1.083)
18	31.1 (1.230)	14.6 (0.580)	25.7 (1.010)	$\varnothing 0.80$ (0.031)	27.5 (1.083)
19	31.1 (1.230)	17.3 (0.068)	29.8 (1.170)	$\varnothing 0.80$ (0.031)	27.5 (1.083)
26	31.1 (1.230)	20.8 (0.820)	31.3 (1.230)	$\varnothing 1.00$ (0.039)	27.5 (1.083)
R68 2 Terminals Solution	32.0 (1.260)	22.0 (0.870)	37.0 (1.460)	$\varnothing 1.00$ (0.039)	27.5 (1.083)
R68 4 Terminals Solution	32.0 (1.260)	22.0 (0.870)	37.0 (1.460)	1.20 x 0.60 (0.047 x 0.023)	27.5 (1.083)

DC FILTERING FOR LOW VOLTAGE

ELECTRICAL CHARACTERISTICS

Capacitance range C_n	6.2 μ F to 110 μ F
Tolerance on C_n	$\pm 10\%$
Rated DC voltage $V_{n,dc}$	75 to 400 V
Dielectric	polyester

HOT SPOT CALCULATION

$$\theta_{\text{hot spot}} = \theta_{\text{ambient}} + (P_d + P_t) \times R_{th}$$

with P_d (Dielectric losses) = $Q \times \text{tg}\delta_0$
 $Q \times \text{tg}\delta_0 \Rightarrow [\frac{1}{2} \times C_n \times (V_{\text{peak to peak}})^2 \times f] \times \text{tg}\delta_0$
(see $\text{tg}\delta_0$ for polyester dielectric page 3)

$$P_t \text{ (Thermal losses)} = R_s \times (I_{rms})^2$$

where C_n in Farad I_{rms} in Ampere f in Hertz
 V in Volt R_s in Ohm θ in $^{\circ}\text{C}$
 R_{th} in $^{\circ}\text{C/W}$

Medium Power Film Capacitors



FFB

DC FILTERING FOR LOW VOLTAGE

POLYESTER DIELECTRIC

TABLE OF VALUES

Capacitance (μF)	Box Kind	I _{rms} max. (A)	R _s (mΩ)	R _{th} (°C/W)	Part Number
V_{Ndc} 75V Vrms max.: 45 volts					
33	PO	3	3	40.7	FFB14D0336K--
47	18	4.3	2	33.3	FFB24D0476K--
68	19	6.2	1.7	29.9	FFB34D0686K--
82	26	7.4	1.6	26.7	FFB44D0826K--
110	R68 (2 terminals)	10	1.4	22.9	FFB54D0117K--
110	R68 (4 terminals)	10	1.4	22.9	FFB54D0117KJC
V_{Ndc} 100V Vrms max.: 60 volts					
20	PO	2.6	3	40.5	FFB14E0206K--
27	18	3.5	2.5	33.3	FFB24E0276K--
39	19	5	2	29.8	FFB34E0396K--
47	26	6	1.7	26.6	FFB44E0476K--
68	R68 (2 terminals)	9	1.4	22.8	FFB54E0686K--
68	R68 (4 terminals)	9	1.4	22.8	FFB54E0686KJC
V_{Ndc} 300V Vrms max.: 90 volts					
7.5	PO	2.4	16	40.7	FFB14H0755K--
11	18	3.6	11	33.5	FFB24H0116K--
16	19	5.2	8	29.9	FFB34H0166K--
18	26	6	7	27.1	FFB44H0186K--
27	R68 (2 terminals)	9	5	22.9	FFB54H0276K--
27	R68 (4 terminals)	9	5	22.9	FFB54H0276KJC
V_{Ndc} 400V Vrms max.: 105 volts					
6.2	PO	2.5	17	40.5	FFB14I0625K--
7.5	18	3.1	14	33.5	FFB24I0755K--
12	19	5	9	29.9	FFB34I0126K--
15	26	6.2	7	26.4	FFB44I0156K--
20	R68 (2 terminals)	8.2	5.5	22.8	FFB54I0206K--
20	R68 (4 terminals)	8.2	5.5	22.8	FFB54I0206KJC

DC FILTERING

LIFETIME EXPECTANCY vs VOLTAGE AND HOT SPOT TEMPERATURE

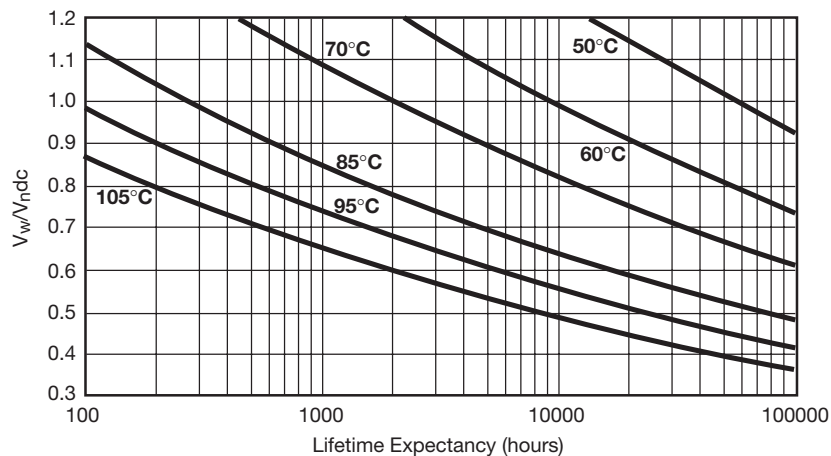

V_w = Permanent working or operating DC voltage.



DC FILTERING FOR INDUSTRIAL APPLICATION

These capacitors have been designed principally for high and medium power DC filtering applications.

ELECTRICAL CHARACTERISTICS

Capacitance range C_n	1.5 μ F to 13 μ F
Tolerance on C_n	$\pm 10\%$
Rated DC voltage $V_{n,dc}$	525 to 1100 V
Dielectric	polypropylene

TANGENT OF LOSS ANGLE ($TAN\delta_0$) FOR POLYPROPYLENE DIELECTRIC

Polypropylene has a constant dielectric loss factor of 2×10^{-4} irrespective of temperature and frequency (up to 1 MHz).

HOT SPOT TEMPERATURE CALCULATION

You can calculate the maximum operating (hot spot) temperature of this capacitor in the following manner:

The loss factor of the capacitor is made up of the sum of two components. The first represents electrical losses ($tg \delta_0 = 2 \times 10^{-4}$) and the second component represents Joule effect in the connection and foils, ($R_s \cdot C \cdot 2 \pi f$).

For all applications, the temperature in the hot spot capacitor must be lower than 105°C. Heating calculation of hot spot capacitor:

$$\theta_{hot\ spot} = \theta_{ambient} + [tg\delta_0 \cdot Q + R_s \cdot (I_{rms})^2] \cdot R_{th}$$

With:

Q : Reactive power in Var

R_s in Ohm

I_{rms} in Ampere

R_{th} : Rth ambient / hot spot in °C/W

$tg \delta_0 \cdot (10^{-4})$ is the tangent of loss angle for polypropylene dielectric. Polypropylene has a constant dielectric losses factor of 2×10^{-4} irrespective of temperature and frequency (up to 1 MHz).

Medium Power Film Capacitors



FFB

DC FILTERING FOR INDUSTRIAL APPLICATION

POLYPROPYLENE DIELECTRIC

TABLE OF VALUES

Capacitance (μF)	Box Kind	I _{rms} max. (A)	R _s (mΩ)	R _{th} (°C/W)	Part Number
V_{ndc} 525V Vrms max.: 105 volts					
3.9	PO	5.1	30	45.7	FFB16J0395K--
5.6	18	7.4	21	36.4	FFB26J0565K--
8.2	19	10.9	15	32.6	FFB36J0825K--
10	26	12	12	29.8	FFB46J0106K--
13	R68 (2 terminals)	12	9	24.3	FFB56J0136K--
13	R68 (4 terminals)	16.7	9	24.3	FFB56J0136KJC
V_{ndc} 720V Vrms max.: 120 volts					
3.3	PO	5.0	31	45.0	FFB16A0335K--
4.3	18	6.5	24	36.2	FFB26A0435K--
6.2	19	9.4	17	32.7	FFB36A0625K--
7.5	26	11.4	14	29.9	FFB46A0755K--
10	R68 (2 terminals)	12	11	24.2	FFB56A0106K--
10	R68 (4 terminals)	15.2	11	24.2	FFB56A0106KJC
V_{ndc} 900V Vrms max.: 150 volts					
2	PO	3.6	41	45.7	FFB16C0205K--
2.7	18	4.9	30	36.6	FFB26C0275K--
3.9	19	7.2	21	32.9	FFB36C0395K--
5.1	26	9.3	16	29.7	FFB46C0515K--
6.8	R68 (2 terminals)	12	12	24.1	FFB56C0685K--
6.8	R68 (4 terminals)	12.5	12	24.1	FFB56C0685KJC
V_{ndc} 1100V Vrms max.: 180 volts					
1.5	PO	3.3	45	45.2	FFB16L0155K--
1.8	18	3.9	40	36.5	FFB26L0185K--
2.4	19	5.3	28	33.4	FFB36L0245K--
3	26	6.6	23	30.2	FFB46L0305K--
4.7	R68 (2 terminals)	10.3	15	24.1	FFB56L0475K--
4.7	R68 (4 terminals)	10.3	15	24.1	FFB56L0475KJC

DC FILTERING

LIFETIME EXPECTANCY vs VOLTAGE AND HOT SPOT TEMPERATURE

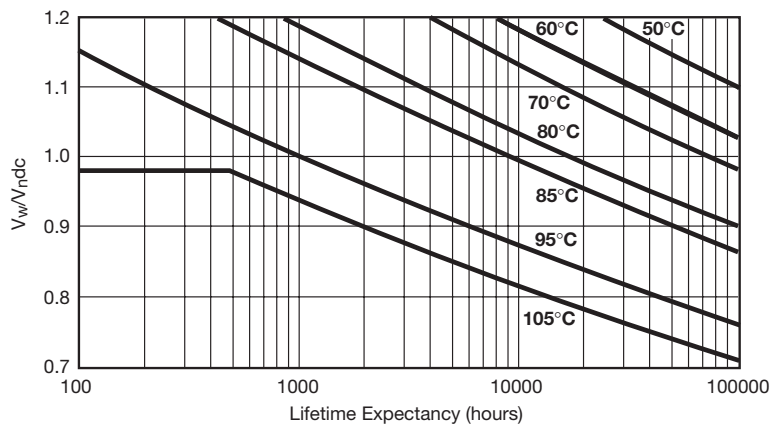

V_w = Working DC Voltage
V_n = Rated DC Voltage



Medium Power Film Capacitors



FFV3 General Description

DC FILTERING

DC FILTERING

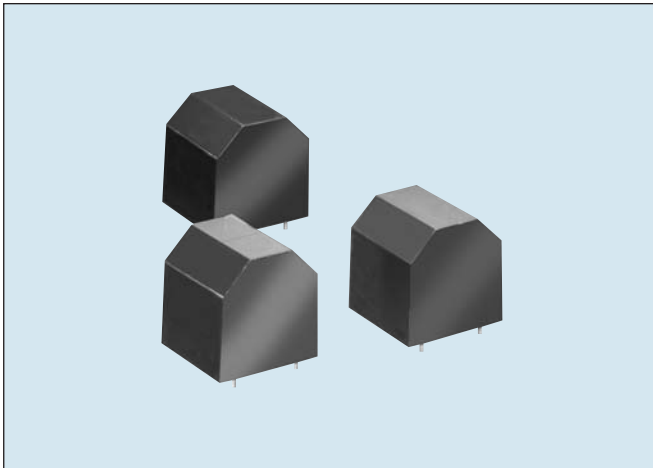

The series uses a non-impregnated metallized polypropylene or polyester dielectric, with the controlled self-healing process, specially treated to have a very high dielectric strength in operating conditions up to 105°C.

The FFV3 has been designed for printed circuit board mounting.

APPLICATIONS

The FFV3 capacitors are particularly designed for DC filtering, low reactive power.

PACKAGING

Self-extinguishing plastic case (V0 = in accordance with UL 94) filled thermosetting resin.

Self-extinguishing thermosetting resin (V0 = in accordance with UL 94; I3F2 = in accordance with NF F 16-101).

LIFETIME EXPECTANCY

One unique feature of this technology (as opposed to electrolytics) is how the capacitor reacts at the end of its lifetime. Whereas, with an electrolytic, there is a strong risk of explosion of the case. However, with our line of film capacitors, the capacitor will simply experience at the end of life a loss of capacitance of about 2%, with no risk of explosion.

Please note that this is theoretical, however, as the capacitor continues to be functional even after this 2% decrease.

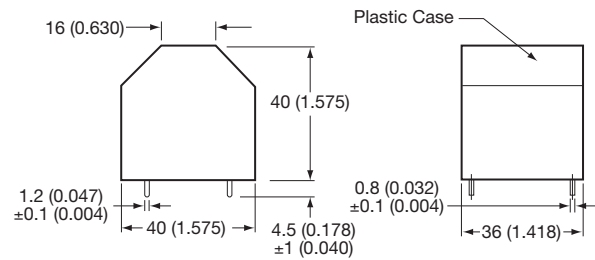
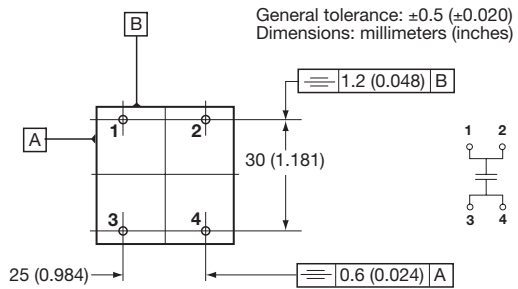

STANDARDS

- IEC 61071-1, IEC 61071-2: Power electronic capacitors
- IEC 60384-16: Fixed metallized polypropylene film dielectric DC capacitors
- IEC 60384-16-1: Fixed metallized polypropylene film dielectric DC capacitors
Assessment level E
- IEC 60384-17: Fixed metallized polypropylene film dielectric AC and pulse capacitors
- IEC 60384-17-1: Fixed metallized polypropylene film dielectric AC and pulse capacitors
Assessment level E
- IEC 60384-2: Fixed metallized polyester capacitors

ELECTRICAL CHARACTERISTICS

Climatic category	40/105/56 (IEC 60068)
Test voltage between terminals @ 25°C	1.5 x V_{Ndc} during 10s
Test voltage between terminals and case @ 25°C	@ 4 kVrms @ 50 Hz during 1 min.



Medium Power Film Capacitors



FFV3 for Low Voltage Applications

DC FILTERING

POLYESTER DIELECTRIC

ELECTRICAL CHARACTERISTICS

Capacitance range C_n	30 μ F to 160 μ F
Tolerance on C_n	$\pm 10\%$
Rated DC voltage V_{ndc}	75 to 400 V
Dielectric	polyester

DC FILTERING

Capacitance (μ F)	$I_{rms\ max.}$ (A)	$(I^2t)_{10\ shots}$ (A^2s)	$(I^2t)_{1000\ shots}$ (A^2s)	R_s (m Ω)	R_{th} ($^{\circ}C/W$)	Part Number
$V_{ndc} = 75\ V$ $V_{rms} = 45\ v\ max$						
130	23	370	37	0.56	5.60	FFV34D0137K--
160	28	560	56	0.47	5.00	FFV34D0167K--
$V_{ndc} = 100\ V$ $V_{rms} = 60\ v\ max$						
80	19	250	25	0.67	6.16	FFV34E0806K--
100	24	390	39	0.55	5.42	FFV34E0107K--
$V_{ndc} = 160\ V$ $V_{rms} = 75\ v\ max$						
55	17	180	18	0.77	6.56	FFV34F0556K--
65	20	260	26	0.66	5.97	FFV34F0656K--
$V_{ndc} = 300\ V$ $V_{rms} = 90\ v\ max$						
40	20	150	15	2.80	9.58	FFV34H0406K--
50	26	230	23	2.25	8.46	FFV34H0506K--
$V_{ndc} = 400\ V$ $V_{rms} = 105\ v\ max$						
30	17	110	11	2.93	9.92	FFV34I0306K--
40	23	200	20	2.21	8.41	FFV34I0406K--

LIFETIME EXPECTANCY vs V_w/V_{ndc} AND HOT SPOT TEMPERATURE

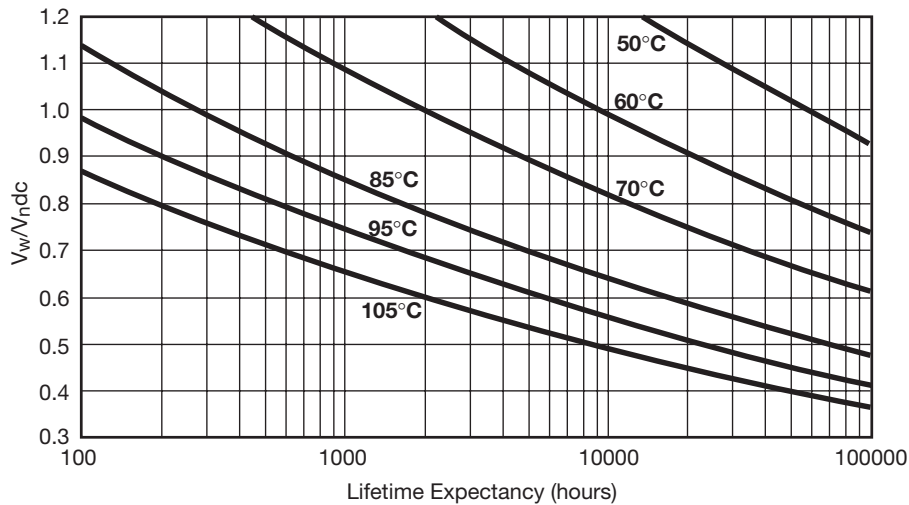

V_w = Permanent working or operating DC voltage.

HOT SPOT CALCULATION

$$\theta_{hot\ spot} = \theta_{ambient} + (P_d + P_t) \times (R_{th} + 7.4)$$

$$\theta_{hot\ spot} = \theta_{case} + (P_d + P_t) \times R_{th}$$

with P_d (Dielectric losses) = $Q \times tg\delta_0$
 $\Rightarrow [\frac{1}{2} \times C_n \times (V_{peak\ to\ peak})^2 \times f] \times tg\delta_0$
 (see $tg\delta_0$ curves page 3)

$$P_t \text{ (Thermal losses)} = R_s \times (I_{rms})^2$$

where C_n in Farad I_{rms} in Ampere f in Hertz
 V in Volt R_s in Ohm θ in $^{\circ}C$
 R_{th} in $^{\circ}C/W$ R_{th} : R_{th} case/hot spot in $^{\circ}C/W$



Medium Power Film Capacitors



FFV3 DC for Medium and High Voltage Applications

DC FILTERING

DC FILTERING

POLYPROPYLENE DIELECTRIC

ELECTRICAL CHARACTERISTICS

Capacitance range C_n	6 μ F to 25 μ F
Tolerance on C_n	$\pm 10\%$
Rated DC voltage V_{ndc}	500 to 1100 V
Dielectric	polypropylene

Capacitance (μ F)	$I_{rms\ max.}$ (A)	$(I^2t)_{10\ shots}$ (A ² s)	$(I^2t)_{1000\ shots}$ (A ² s)	R_s (m Ω)	R_{th} ($^{\circ}$ C/W)	Part Number
$V_{ndc} = 500\ V$		$V_{rms} = 105\ v\ max$				
20	27	3200	320	5.88	3.53	FFV36J0206K--
25	33	5000	500	4.72	3.14	FFV36J0256K--
$V_{ndc} = 700\ V$		$V_{rms} = 120\ v\ max$				
14	21	2000	200	7.34	3.73	FFV36A0146K--
20	30	4200	420	5.15	3.05	FFV36A0206K--
$V_{ndc} = 900\ V$		$V_{rms} = 150\ v\ max$				
10	19	1600	160	8.21	3.37	FFV36C0106K--
13	25	2800	280	6.33	2.91	FFV36C0136K--
$V_{ndc} = 1100\ V$		$V_{rms} = 180\ v\ max$				
6	13	800	80	11.4	3.71	FFV36L0605K--
9	20	1900	190	7.61	2.92	FFV36L0905K--

LIFETIME EXPECTANCY vs V_w/V_n AND HOT SPOT TEMPERATURE

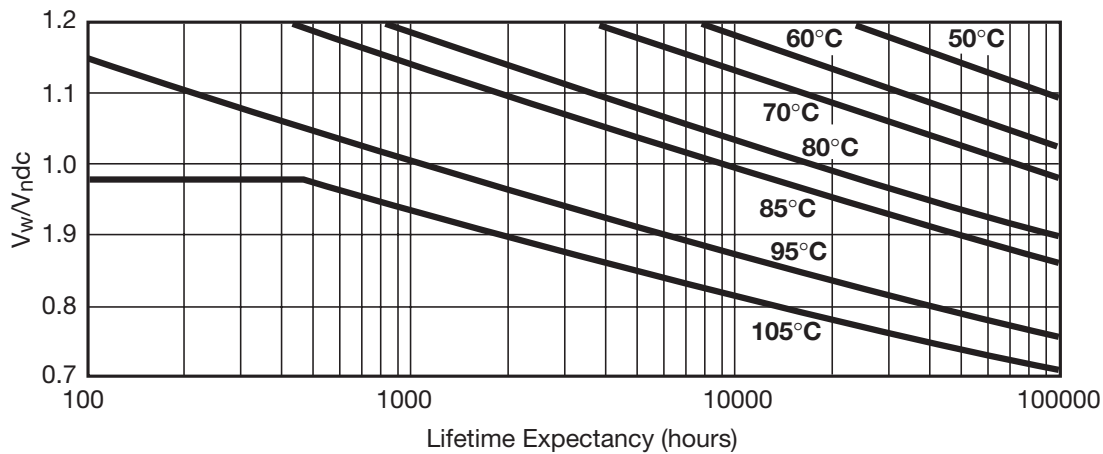

V_w = Permanent working or operating DC voltage.

HOT SPOT CALCULATION

$$\theta_{hot\ spot} = \theta_{ambient} + (P_d + P_t) \times (R_{th} + 7.4)$$

$$\theta_{hot\ spot} = \theta_{case} + (P_d + P_t) \times R_{th}$$

with P_d (Dielectric losses) = $Q \times tg\delta_0$

$$\Rightarrow [\frac{1}{2} \times C_n \times (V_{peak\ to\ peak})^2 \times f] \times (2 \times 10^{-4})$$

$$P_t \text{ (Thermal losses)} = R_s \times (I_{rms})^2$$

where C_n in Farad I_{rms} in Ampere f in Hertz
 V in Volt R_s in Ohm θ in $^{\circ}$ C
 R_{th} in $^{\circ}$ C/W R_{th} : R_{th} case/hot spot in $^{\circ}$ C/W



Medium Power Film Capacitors



FFG Design

DC FILTERING

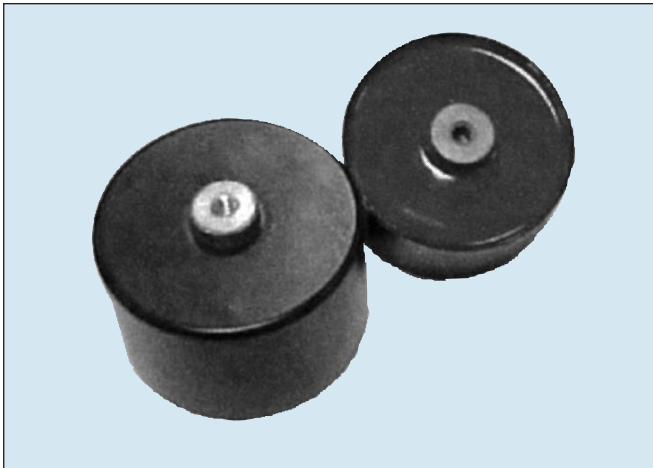

DESIGN

plastic case – Outputs: threaded insert M8 filled with thermosetting resin

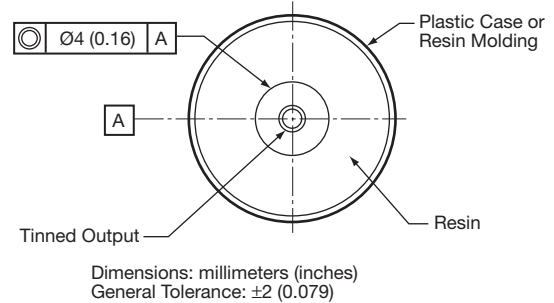
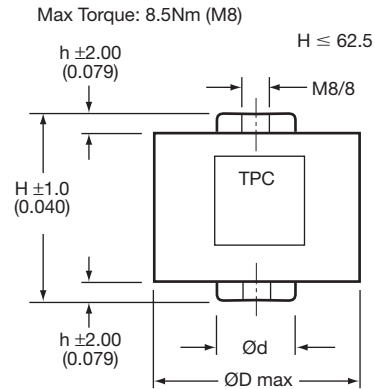

GENERAL DESCRIPTION

The FFG series uses a non-impregnated metallized dielectric, which features a controlled self-healing process.

PACKAGING

Self-extinguishing plastic case (V0 = in accordance with UL 94) filled thermosetting resin. Self-extinguishing thermosetting resin (V0 = in accordance with UL 94; I3F1 = in accordance with NF F 16-101).

ELECTRICAL CHARACTERISTICS

Operating temperature:	-40°C + 105°C
Storage temperature:	-55°C + 85°C
Capacitance range:	5µF to 160µF
Rated DC voltage V _{ndc} :	600 to 1900 V
Capacitance tolerance:	±10%
Test voltage between terminals:	@ 25°C: 1.5 x U _{n,dc} during 10s
Test voltage between terminals and case:	@ 25°C: @ 4 kV _{rms} @ 50 Hz during 1 mn (test type)

HOT SPOT CALCULATION

$$\theta_{\text{hot spot}} = \theta_{\text{terminal}} + (P_d + P_t) \times R_{\text{th}}$$

with P_d (Dielectric losses) = $Q \times \text{tg}\delta_0$ $\text{tg}\delta_0 = 2.10$

$$Q = \frac{I_{\text{rms}}^2}{C \cdot 2 \cdot \pi \cdot f}$$

$$P_t \text{ (Thermal losses)} = R_s \times I_{\text{rms}}^2$$

where C_n in Farad I_{rms} in Ampere f in Hertz
 V in Volt R_s in Ohm θ in °C
 R_{th} in °C/W

STANDARDS

- IEC 61071-1, IEC 61071-2: Power electronic capacitors
- IEC 60068-1: Environmental testing
- UL 94: Fire requirement

Medium Power Film Capacitors



FFG Design

DC FILTERING

C _n (μF)	Height ±1 (±0.039)	h ±2 (±0.079)	D max	d ±0.50 (±0.020)	I ² t max (A ² s)	I _{rms} max (A)	R _s (mΩ)	R _{th} (°C/W)	Part Number
U_{ndc} 600 V									
37	52 (2.072)	5 (0.197)	60 (2.362)	22 (0.866)	4	28	1.3	10.1	FFG86K0376K--
58	52 (2.072)	5 (0.197)	72 (2.835)	22 (0.866)	10	44	1	6.4	FFG86K0586K--
80	52 (2.072)	5 (0.197)	82 (3.228)	22 (0.866)	20	61	0.7	4.9	FFG86K0806K--
160	62.5 (2.461)	5 (0.197)	92 (3.622)	22 (0.866)	32	76	0.8	5.8	FFG86K0167K--
U_{ndc} 800 V									
23	52 (2.072)	5 (0.197)	60 (2.362)	22 (0.866)	3	26	1.7	10.1	FFG86B0236K--
37	52 (2.072)	5 (0.197)	72 (2.835)	22 (0.866)	8	43	1.2	6.5	FFG86B0376K--
51	52 (2.072)	5 (0.197)	82 (3.228)	22 (0.866)	15	59	0.9	4.8	FFG86B0516K--
100	62.5 (2.461)	5 (0.197)	92 (3.622)	22 (0.866)	24	73	1	5.9	FFG86B0107K--
U_{ndc} 900 V									
16	52 (2.072)	5 (0.197)	60 (2.362)	22 (0.866)	2.8	27	2	9.8	FFG86C0166K--
26	52 (2.072)	5 (0.197)	72 (2.835)	22 (0.866)	7	44	1.3	6.5	FFG86C0266K--
35	52 (2.072)	5 (0.197)	82 (3.228)	22 (0.866)	13	60	1	4.8	FFG86C0356K--
70	62.5 (2.461)	5 (0.197)	92 (3.622)	22 (0.866)	20	75	1.2	5.8	FFG86C0706K--

LIFETIME EXPECTANCY vs HOT SPOT TEMPERATURE AND VOLTAGE

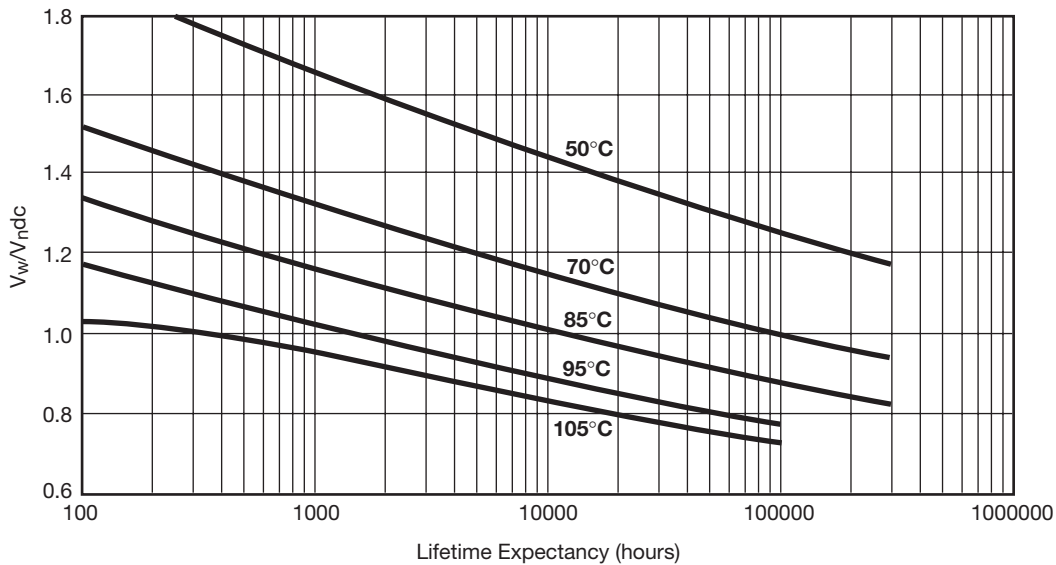

V_w = Permanent working or operating DC voltage.



Medium Power Film Capacitors



FFG Design

DC FILTERING

C _n (μF)	Height ±1 (±0.039)	h ±2 (±0.079)	D max	d ±0.50 (±0.020)	I ² t max (A ² s)	I _{rms} max (A)	R _s (mΩ)	R _{th} (°C/W)	Part Number
U_ndc 1000 V									
25	52 (2.072)	5 (0.197)	60 (2.362)	22 (0.866)	1.9	21	3.6	9.9	FFG86L0256KJ7
40	52 (2.072)	5 (0.197)	72 (2.835)	22 (0.866)	5	34	2.32	6.4	FFG86L0406KJ7
55	52 (2.072)	5 (0.197)	82 (3.228)	22 (0.866)	9.5	46	1.74	4.7	FFG86L0556KJ7
110	62.5 (2.461)	5 (0.197)	92 (3.622)	22 (0.866)	14.9	58	1.86	5.7	FFG86L0117KJ7
U_ndc 1200 V									
17	52 (2.072)	5 (0.197)	60 (2.362)	22 (0.866)	1.3	19	4.33	9.9	FFG86U0176KJ7
27	52 (2.072)	5 (0.197)	72 (2.835)	22 (0.866)	3.3	30	2.8	6.5	FFG86U0276KJ7
37	52 (2.072)	5 (0.197)	82 (3.228)	22 (0.866)	6.2	41	2.1	4.8	FFG86U0376KJ7
76	62.5 (2.461)	5 (0.197)	92 (3.622)	22 (0.866)	10.3	53	2.2	5.6	FFG86U0766KJ7
U_ndc 1900 V									
5	52 (2.072)	5 (0.197)	60 (2.362)	22 (0.866)	1.7	19	2.77	11.3	FFG86N0505KJ7
9	52 (2.072)	5 (0.197)	72 (2.835)	22 (0.866)	5.5	35	1.63	6.6	FFG86N0905KJ7
12	52 (2.072)	5 (0.197)	82 (3.228)	22 (0.866)	9.9	46	1.27	5	FFG86N0126KJ7
25	62.5 (2.461)	5 (0.197)	92 (3.622)	22 (0.866)	18	63	1.2	5.2	FFG86N0256KJ7

LIFETIME EXPECTANCY vs HOT SPOT TEMPERATURE AND VOLTAGE

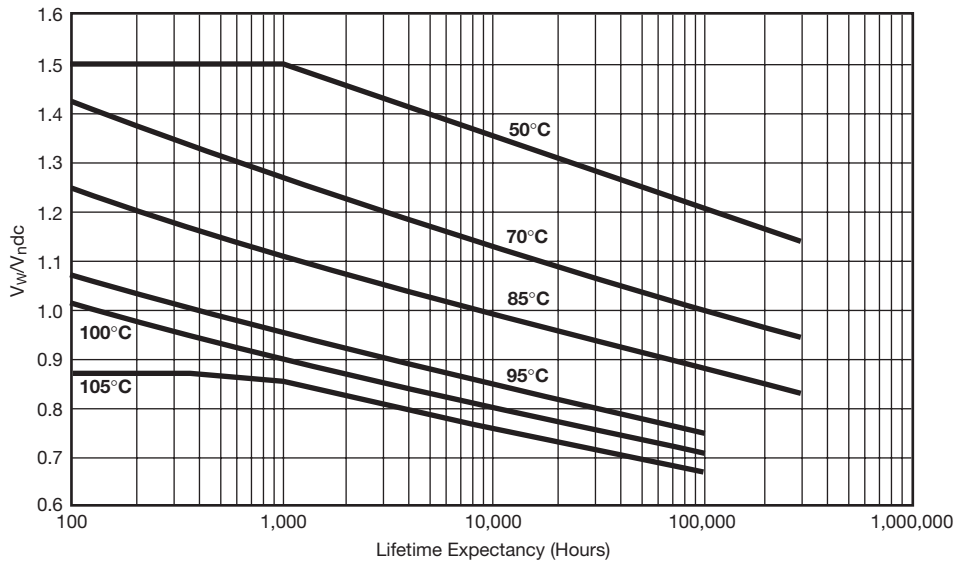

V_w = Permanent working or operating DC voltage.

Medium Power Film Capacitors



FFVE/FFVI Male and Female Connections

DC FILTERING

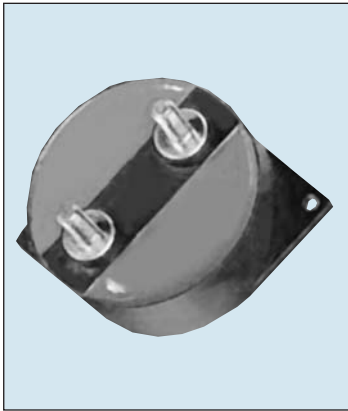

GENERAL DESCRIPTION

The FFV capacitor is specifically designed for DC filtering, low reactive power.

The series uses a non-impregnated metallized polypropylene or polyester dielectric, which features a controlled self-healing process, specially treated to have a very high dielectric strength in operating conditions up to 105°C.

The FFV special design gives this series a very low level of stray inductance (18 nH to 40 nH).

Furthermore, the performance levels of the FFVE capacitor makes them a very interesting alternative to electrolytic technology, because they can withstand much higher levels of surge voltage, very high rms current ratings, and longer lifetimes.

PACKAGING

Self-extinguishing plastic case (V0 = in accordance with UL 94) filled thermosetting resin.

Self-extinguishing thermosetting resin (V0 = in accordance with UL 94; I3F1 = in accordance with NF F 16-101).

FFVE capacitors meet the Level 2 requirement of the fire behavior standard NF F 16-102.

DESIGN - Also available with threaded female connections - M5 x 7.5mm max Torque 2.5Nm

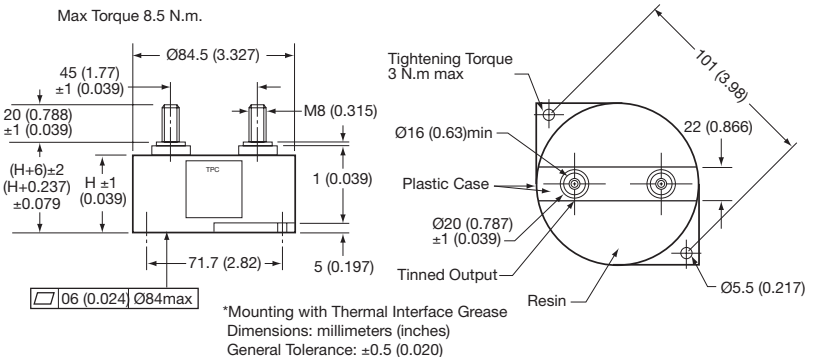

ELECTRICAL CHARACTERISTICS

The FFVE for low voltage DC filtering are polyester dielectric capacitors.

Working temperature	-40°C to +105°C (according to the power to be dissipated)
Capacitance range	12µF to 400µF
Capacitance tolerance	±10%
Rated DC voltage	300 to 1900 V
Test voltage between terminals @ 25°C	1.5 x V _n dc 10s (1.25 V _n dc – 10s for FFVI)
Insulation voltage between shorted terminals and earth	4 kVrms/60sec/50Hz

Rs(f) vs FREQUENCY

For frequency higher than 1 kHz use following curve

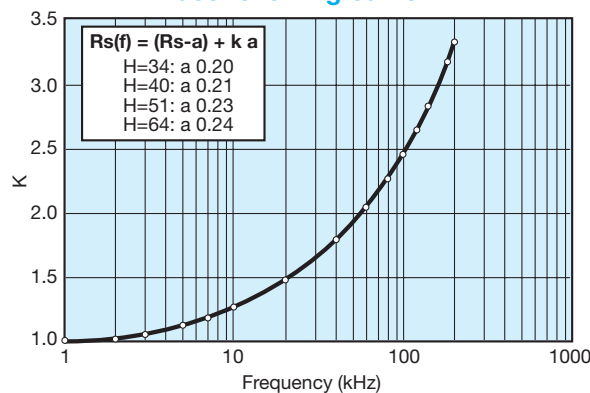

Medium Power Film Capacitors



FFVE/FFVI Male and Female Connections

POLYESTER DIELECTRIC

Dimensions: millimeters (inches)

Capacitance (μF)	Height	Irms max. (A)	Ls max. (nH)	Rs (mΩ)	Rth (°C/W)	Part Number*
V_ndc 300 volts						
180	34 (1.339)	100	18	0.8	4.7	FFVE4H0187K--
195	34 (1.339)	100	18	0.8	4.4	FFVE4H1956K--
250	40 (1.575)	100	25	0.6	5.2	FFVE4H0257K--
350	51 (2.008)	100	32	0.8	7.2	FFVE4H0357K--
400	51 (2.008)	110	32	0.8	7.1	FFVE4H0407K--
V_ndc 400 volts						
100	34 (1.339)	80	18	0.7	4.7	FFVE4I0107K--
120	34 (1.339)	100	18	0.6	4.1	FFVE4I0127K--
150	40 (1.575)	100	25	0.7	5.0	FFVE4I0157K--
180	51 (2.008)	80	32	1.0	8.5	FFVE4I0187K--
220	51 (2.008)	100	32	0.9	7.2	FFVE4I0227K--

*Change "K--" to "KJE" for female connectors M5 x 7.5mm

LIFETIME EXPECTANCY FFVE POLYESTER

V_w: permanent working or operating DC voltage.

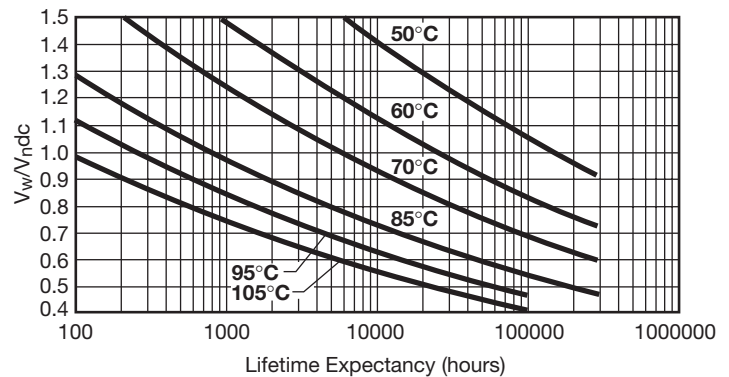

POLYPROPYLENE DIELECTRIC

Capacitance (μF)	Height	Irms max. (A)	Ls max. (nH)	Rs (mΩ)	Rth (°C/W)	Part Number*
V_ndc 600 volts						
25	34 (1.339)	90	18	0.7	4.3	FFVE6K0256K--
100	40 (1.575)	100	25	0.6	4.8	FFVE6K0107K--
150	51 (2.008)	110	32	0.9	6.9	FFVE6K0157K--
220	64 (2.520)	100	40	1.0	8.4	FFVE6K0227K--
V_ndc 800 volts						
66	40 (1.575)	100	25	0.7	4.7	FFVE6B0666K--
100	51 (2.008)	90	32	1.0	6.7	FFVE6B0107K--
140	64 (2.520)	100	40	1.3	8.4	FFVE6B0147K--
V_ndc 900 volts						
12	34 (1.339)	70	18	0.9	4.4	FFVE6C0126K--
38	34 (1.339)	100	18	1.6	3.9	FFVE6C0386K--
47	40 (1.575)	100	25	0.8	4.6	FFVE6C0476K--
70	51 (2.008)	100	32	1.2	6.7	FFVE6C0706K--
100	64 (2.520)	90	40	1.1	8.2	FFVE6C0107K--
V_ndc 1000 volts						
66	40 (1.575)	70	25	1.5	5.1	FFVE6L0666KJ7
100	51 (2.008)	64	32	2.0	7.3	FFVE6L0107KJ7
140	64 (2.520)	51	40	2.5	9.2	FFVE6L0147KJ7
V_ndc 1200 volts						
47	40 (1.575)	66	25	1.7	4.9	FFVE6U0476KJ7
70	51 (2.008)	59	32	2.4	7.2	FFVE6U0706KJ7
100	64 (2.520)	49	40	2.9	8.9	FFVE6U0107KJ7
V_ndc 1900 volts						
15	40 (1.575)	73	25	1.1	5.2	FFVE6N0156KJ7
24	51 (2.008)	73	32	1.3	6.5	FFVE6N0246KJ7
35	64 (2.520)	67	40	1.6	8.4	FFVE6N0356KJ7

*Change "K--" to "KJE" for female connectors M5 x 7.5mm

*Change "KJ7" to "K7X" for female connectors M5 x 7.5mm



Medium Power Film Capacitors



FFVE/FFVI Male and Female Connections

LIFETIME EXPECTANCY FOR FFVE POLYPROPYLENE

K-- and KJE

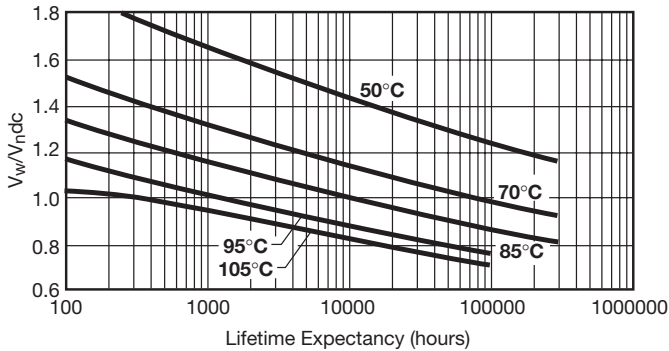

KJ7 and K7X

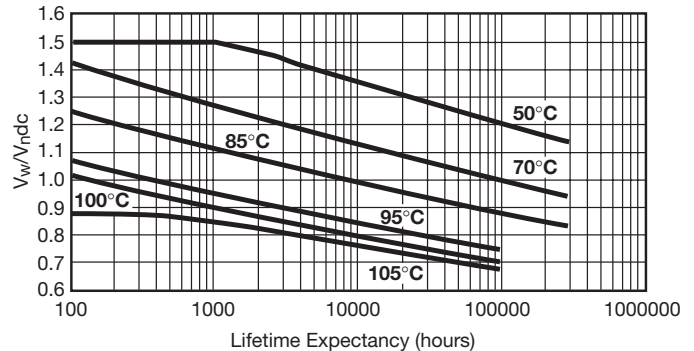

V_w : permanent working or operating DC-voltage.

V_w : permanent working or operating DC-voltage.

DC FILTERING

POLYPROPYLENE DIELECTRIC

Capacitance (μF)	Height	Irms max. (A)	Ls max. (nH)	Rs (mΩ)	Rth (°C/W)	Part Number*
V_{ndc} 500 volts						
125	40 (1.575)	90	25	0.6	5.0	FFVI6J1256K--
200	51 (2.008)	90	32	0.8	6.7	FFVI6J0207K--
275	64 (2.520)	90	40	0.9	8.7	FFVI6J2756K--
V_{ndc} 700 volts						
100	40 (1.575)	100	25	0.6	4.8	FFVI6A0107K--
150	51 (2.008)	100	32	0.9	6.9	FFVI6A0157K--
220	64 (2.520)	100	40	1.0	8.4	FFVI6A0227K--
V_{ndc} 900 volts						
66	40 (1.575)	100	25	0.7	4.7	FFVI6C0666K--
100	51 (2.008)	90	32	1.0	6.7	FFVI6C0107K--
140	64 (2.520)	100	40	1.3	8.4	FFVI6C0147K--
V_{ndc} 1100 volts						
47	40 (1.575)	100	25	0.8	4.6	FFVI6L0476K--
70	51 (2.008)	100	32	1.2	6.7	FFVI6L0706K--
100	64 (2.520)	90	40	1.1	8.2	FFVI6L0107K--

*Change "K--" to "KJE" for female connectors M5 x 7.5mm

LIFETIME EXPECTANCY FOR FFVI

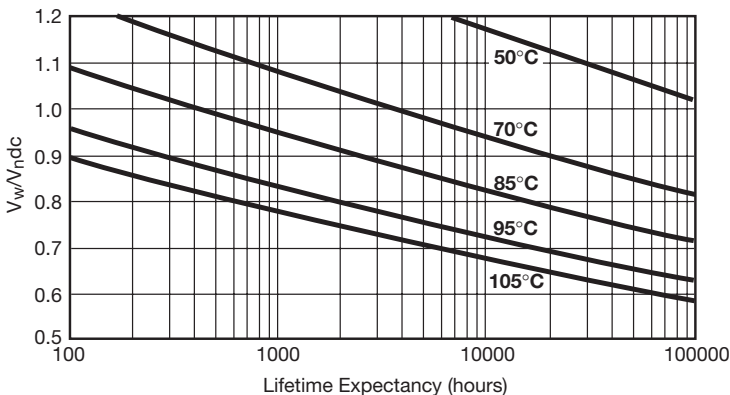

V_w : permanent working or operating DC-voltage.

HOT SPOT CALCULATION

$$\theta_{hot\ spot} = \theta_{case} + (P_d + P_t) \times R_{th}$$

with P_d (Dielectric losses) = $Q \times tg\delta_0$
 $\Rightarrow [\frac{1}{2} \times C_n \times (V_{peak\ to\ peak})^2 \times f] \times tg\delta_0$
 (see $tg\delta_0$ vs dielectric pages 2 and 3)

$$P_t \text{ (Thermal losses)} = R_s \times (I_{rms})^2$$

where C_n in Farad I_{rms} in Ampere f in Hertz
 V in Volt R_s in Ohm θ in °C
 R_{th} in °C/W R_{th} hot spot/bottom case



Medium Power Film Capacitors



FFLI Design

DC FILTERING



PACKAGING - also available with female connections

Cylindrical resin-filled aluminum case.

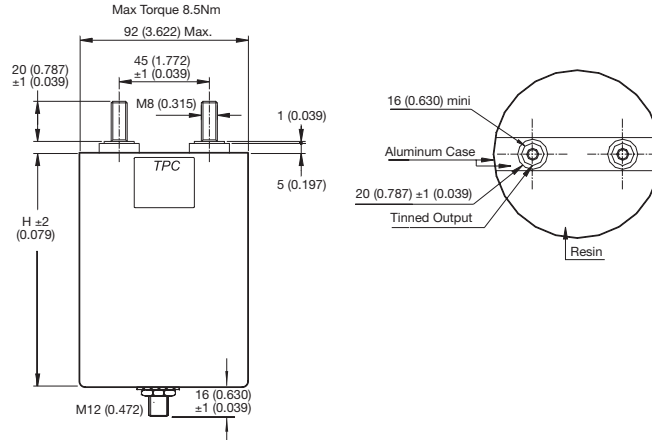

DC FILTERING

ELECTRICAL CHARACTERISTICS

Capacitance range C_n	160 μ F to 390 μ F
Tolerance on C_n	$\pm 10\%$
Rated DC voltage V_{ndc}	1000 to 1200 V
Maximum rms current $I_{rms\ max}$	60 Arms
Stray inductance L_s	60 nH to 85 nH
Test voltage between terminals @ 25°C	1.5 V_{ndc} 10 s
Test voltage between terminals and case @25°C	4 kVrms @ 50 Hz during 1 min.

POLYPROPYLENE DIELECTRIC

mm (inches)

Capacitance (μ F)	Height	I_{rms} (A)	L_s (nH)	R_s (m Ω)	R_{th} ($^{\circ}$ C/W)	Weight (kg)	Part Number
$V_{ndc} = 1000$ V							
390	145 (5.709)	60	85	5.2	2.4	1.2	FFLI6L0397K--
230	97 (3.819)	60	60	3.5	3.1	0.8	FFLI6L0237K--
$V_{ndc} = 1200$ V							
270	145 (5.709)	60	85	6.1	2.4	1.2	FFLI6U0277K--
160	97 (3.819)	60	60	4.1	3.1	0.8	FFLI6U0167K--

ELECTRICAL CHARACTERISTICS

Maximum overvoltage (V_s): $V_s = 1.8 V_{ndc}$

Voltages and overvoltages withstanding for 100,000 hours at V_{ndc} and 50°C hot spot temperature:

Voltage Value	Duration
$V_{dc} = 1.67 \times V_{ndc}$	$\leq 100ms$ _1 time per day
$+V_{dc} = 1.5 \times V_{ndc}$	5 min_1 time per day
$+V_{dc} = 1.3 \times V_{ndc}$	2.5 hours_1 time per day
$+V_{dc} = 1.1 \times V_{ndc}$	40% of the On-load duration
$+V_{dc} = V_{ndc}$	$\cong 50\%$ of the On-load duration
Sum	100,000 hours

LIFETIME EXPECTANCY vs HOT SPOT TEMPERATURE AND VOLTAGE

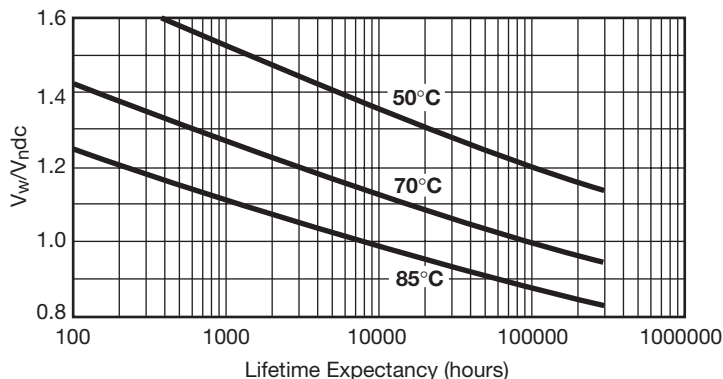

V_w : permanent working or operating DC-voltage.

HOT SPOT CALCULATION

$$\theta_{hot\ spot} = \theta_{ambient} + (P_d + P_t) \times R_{th}$$

with P_d (Dielectric losses) = $Q \times tg\delta_0$
 $\Rightarrow [\frac{1}{2} \times C_n \times (V_{peak\ to\ peak})^2 \times f] \times (2 \times 10^{-4})$

$$P_t \text{ (Thermal losses)} = R_s \times (I_{rms})^2$$

where C_n in Farad I_{rms} in Ampere f in Hertz
 V in Volt R_s in Ohm θ in $^{\circ}$ C
 R_{th} in $^{\circ}$ C/W



Medium Power Film Capacitors



FFLB Design

DC FILTERING

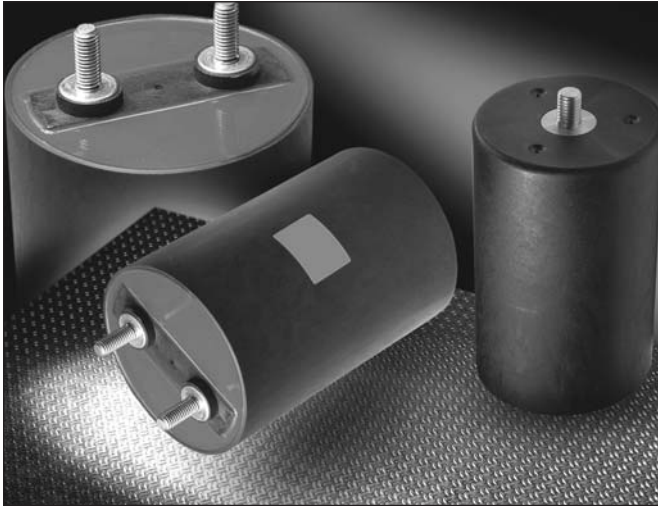

APPLICATIONS

The FFLB is specifically designed for DC filtering, low reactive power.

PACKAGING

Self-extinguishing plastic case (V-0 in accordance with UL 94; M2 in accordance with NFP 92-507; Type GET-30F in accordance with mil-M-24519) filled thermosetting resin.

FFLB capacitors meet the level 2 requirement of the fire behavior standard NF F 16 102.

PRESENTATION

Cylindric resin filled plastic case

2 x M8 terminals

Available with M5*7.5 female terminal upon request (last codification digit "--" become in that case "JE")

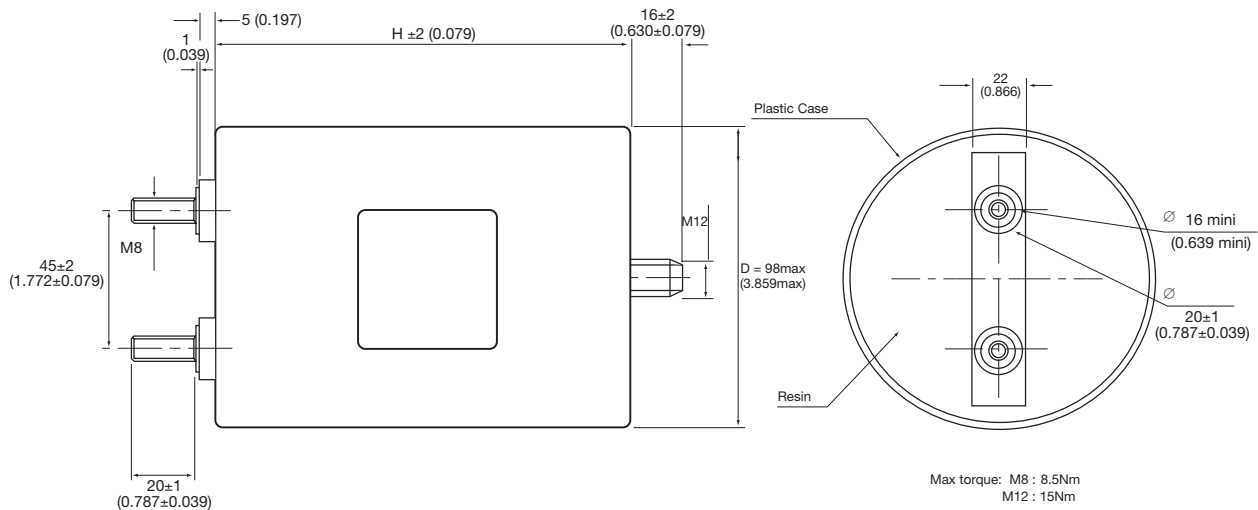

ELECTRICAL CHARACTERISTICS

Climatic Category	40/95/56 (IEC 60068)
Test Voltage Between Terminals	@ 25°C: 1.5 x U _{dc} during 10s
Test Voltage Between Terminals and Case (Type test for FFLB, routine test for FFLC)	@ 25°C: @ 4 kVrms @ 50Hz during 1 min.
Standards	IEC 61071-1 IEC 61071-2: Power electronic capacitors IEC 60068-1: Environmental testing IEC 60077: Rules for electric traction equipment UL 94: Fire requirements NF F 16-101: Fire and smoke requirements NF F 16-102: Fire and smoke requirements



Medium Power Film Capacitors



FFLB Design

DC FILTERING

ELECTRICAL CHARACTERISTICS

Capacitance Range C_N	58 μ F to 800 μ F
Tolerance on C_N	$\pm 10\%$
Rated DC Voltage U_N dc	680 to 1900 V
Maximum rms Current I_{rms} max	up to 60 Arms
Stray Inductance L_s	60 to 100 nH

FFLB

Part Number	Capacitance (μ F)	Height mm (in)	Irms (A)	Ls (nH)	Rs (m Ω)	Rth ($^{\circ}$ C/W)	Weight (kg)
U_N dc: 680 V							
FFLB6A0807K--	800	170 (6.693)	45	100	6.5	3.2	1.5
FFLB6A0657K--	650	145 (5.709)	60	85	5.6	3.3	1.3
FFLB6A0387K--	380	97 (3.819)	60	60	3.6	3.4	0.9
U_N dc: 1000 V							
FFLB6L0467K--	460	170 (6.693)	45	100	6.1	3.2	1.5
FFLB6L0397K--	390	145 (5.709)	60	85	5.2	3.3	1.3
FFLB6L0237K--	230	97 (3.819)	60	60	3.5	3.7	0.9
U_N dc: 1200 V							
FFLB6U0327K--	320	170 (6.693)	45	100	7.2	3.2	1.5
FFLB6U0277K--	270	145 (5.709)	60	85	6.1	3.3	1.3
FFLB6U0167K--	160	97 (3.819)	60	60	4.1	3.7	0.9
U_N dc: 1900 V							
FFLB6N1256K--	125	170 (6.693)	50	100	3.8	3.1	1.5
FFLB6N0107K--	100	145 (5.709)	55	85	3.4	3.3	1.3
FFLB6N0586K--	58	97 (3.819)	60	60	2.3	3.4	0.9

LIFETIME EXPECTANCY vs HOT SPOT TEMPERATURE AND VOLTAGE

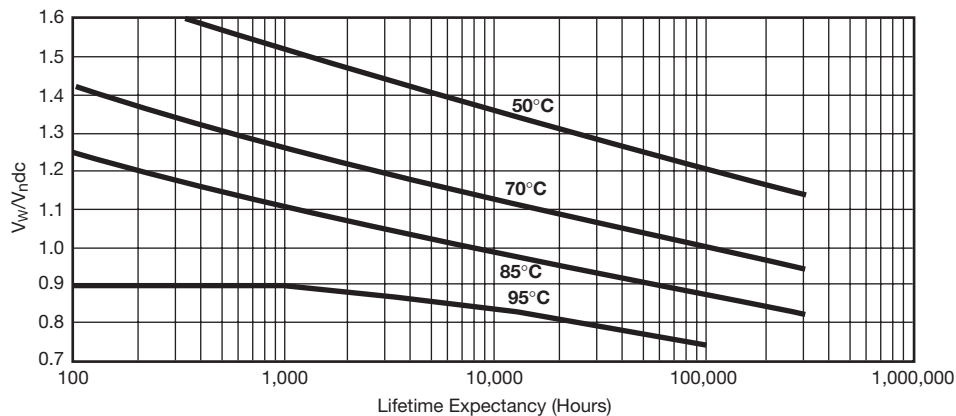

V_w : permanent working or operating DC-voltage.

HOT SPOT CALCULATION

$$\theta_{hot\ spot} = \theta_{ambient} + (P_d + P_t) \times R_{th}$$

with P_d (Dielectric losses) = $Q \times tg\delta_0$
 $\Rightarrow [\frac{1}{2} \times C_n \times (V_{peak\ to\ peak})^2 \times f] \times (2 \times 10^{-4})$
 P_t (Thermal losses) = $R_s \times (I_{rms})^2$

where C_n in Farad I_{rms} in Ampere f in Hertz V in Volt R_s in Ohm θ in $^{\circ}$ C R_{th} in $^{\circ}$ C/W



Medium Power Film Capacitors



FFLC Design

DC FILTERING

DC FILTERING

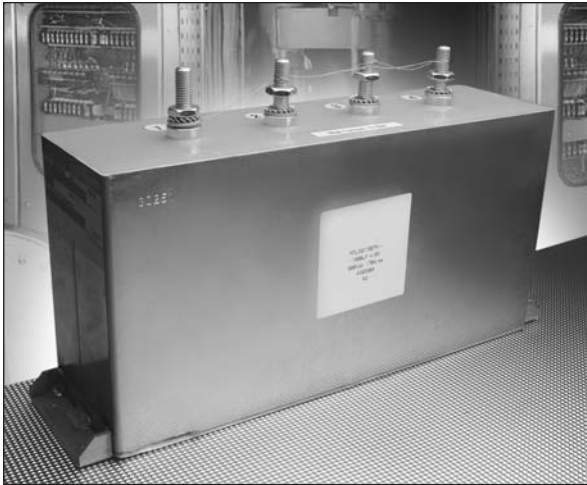

APPLICATIONS

The FFLC is specifically designed for DC filtering, low reactive power.

PACKAGING

Rectangular resin filled aluminum case.

FFLC capacitors meet the level 2 requirement of the fire behavior standard NF F 16 102.

PRESENTATION

Non-painted rectangular resin filled plastic case

4 x M10 terminals*

NEW Available with M10 X 12 female terminal upon request (last codification digit "--" become in that case "JE")

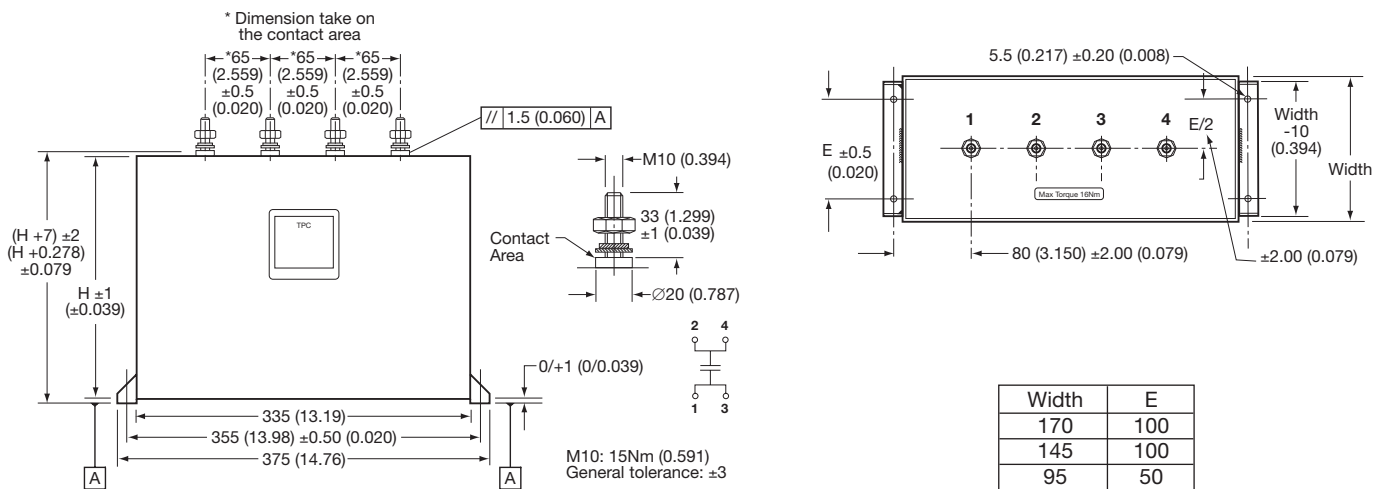

ELECTRICAL CHARACTERISTICS

Climatic Category	40/85/56 (IEC 60068)
Test Voltage Between Terminals	@ 25°C: 1.5 x U _{N,dc} during 10s
Test Voltage Between Terminals and Case (Type test for FFLB, routine test for FFLC)	@ 25°C: @ 4 kVrms @ 50Hz during 1 min.

Medium Power Film Capacitors



FFLC Design

ELECTRICAL CHARACTERISTICS

Capacitance range C_n	1120 μ F to 8800 μ F (other values available upon request)
Tolerance on C_n	$\pm 10\%$
Rated DC voltage $V_{n\text{dc}}$	680 to 1200 V
Maximum rms current $I_{\text{rms max}}$	140 Arms to 300 Arms
Stray inductance L_s^*	28 nH to 40 nH

FFLC

Part Number	Capacitance (μ F)	Height mm (in)	Width mm (in)	I_{rms} (A)	L_s^* (nH)	R_s (m Ω)	R_{th} ($^{\circ}$ C/W)	Weight (kg)
U_N dc: 680 V								
FFLC6A8807K--	8800	240 (9.449)	170 (6.693)	220	40	0.58	1.2	18
FFLC6A7157K--	7150	240 (9.449)	145 (5.709)	230	38	0.50	1.2	13.2
FFLC6A6507K--	6500	240 (9.449)	145 (5.709)	210	38	0.55	1.3	15.5
FFLC6A5607K--	5600	170 (6.693)	170 (6.693)	140	35	0.88	1.8	15.5
FFLC6A4557K--	4550	170 (6.693)	145 (5.709)	150	30	0.77	1.8	11.3
FFLC6A4187K--	4180	240 (9.449)	95 (3.740)	300	35	0.34	1.0	10.3
FFLC6A2667K--	2660	170 (6.693)	95 (3.740)	170	28	0.49	1.6	7.3
U_N dc: 1000 V								
FFLC6L5067K--	5060	240 (9.449)	170 (6.693)	250	40	0.61	1.2	17.2
FFLC6L3207K--	3200	170 (6.693)	170 (6.693)	150	35	0.89	1.9	12.4
FFLC6L4307K--	4300	240 (9.449)	145 (5.709)	300	38	0.52	1.1	15.5
FFLC6L2737K--	2730	170 (6.693)	145 (5.709)	170	30	0.75	1.6	11.3
FFLC6L2537K--	2530	240 (9.449)	95 (3.740)	300	35	0.36	0.8	10.3
FFLC6L1607K--	1600	170 (6.693)	95 (3.740)	170	28	0.51	1.2	7.3
U_N dc : 1200 V								
FFLC6U3527K--	3520	240 (9.449)	170 (6.693)	250	40	0.71	1.2	18.8
FFLC6U2247K--	2240	170 (6.693)	170 (6.693)	150	35	1.1	1.9	12.7
FFLC6U3007K--	3000	240 (9.449)	145 (5.709)	300	38	0.60	1.1	15.5
FFLC6U1907K--	1900	170 (6.693)	145 (5.709)	170	30	0.87	1.6	11.3
FFLC6U1757K--	1750	240 (9.449)	95 (3.740)	300	35	0.41	0.8	10.3
FFLC6U1127K--	1120	170 (6.693)	95 (3.740)	170	28	0.59	1.2	7.3

*Very low stray inductance for high frequency applications on request.

LIFETIME EXPECTANCY vs HOT SPOT TEMPERATURE AND VOLTAGE

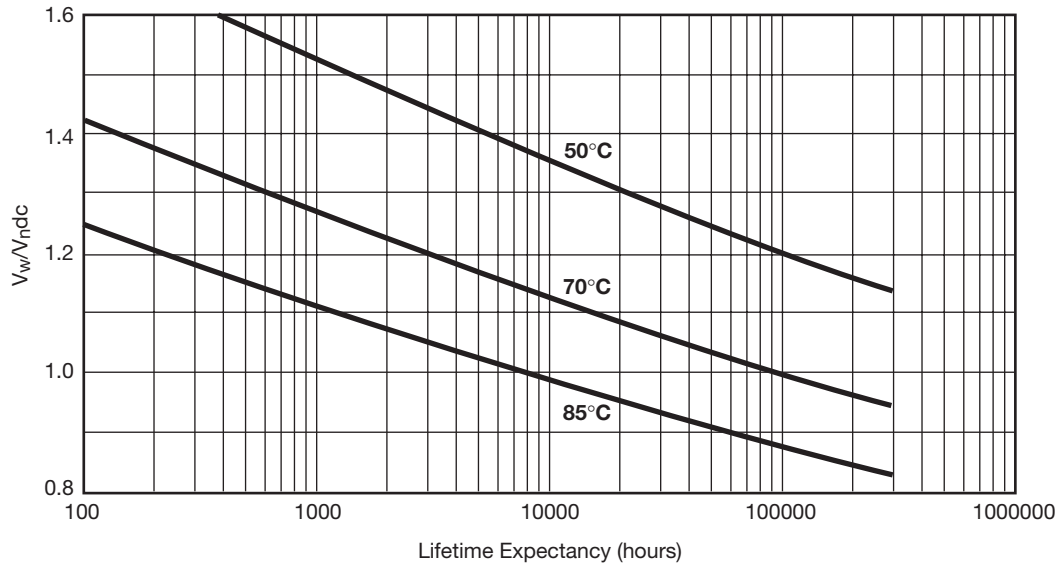

V_w: permanent working or operating DC-voltage.

ELECTRICAL CHARACTERISTICS

Climatic category 40/85/56 (IEC 60068)

FFLC overvoltage: (V_s): V_s = 2 V_{Ndc} and limited at 2100V

Maximum overvoltage	Peak value	Maximum duration
	1.67 V _{Ndc}	100 ms 1 time per week
	1.25 V _{Ndc}	100 ms 1 time per day
	1.1 V _{Ndc}	1 min 1 time per day

Test voltage between terminals @ 25°C
1.5 x V_{Ndc} for 10s

Test voltage between terminals and case @ 25°C
@ 4 kVrms @ 50 Hz for 1 min.

STANDARDS

- IEC 61071-1: Power electronic capacitors
- IEC 61071-2: Power electronic capacitors
- IEC 60068-1: Environmental testing
 - IEC 60077: Rules for electric traction equipment
 - UL 94: Fire requirements
- NF F 16-101
- NF F 16-102: Fire and smoke requirements
- IEC 61881: Railway applications, rolling stock equipment, capacitors for power electronics

HOT SPOT CALCULATION

$$\theta_{\text{hot spot}} = \theta_{\text{ambient}} + (P_d + P_t) \times R_{th}$$

with P_d (Dielectric losses) = $Q \times \text{tg}\delta_0$
 $\Rightarrow [\frac{1}{2} \times C_n \times (V_{\text{peak to peak}})^2 \times f] \times (2 \times 10^{-4})$

$$P_t \text{ (Thermal losses)} = R_s \times (I_{rms})^2$$

where C_n in Farad I_{rms} in Ampere f in Hertz
 V in Volt R_s in Ohm θ in °C
 R_{th} in °C/W

Medium Power Film Capacitors



FSM – New design can use FFV range

DC FILTERING



APPLICATIONS

Recovery capacitor for G.T.O. switching (secondary snubber or clamp capacitor).
High current DC filtering.

TECHNOLOGY

Metallized polypropylene dielectric specially treated to withstand high DC voltage stresses up to 85°C.

Controlled self-healing.

Internal geometry and connections specially developed for high currents (I_{rms} up to 100 A).

No liquid impregnant.

Special metallization for DC voltage and high currents.

PACKAGING

Self-extinguishing rectangular plastic case (in accordance with UL 94 VO) (12 kV/50 Hz isolation).

Filled with thermosetting resin.

M8 outputs.

Fixing in two planes.

Vibrations and shocks resistant to IEC 60077.

Average weight 0.95 kg.

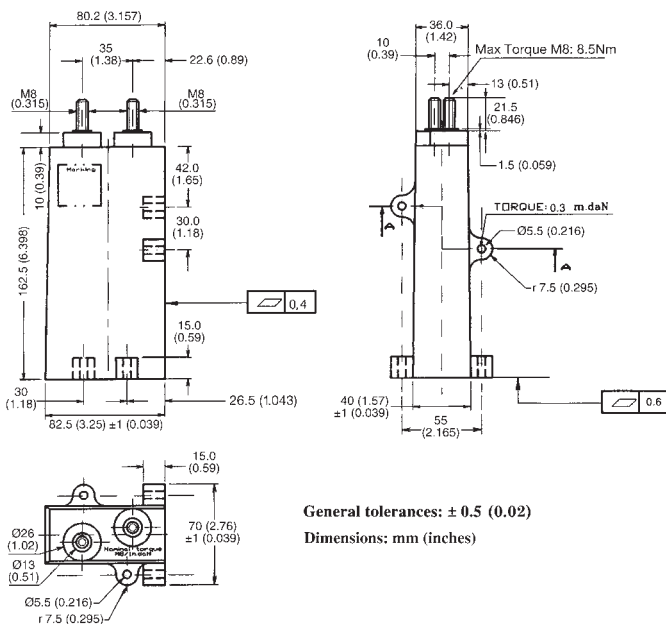

ELECTRICAL CHARACTERISTICS

Climatic category	40/085/56
Working temperature	-40°C to +85°C (according to the power to be dissipated)
Capacitance range C _n	20µF to 54µF
Tolerance on C _n	±10%
Rated DC voltage V _{ndc}	750 to 1350 V
Allowable overvoltages	V _s = 1.1 V _{ndc} – 1/3 of the time 1.3 V _{ndc} – 1 min./day 2 V _{ndc} – 100 ms/day for V _{ndc} ≤ 1150 V 1.75 V _{ndc} – 100 ms/day for V _{ndc} = 1350 V
DC test voltage between 10s at 20°C ± 15°C terminals	V _{edc} – 1.5 V _{ndc} (IEC 61071)
RMS current	I _{rms} max. = 65 to 105 A
Impulse current	I _{2.t} max. = 100 to 270 A ² s
Tangent of loss angle	Tgδ: see table of values
Series inductance L _s	≤ 25 nH
Thermal resistance	R _{th} ambient/hot spot = 9.2°C/W R _{th} case/hot spot = 3.3°C/W

MARKING

Logo TPC

FSM

Capacitance and tolerance in clear

Nominal voltage in clear

RMS current in clear

Date of manufacture (IEC coding)



1) RECOVERY OF G.T.O. SWITCHING ENERGY

Typical application

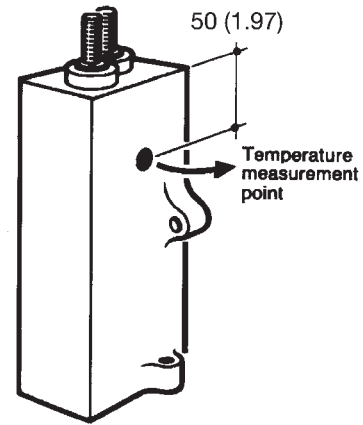
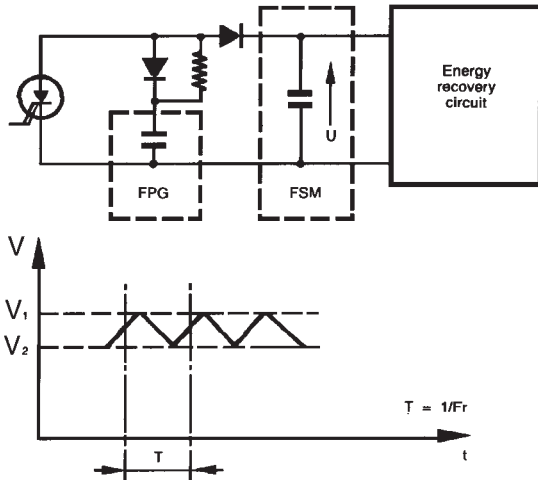

Choice of voltage:

$$V_1 \leq V_{n,dc}$$

Repetitive surge:

$$1.1 V_{n,dc} - 1/3 \text{ of the time}$$

Non-repetitive surge:

$$1.3 V_{n,dc} - 1 \text{ min./day}$$

Occasional max. surge:

$$2 V_{n,dc} - 100 \text{ ms/day for } V_{n,dc} \leq 1150 \text{ V}$$

$$1.75 V_{n,dc} - 100 \text{ ms/day for } V_{n,dc} = 1350 \text{ V}$$

RMS current limits:

The currents given in the tables are maximum. The thermal limits of the dielectric (85°C) must be respected.

The self-heating can be calculated from the series resistance, $Tg\delta$ and the thermal resistance given in the table of values

$$\Delta\theta = P \times R_{th} \leq 85^\circ\text{C} - \theta_{\text{ambient}}$$

R_{th} : is given for still air with the capacitor not being subjected to any other heat source.

$$P = (I_{rms})^2 \times R_s + \frac{\pi}{2} \times C (V_1 - V_2)^2 \times f_r \times 10^{-4}$$

Temperature measuring point*

Measurement of the case temperature (θ_B) together with the losses gives the temperature of the hot spot.

$$\theta = (R_{thB} \times P) + \theta_B \leq 85^\circ\text{C}$$

*Important for series/parallel operations.

Important

Due to the modular nature of these capacitors series and parallel assemblies can be made to increase the capacitance and/or voltage.

Ensure that suitable sized connections are used so that the capacitors will not be overheated. The inductance of the connections must be low enough to ensure equal current sharing of capacitors in parallel.

For series assemblies, connect across each capacitor a resistor of value

$$R \# 30 \text{ M}\Omega/\text{C in } \mu\text{F} \\ (1.5 \text{ M}\Omega \text{ for } C = 20 \mu\text{F}).$$

2) DC FILTERING

Idem paragraph 1.

Cn (μF)	Vn,dc (V)	Irms* maxi.* (A)	(I ² .t) max. (A ² .s)	Tgδ (f→kHz) (10 ⁻⁴)	Rs (mΩ)	References
54	750	105	270	2 + 3.4 f	1	FSM26A0546K--
42	900	100	220	2 + 2.8 f	1.05	FSM26C0446K--
33	1000	95	170	2 + 2.3 f	1.1	FSM26L0336K--
28	1150	85	150	2 + 2 f	1.15	FSM26U0286K--
20	1350	65	100	2 + 1.6 f	1.25	FSM26V0206K--

Table of Values

*Function of power dissipation

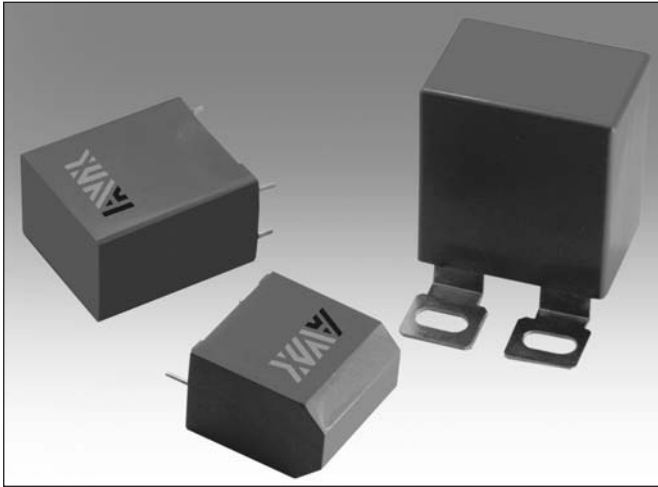

GENERAL DESCRIPTION

Metallized polypropylene dielectric capacitor with controlled self-healing.

Reinforced metallization developed for high impulse currents.

APPLICATIONS

- IGBT protection
- IGBT clamping

PACKAGING

- Parallelepipedic plastic case with thermosetting resin

ELECTRICAL CHARACTERISTICS

Capacitance Range C_n	0.10 μ F to 2.5 μ F
Tolerance on C_n	$\pm 5\%$: FSB1...5 $\pm 10\%$: FSB6
Rated DC Voltage V_{ndc}	850 to 2000 V
Stray Inductance	≤ 25 nH
RMS Current	I_{rms} max. = up to 28A The currents shown in the tables are maximum. It is necessary to respect the thermal limits of the dielectric 85°C see "Hot spot temperature calculation"
Insulation Resistance	$R_i \times C \geq 30,000$ s
Impulse Current	$I^2.t$ max. = up to 1.69 A ² s Spikes or peak currents in the capacitors may cause a deterioration of the bonding between the metallization and the connections. These bonds are capable of withstanding only a limited amount of energy for each spike. The table shows the maximum energy permitted in the form ($I^2.t$), where I is in Ampere, and t is in seconds.
Note: The formula ($I^2.t$) replaces dv/dt which is less easy to use as it is not an expression of energy ($I = C.dv/dt$). This type of capacitor has been designed to withstand high ($I^2.t$) values.	
Variation of Capacitance with Temperature	$\frac{\Delta C}{C} \leq \pm 2\%$ between -40 and +85°C
Climatic Category	40/085/56 (IEC 68)
Test Voltage Between Terminals @ 25°C	1.6 V_{ndc} during 10s
Withstanding Voltage Between Terminals and Case @ 25°C	@ 3 kVrms @ 50Hz during 1 min.

Medium Power Film Capacitors



FSB

GENERAL DESCRIPTION

BOX KIND: P0; 18; 19; 26; R68 FSB1..5
2 TERMINALS SOLUTION

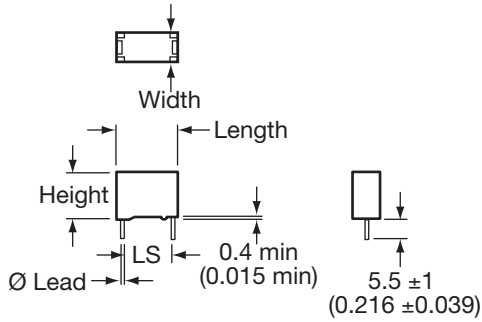

General Tolerance: ±0.5mm (0.020)

BOX KIND: R68 FSB5
4 TERMINALS SOLUTION

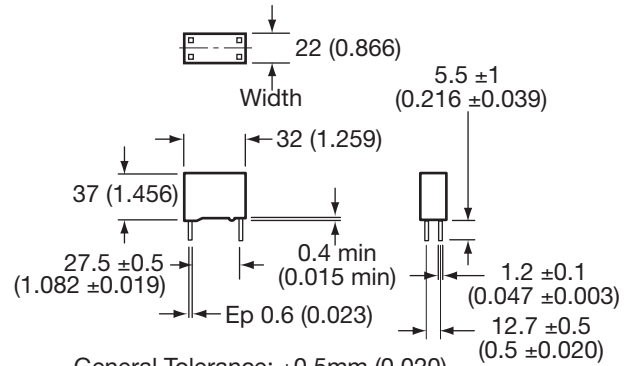

General Tolerance: ±0.5mm (0.020)

PROTECTION

DIMENSIONS: millimeters (inches)

Box Kind	Length mm ±0.40 (inches)	Width mm ±0.40 (inches)	Height mm ±0.30 (inches)	Dimensions lead mm (inches)	LS mm ±0.40 (inches)
PO	31.1 (1.230)	13.0 (0.051)	22.4 (0.880)	Ø 0.80 (0.031)	27.5 (1.083)
18	31.1 (1.230)	14.6 (0.580)	25.7 (1.010)	Ø 0.80 (0.031)	27.5 (1.083)
19	31.1 (1.230)	17.3 (0.068)	29.8 (1.170)	Ø 0.80 (0.031)	27.5 (1.083)
26	31.1 (1.230)	20.8 (0.820)	31.3 (1.230)	Ø 1.00 (0.039)	27.5 (1.083)
R68 2 Terminals Solution	32.5 (1.280)	22.0 (0.870)	37.0 (1.460)	Ø 1.00 (0.039)	27.5 (1.083)
R68 4 Terminals Solution	32.5 (1.280)	22.0 (0.870)	37.0 (1.460)	1.20 x 0.60 (0.047 x 0.023)	27.5 (1.083)

References	Capacitance (µF)	Box Kind	(I²t) (A²s)	I _{rms} (A)	R _s (mΩ)	R _{th} (hotspot/amb.)
U_Ndc = 1200V		V_{peak} = 1600V		V_{rms} = 560V		V_s = 2000V
FSB16U0154J--	0.15	P0	0.05	3	14.3	45.9
FSB26U0274J--	0.27	18	0.15	7.6	8.4	36.8
FSB36U0394J--	0.39	19	0.31	11	6.2	32.2
FSB46U0474J--	0.47	26	0.41	12	5.6	29.4
FSB56U0684J--	0.68	R68 (2 terminals)	0.94	12	3.8	23.7
FSB56U0684JJC	0.68	R68 (4 terminals)	0.94	16.7	3.8	23.7
U_Ndc = 1600V		V_{peak} = 2000V		V_{rms} = 630V		V_s = 2300V
FSB16M0134J--	0.13	P0	0.05	4.6	13.3	44.9
FSB26M0184J--	0.18	18	0.1	6.4	9.9	35.9
FSB36M0244J--	0.24	19	0.18	8.5	7.8	32.4
FSB46M0334J--	0.33	26	0.35	11.7	5.6	28.6
FSB56M0434J--	0.43	R68 (2 terminals)	0.59	12	4.6	23.8
FSB56M0434JJC	0.43	R68 (4 terminals)	0.59	15.2	4.6	23.8
U_Ndc = 2000V		V_{peak} = 2400V		V_{rms} = 700V		V_s = 2600V
FSB16N0104J--	0.1	P0	0.05	4.2	14.3	44.6
FSB26N0134J--	0.13	18	0.08	5.5	11.3	35.7
FSB36N0184J--	0.18	19	0.15	7.6	8.5	32.1
FSB46N0224J--	0.22	26	0.22	9.3	6.8	29.1
FSB56N0304J--	0.3	R68 (2 terminals)	0.41	12	5.3	23.8
FSB56N0304JJC	0.3	R68 (4 terminals)	0.41	12.7	5.3	23.8



Medium Power Film Capacitors



FSB

FSB6

Plastic case resin filled
Dimensions: millimeters (inches)

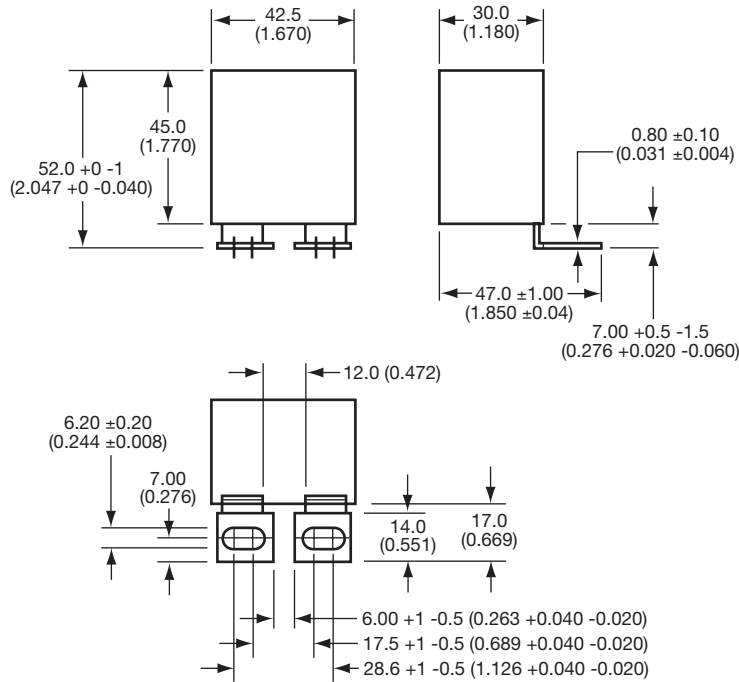

GENERAL TOLERANCES: ±0.50mm (±0.020 inches)

PROTECTION

Part Number	Capacitance (μF)	(I ² t) (A ² s)	I _{rms max.} (A)	R _s (mΩ)	R _{th} (°C/W)
FSB 850V	V_{ndc} = 850V	V_{peak} = 1200V	V_{rms} = 450V	V_s = 1500V	
FSB66B0205K--	2	0.99	25	3.4	19.1
FSB66B0225K--	2.2	1.19	28	3.1	18.6
FSB66B0255K--	2.5	1.54	28	2.7	17.8
FSB 1200V	V_{ndc} = 1200V	V_{peak} = 1600V	V_{rms} = 560V	V_s = 2000V	
FSB66U0105K--	1	1.47	25	3.6	17.2
FSB66U0125K--	1.2	1.69	26	3.4	17.5
FSB66U0155K--	1.5	1	26	3.4	17.5
FSB 2000V	V_{ndc} = 2000V	V_{peak} = 2400V	V_{rms} = 700V	V_s = 2600V	
FSB66N0474K--	0.47	0.41	22	6.3	19.4
FSB66N0564K--	0.56	0.62	23	5.2	17.9
FSB66N0684K--	0.68	0.91	24	4.4	17.3

STANDARDS

IEC 61071-1, IEC 61071-2: Power electronic capacitors

TANGENT OF LOSS ANGLE (TANδ₀) FOR POLYPROPYLENE DIELECTRIC

Polypropylene has a constant dielectric loss factor of 2x10⁻⁴ irrespective of temperature and frequency (up to 1 MHz).

IGBT SNUBBER

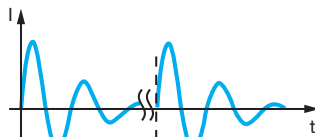
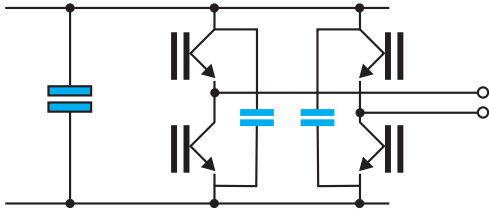

With

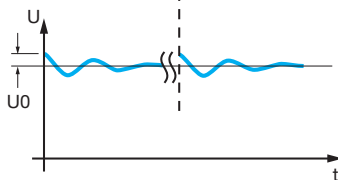

L = stray inductance IGBT + capacitor

R = serial resistance IGBT + capacitor

HOT SPOT TEMPERATURE CALCULATION

$$\theta_{\text{hot spot}} = \theta_{\text{ambient}} + (P_d + P_t) \times R_{\text{th}}$$

with P_d (Dielectric losses) = $Q \times \text{tg}\delta_0$
 $\Rightarrow [\frac{1}{2} \times C_n \times (V_{\text{ripple peak to peak}})^2 \times f] \times (2 \times 10^{-4})$
 P_t (Thermal losses) = $R_s \times (I_{\text{rms}})^2$
 R_{th} : $R_{\text{th ambient / hot spot}}$ in °C/W

where C_n in Farad I_{rms} in Ampere f in Hertz
 V in Volt R_s in Ohm θ in °C

Due to the design of the capacitor and its technology, the thermal impedance between the terminations and the core of the capacitor is low, it is necessary to take care that the capacitor is never overheated by use of wrongly sized connections.

Do not use the capacitor as a heat sink.

Due to the complexity of the IGBT / capacitor thermal exchanges, we recommend that thermal measurements shall be made on the different components. We would be pleased to advise you on specific problems.

WORKING TEMPERATURE

(according to the power to be dissipated) -40°C to +85°C

MARKING

- TPC logo
- Capacitance and tolerance in clear
- Nominal DC voltage in clear
- RMS current in clear
- Date of manufacture (IEC coding)

$$I_{\text{eff}} = \sqrt{\left[\frac{C\beta_0^2 \times U_0}{2j\beta} \right]^2 \times \frac{1}{T} \times \left[\frac{e^{-2\alpha \times T}}{\beta^2 + \alpha^2} \times [\beta \sin(2\beta \times T) - \alpha \times \cos(2\beta \times T)] + \frac{1}{\alpha} \times e^{-2\alpha \times T} + \frac{\alpha}{\beta^2 + \alpha^2} - \frac{1}{\alpha} \right]}$$

with $\beta_0 = \sqrt{\frac{1}{LC}}$; $\alpha = \frac{R}{2L}$; $\beta = \sqrt{\beta_0^2 - \alpha^2}$

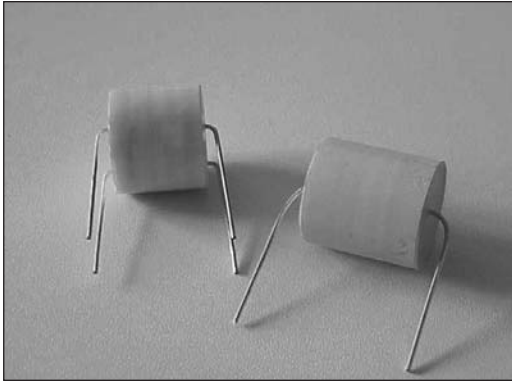

GENERAL DESCRIPTION

Metallized dielectric capacitor and metal foil, low serial inductance and high RMS current.

APPLICATIONS

- Protection of semi conductors
- High frequency decoupling
- Tuning

PACKAGING

- Cylindrical with polyester tape wrapping, sealed with polyurethane resin
- Radial connections

ELECTRICAL CHARACTERISTICS

Capacitance Range Cn	0.010μF to 0.15μF
Tolerance on Cn	10%
Rated DC Voltage Vndc	600 to 2000 V
Rated AC Voltage	300 to 650 Vrms
Test Voltage between terminals @ 25°C	1.5 Vndc during 10s
High dV/dt	10000 V/μs
RMS Current	Irms max = up to 23A The currents shown in the tables are maximum. It is necessary to respect the thermal limits of the dielectric 85°C See "Hot spot temperature calculation"
Working Temperature	-40°C +85°C (according to the power to be dissipated)
Climatic Category	40/085/56 (IEC 60068)
Hot Spot Calculation	For all applications, the temperature in the hot spot capacitor must be lower than 85°C $\Theta_{\text{Hot spot}} = \Theta_{\text{ambient}} + (\tan\delta_o \times Q + R_s I_{\text{rms}}^2) \times R_{\text{th}}$ With $\tan\delta_o = 2 \cdot 10^{-4}$ Q in vars R_s in Ω I_{rms} in A R_{th} in °C/W

Medium Power Film Capacitors



FSV

DESIGN

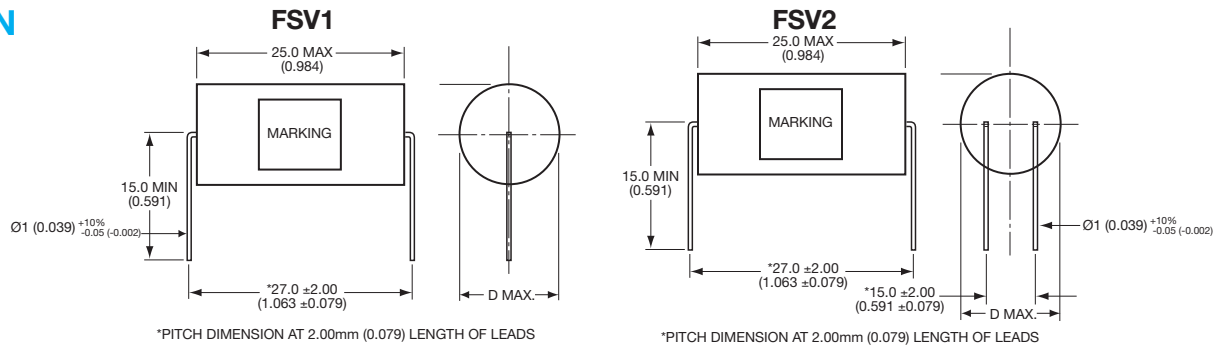

PROTECTION

References	Capacitance (µF)	D max. mm (in)	Irms A	Rs (mΩ)	Rth °C/W
FSV 600 V Vndc = 600V Vrms = 300V					
FSV16K0683K--	0.068	22 (0.866)	10	2.5	35
FSV26K0104K--	0.10	25 (0.984)	15	2.1	25
FSV26K0154K--	0.15	30 (1.181)	23	1.8	17
FSV 800 V Vndc = 800V Vrms = 400V					
FSV16B0473K--	0.047	22 (0.866)	10	2.6	33
FSV26B0683K--	0.068	25 (0.984)	15	2.2	23
FSV26B0823K--	0.082	28 (1.102)	18	2.1	21
FSV26B0104K--	0.100	30 (1.181)	23	1.9	16
FSV 1000 V Vndc = 1000V Vrms = 450V					
FSV16L0333K--	0.033	22 (0.866)	8	2.8	31
FSV26L0473K--	0.047	25 (0.984)	12	2.3	22
FSV26L0683K--	0.068	30 (1.181)	17	2.0	16
FSV 1200 V Vndc = 1200V Vrms = 500V					
FSV16U0223K--	0.022	22 (0.866)	7	3.2	34
FSV26U0333K--	0.033	25 (0.984)	10	2.2	23
FSV26U0473K--	0.047	30 (1.181)	14	2.1	16
FSV 1500 V Vndc = 1500V Vrms = 600V					
FSV16R0153K--	0.015	22 (0.866)	5	3.5	34
FSV26R0223K-	0.022	25 (0.984)	8	2.8	22
FSV26R0333K-	0.033	30 (1.181)	12	2.2	16
FSV 2000 V Vndc = 2000V Vrms = 650V					
FSV16N0103K--	0.010	22 (0.866)	5	3.4	34
FSV26N0153K--	0.015	25 (0.984)	7	2.9	21
FSV26N0203K--	0.020	27 (1.063)	10	2.4	16
FSV26N0223K--	0.022	30 (1.181)	11	2.4	14

Medium Power Film Capacitors



FPX

PROTECTION



APPLICATIONS

Protection of thyristors.
Protection of gate turn-off thyristor (G.T.O.).
Clamping (Secondary snubber).

TECHNOLOGY

Metallized polypropylene dielectric capacitor with controlled self-healing.
Reinforced metallization developed for high impulse currents.
Axial connections specially developed to reduce series inductance and to provide rigid mechanical mounting.

PACKAGING

Cylindrical in plastic case filled with thermosetting resin.
Outputs: threaded inserts either M6 or M8.

PROTECTION

ELECTRICAL CHARACTERISTICS

Capacitance range C_n	0.5 μ F to 6 μ F
Tolerance on C_n	$\pm 5\%$
Rated DC voltage V_{ndc}	1000 to 3000 V
Peak voltage V_{peak}	1600 to 4000 V
Allowable overvoltage V_s (for 10 s/day)	2000 to 4600 V
Stray inductance	5 to 20 nH
RMS current	I_{rms} max. = up to 160 A The currents shown in the tables are maximum. It is necessary to respect the thermal limits of the dielectric 85°C see "Hot spot temperature calculation"
Insulation resistance	$R_i \times C \geq 30,000$ s
Impulse current	$I^2.t$ maxi. = up to 729 A ² .s Spikes or peak currents in the capacitors may cause a deterioration of the bonding between the metallization and the connections. These bonds are capable of withstanding only a limited amount of energy for each spike. The table shows the maximum energy permitted in the form ($I^2.t$), where I is in Ampere, and t is in seconds.
Note: The formula ($I^2.t$) replaces dV/dt which is less easy to use as it is not an expression of energy ($I = C.dV/dt$). This type of capacitor has been designed to withstand high ($I^2.t$) values.	
Variation of capacitance with temperature	$\frac{\Delta C}{C} \leq \pm 2\%$ between -40 and 85°C
Climatic category	40/085/56 (IEC 60068)
Test voltage between terminals @ 25°C	V_s for 10s
Test voltage between terminals and case @ 25°C (Type test)	@ 4 kVrms @ 50 Hz for 1 min.

For higher power protection devices and further information please see PPX Series in Capacitor for High Power Electronics available on AVX website: www.avxcorp.com



PROTECTION

PROTECTION

G.T.O.

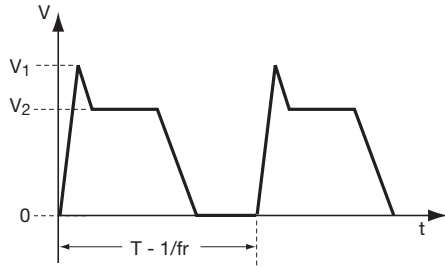

Choice of voltage: $V_1 \leq V_{peak}$
 $V_2 \leq V_{ndc}$

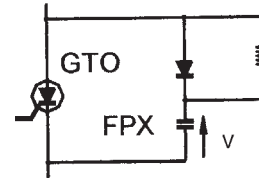

Nominal DC voltage (V_{ndc}) and peak voltage (V_{peak}) are given in the tables.

THYRISTOR

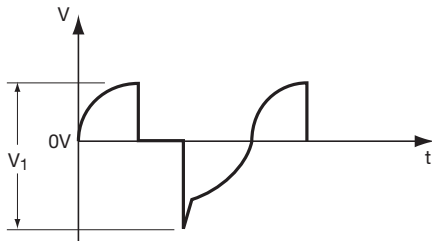

Choice of voltage: $V_1 \leq V_{peak}$

Note that V_1 is the voltage peak to peak and cannot be symmetrical vs 0 V

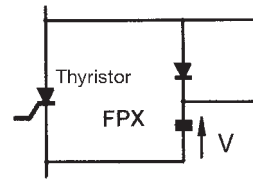

Peak voltage is given in the tables.

CLAMPING

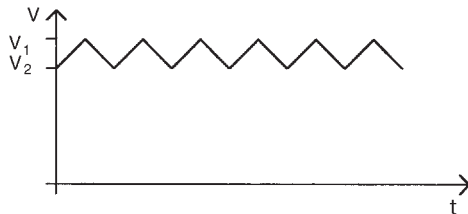

Choice of voltage: $V_1 \leq V_{peak}$
 $V_2 \leq V_{ndc}$

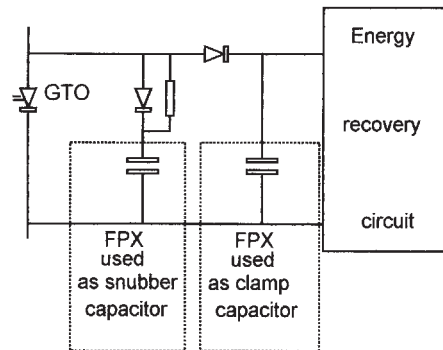

Nominal DC voltage (V_{ndc}) and peak voltage (V_{peak}) are given in the tables.

Medium Power Film Capacitors



FPX Table of Values

PROTECTION

Dimensions: millimeters (inches)

Cn (μ F)	Case Type	Dimensions				$I^2.t$ max. (A ² .s)	I_{rms} max. (A)	R_s (m Ω)	R_{th} ($^{\circ}$ C/W)	Part Number
		H* ± 0.5 (± 0.020)	h ± 2 (± 0.079)	D max.	d ± 0.1					
FPX 2000 V										
		$V_{Ndc} = 1000 V$		$V_{peak} = 1600 V$		$V_{rms} = 560 V$		$V_s = 2000 V$		
1	Plastic case M6/6	52 (2.072)	5 (0.197)	40 (1.575)	18 (0.709)	2	15	2.4	14	FPX66N0105J--
2	Plastic case M8/8	52 (2.072)	5 (0.197)	60 (2.362)	22 (0.866)	8	30	1.2	6.1	FPX86N0205J--
3	Plastic case M8/8	52 (2.072)	5 (0.197)	72 (2.835)	22 (0.866)	18	45	0.9	4.5	FPX86N0305J--
3.5	Plastic case M8/8	52 (2.072)	5 (0.197)	72 (2.835)	22 (0.866)	25	50	0.85	4.5	FPX86N0355J--
4	Plastic case M8/8	52 (2.072)	5 (0.197)	82 (3.228)	22 (0.866)	32	60	0.75	3.5	FPX86N0405J--
5	Plastic case M8/8	52 (2.072)	5 (0.197)	82 (3.228)	22 (0.866)	50	70	0.65	2.5	FPX86N0505J--
FPX 2500 V										
		$V_{Ndc} = 1300 V$		$V_{peak} = 2000 V$		$V_{rms} = 700 V$		$V_s = 2500 V$		
0.5	Plastic case M6/6	52 (2.072)	5 (0.197)	40 (1.575)	18 (0.709)	1	15	3	14	FPX66P0504J--
1	Plastic case M8/8	52 (2.072)	5 (0.197)	60 (2.362)	22 (0.866)	3	20	2.3	10.5	FPX86P0105J--
1.5	Plastic case M8/8	52 (2.072)	5 (0.197)	60 (2.362)	22 (0.866)	7	30	1.5	6.1	FPX86P0155J--
2	Plastic case M8/8	52 (2.072)	5 (0.197)	72 (2.835)	22 (0.866)	12.7	40	1.1	4.5	FPX86P0205J--
2.5	Plastic case M8/8	52 (2.072)	5 (0.197)	72 (2.835)	22 (0.866)	20	60	0.89	3.7	FPX86P0255J--
3	Plastic case M8/8	52 (2.072)	5 (0.197)	82 (3.228)	22 (0.866)	28	60	0.85	3.2	FPX86P0305J--
3.5	Plastic case M8/8	52 (2.072)	5 (0.197)	82 (3.228)	22 (0.866)	39	65	0.78	2.9	FPX86P0355J--
FPX 3500 V										
		$V_{Ndc} = 2000 V$		$V_{peak} = 2400 V$		$V_{rms} = 850 V$		$V_s = 3500 V$		
2	Plastic case M8/8	62 (2.441)	5 (0.197)	72 (2.835)	22 (0.866)	23	41	1.24	6.1	FPX86X0205J-
3	Plastic case M8/8	62 (2.441)	5 (0.197)	92 (3.622)	22 (0.866)	50	62	0.92	3.9	FPX86X0305J--
3.5	Plastic case M8/8	62 (2.441)	5 (0.197)	92 (3.622)	22 (0.866)	70	72	0.83	3.4	FPX86X0355J--
4	Plastic case M8/8	62 (2.441)	5 (0.197)	92 (3.622)	22 (0.866)	85	80	0.78	3.1	FPX86X0405J--
FPX 4500 V										
		$V_{Ndc} = 2500 V$		$V_{peak} = 3200 V$		$V_{rms} = 1130 V$		$V_s = 4500 V$		
0.9	Plastic case M8/8	62 (2.441)	5 (0.197)	72 (2.835)	22 (0.866)	15	40	1.5	6.2	FPX86Z0904J--
1	Plastic case M8/8	62 (2.441)	5 (0.197)	72 (2.835)	22 (0.866)	15	38	1.4	6.2	FPX86Z0105J--
2	Plastic case M8/8	62 (2.441)	5 (0.197)	92 (3.622)	22 (0.866)	70	75	0.85	3.1	FPX86Z0205J--
FPX 4600 V										
		$V_{Ndc} = 3000 V$		$V_{peak} = 4000 V$		$V_{rms} = 1400 V$		$V_s = 4600 V$		
0.5	Plastic case M8/8	62 (2.441)	5 (0.197)	72 (2.835)	22 (0.866)	7	40	1.7	12	FPX86Y0504J--
0.68	Plastic case M8/8	62 (2.441)	5 (0.197)	72 (2.835)	22 (0.866)	14	35	1.59	6.2	FPX86Y0684J--
1.25	Plastic case M8/8	62 (2.441)	5 (0.197)	92 (3.622)	22 (0.866)	50	65	1	3.3	FPX86Y1254J--
1.5	Plastic case M8/10	79 (3.110)	6 (0.236)	98 (3.858)	-	32	60	1.4	8.3	FPX86Y0155J--
1.7	Plastic case M8/10	79 (3.110)	6 (0.236)	98 (3.858)	-	40	70	1.3	7.4	FPX86Y0175J--
2	Plastic case M8/10	79 (3.110)	6 (0.236)	98 (3.858)	-	56	80	1.1	6.3	FPX86Y0205J--
2.5	Plastic case M8/10	118 (4.646)	6 (0.236)	98 (3.858)	-	200	130	0.8	1.1	FPX86Y0255J--
2.7	Plastic case M8/10	118 (4.646)	6 (0.236)	98 (3.858)	-	232	140	0.7	1.1	FPX86Y0275J--
3	Plastic case M8/10	143 (5.630)	6 (0.236)	98 (3.858)	-	128	100	0.9	1.5	FPX86Y0305J--
3.5	Plastic case M8/10	143 (5.630)	6 (0.236)	98 (3.858)	-	170	110	0.8	1.4	FPX86Y0355J--
4	Plastic case M8/10	143 (5.630)	6 (0.236)	98 (3.858)	-	224	115	0.8	1.4	FPX86Y0405J--
4.5	Plastic case M8/10	163 (6.417)	6 (0.236)	98 (3.858)	-	522	120	0.6	1.7	FPX86Y0455J--
5	Plastic case M8/10	163 (6.417)	6 (0.236)	98 (3.858)	-	600	130	0.6	1.7	FPX86Y0505J--
6	Plastic case M8/10	163 (6.417)	6 (0.236)	98 (3.858)	-	729	160	0.5	1.7	FPX86Y0605J--

* Tol: +0 / -3mm for H \geq 118mm

PROTECTION

For higher power protection devices and further information please see PPX Series in Capacitor for High Power Electronics available on AVX website: www.avxcorp.com



PROTECTION MARKING

Logo	Nominal DC voltage in clear
Withstanding surge voltage	RMS current in clear
Capacitance and tolerance in clear	Date of manufacture (IEC coding)

DESIGN

Plastic Case M6 / 6 or M8 / 8

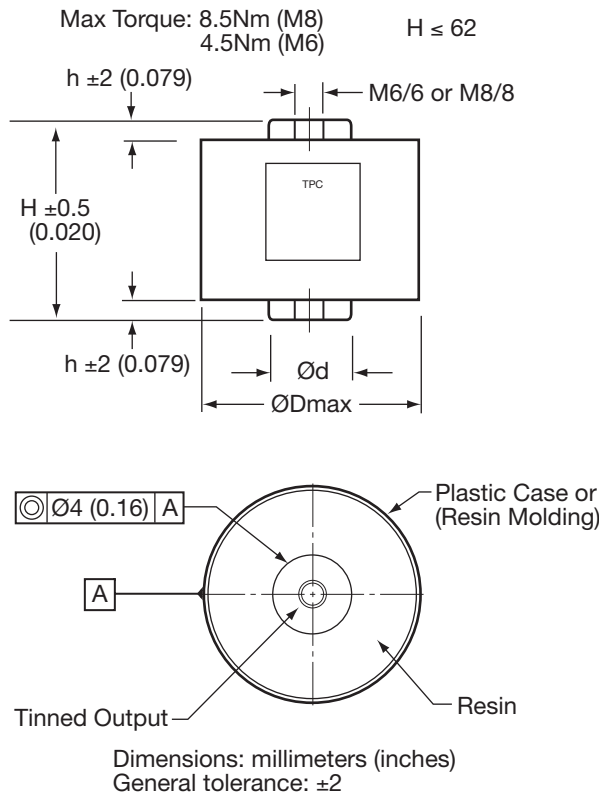

Plastic Case M8 / 10

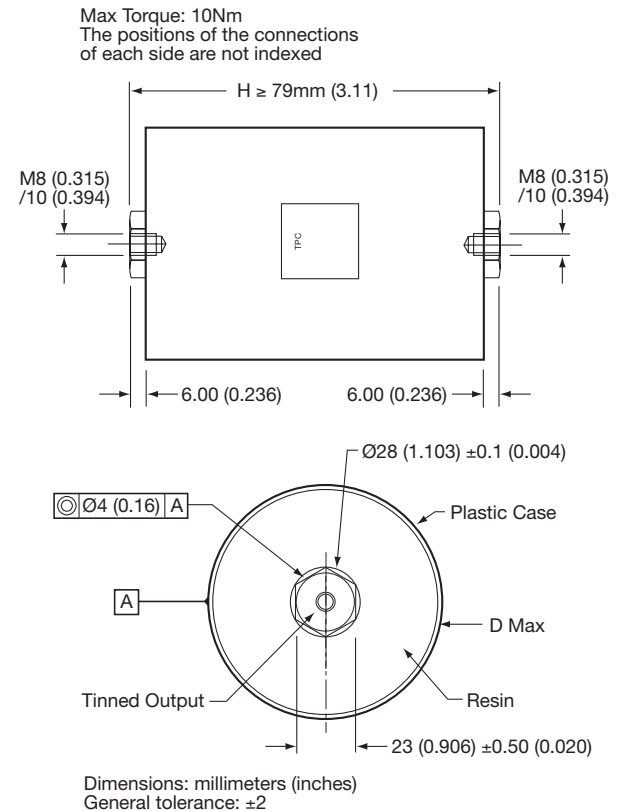

PROTECTION

HOT SPOT TEMPERATURE CALCULATION

$$\theta_{\text{hot spot}} = \theta_{\text{terminals}} + (P_d + P_t) \times R_{\text{th}}$$

with

$$P_d \text{ (Dielectric losses)} = Q \times \text{tg}\delta_0$$

$$\Rightarrow \left[\frac{1}{2} \times C_n \times (V_{\text{peak to peak}})^2 \times f \right] \times (2 \times 10^{-4})$$

$$P_t \text{ (Thermal losses)} = R_s \times (I_{\text{rms}})^2$$

where

- C_n in Farads
- V in Volts
- I_{rms} in Amperes
- R_s in Ohms
- f in Hertz
- θ in $^{\circ}\text{C}$
- R_{th} in $^{\circ}\text{C}/\text{W}$

Due to the design of the capacitor and its technology, the thermal impedance between the terminations and the core of the capacitor is low, it is necessary to take care that the capacitor is never overheated by use of incorrect sized connections.

In the case where the series diodes are screwed to the capacitor, cooling of the diodes must be taken in account.

Do not use the capacitor as a heat sink.

Due to the complexity of the diode/capacitor thermal exchanges, we recommend that thermal measurements shall be made on the different components. We would be pleased to advise you on specific problems.

WORKING TEMPERATURE

(according to the power to be dissipated) -40°C to $+85^{\circ}\text{C}$

For higher power protection devices and further information please see PPX Series in Capacitor for High Power Electronics available on AVX website: www.avxcorp.com

Medium Power Film Capacitors



FPG - General Description

PROTECTION



Metallized polypropylene dielectric capacitor with controlled self-healing.

Reinforced metallization on margins developed for high impulse currents.

Axial connections specially developed to reduce series inductance and to provide rigid mechanical mounting.

APPLICATIONS

Protection of gate turn-off thyristor (G.T.O.).

Medium frequency tuning.

PACKAGING

Cylindrical in either plastic case (preferred packaging) or a resin molding.

Outputs: threaded inserts either M6 or M8.

Filled with thermosetting resin.

PROTECTION

ELECTRICAL CHARACTERISTICS

Capacitance range C_n	0.12 μ F to 6 μ F
Tolerance on C_n	$\pm 5\%$
Rated DC voltage $V_{n,dc}$	800 to 3000 V
Peak voltage V_{peak}	1200 to 4000 V
Allowable overvoltage V_s (for 10 s/day)	1500 to 4600 V
Nominal RMS voltage $V_{n,dc}$	500 to 1400 V
Stray inductance	≈ 10 nH
RMS current	I_{rms} max. = up to 80 A The currents shown in the tables are maximum. It is necessary to respect the thermal limits of the dielectric 85°C see "Hot spot temperature calculation"
Insulation resistance	$R_i \times C \geq 30,000$ s
Impulse current	$I^2.t$ max. given in the tables Spikes or peak currents in the capacitors may cause a deterioration of the bonding between the metallization and the connections. These bonds are capable of withstanding only a limited amount of energy for each spike. The table shows the maximum energy permitted in the form ($I^2.t$), where I is in Ampere, and t is in seconds.
Note:	The formula ($I^2.t$) replaces dV/dt which is less easy to use as it is not an expression of energy ($I = C.dV/dt$). This type of capacitor has been designed to withstand high ($I^2.t$) values.
Variation of capacitance with temperature	$\frac{\Delta C}{C} \leq \pm 2\%$ between -40 and 85°C
Climatic category	40/085/56 (IEC 60068)
Test voltage between terminals @ 25°C	V_s during 10s
Test voltage between terminals and case @ 25°C (Type test)	@ 4 kVrms @ 50 Hz during 1 min.

For higher power protection devices and further information please see PPX Series in Capacitor for High Power Electronics available on AVX website: www.avxcorp.com



Medium Power Film Capacitors



FPG General Description / Application Notes

PROTECTION

APPLICATION NOTES

G.T.O. PROTECTION

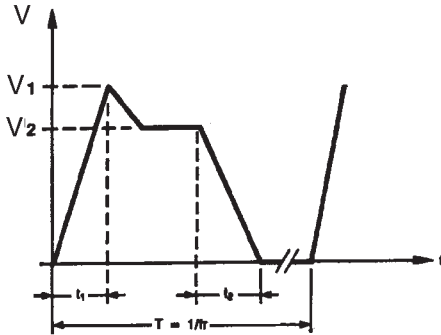

Choice of voltage: $V_1 \leq V_{peak}$
 $V_2 \leq V_{nDC}$
 Maximum overvoltage $\leq V_s$ (10 s/day)

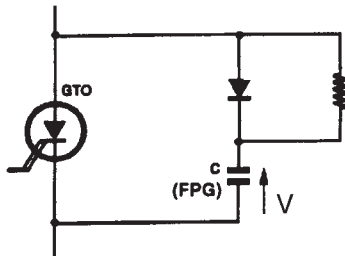

FPG: Snubber capacitor

Nominal DC voltage (V_{nDC}) and peak voltage (V_{peak}) are given in the table of values.

HOT SPOT TEMPERATURE CALCULATION

$$\theta_{hot\ spot} = \theta_{terminals} + (P_d + P_t) \times R_{th}$$

with

$$P_d \text{ (Dielectric losses)} = Q \times \text{tg}\delta_0$$

$$\Rightarrow [\frac{1}{2} \times C_n \times (V_{peak\ to\ peak})^2 \times f] \times (2 \times 10^{-4})$$

$$P_t \text{ (Thermal losses)} = R_s \times (I_{rms})^2$$

where

- C_n in Farads
- V in Volts
- I_{rms} in Amperes
- R_s in Ohms
- f in Hertz
- θ in °C
- R_{th} in °C/W

MARKING

- Logo
- Withstanding surge voltage
- Capacitance and tolerance in clear
- Nominal DC voltage in clear
- RMS current in clear
- Date of manufacture (IEC coding)

DESIGN

Dimensions: millimeters (inches)

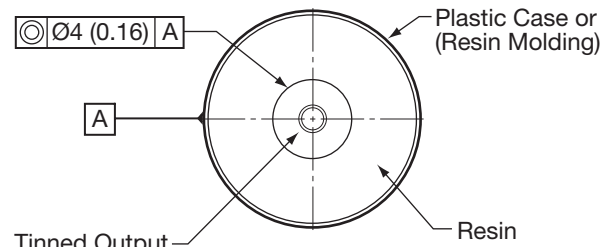
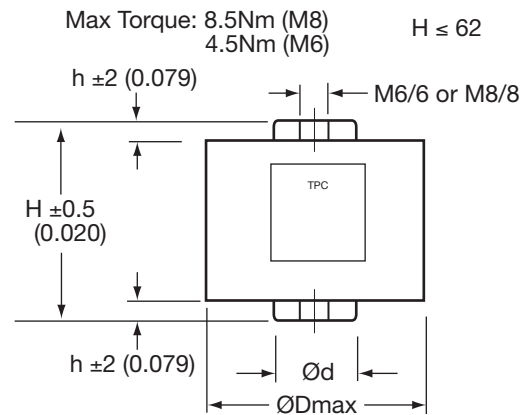

Dimensions: millimeters (inches)
 General tolerance: ± 2

Due to the design of the capacitor and its technology, the thermal impedance between the terminations and the core of the capacitor is low, it is necessary to take care that the capacitor is never overheated by use of incorrect sized connections.

In the case where the series diodes are screwed to the capacitor, cooling of the diodes must be taken in account.

Do not use the capacitor as a heat sink.

Due to the complexity of the diode/capacitor thermal exchanges, we recommend that thermal measurements shall be made on the different components. We would be pleased to advise you on specific problems.

WORKING TEMPERATURE

(according to the power to be dissipated) -40°C to +85°C

For higher power protection devices and further information please see PPX Series in Capacitor for High Power Electronics available on AVX website: www.avxcorp.com

Medium Power Film Capacitors



FPG Table of Values

PROTECTION

Dimensions: millimeters (inches)

Cn (μ F)	Case Type	Dimensions				I ² t max. (A ² .s)	I _{rms} max. (A)	R _s (m Ω)	R _{th} (°C/W)	Part Number	
		H* ± 0.5 (± 0.020)	h ± 2 (± 0.079)	D max.	d ± 0.5 (± 0.020)						
FPG 1500 V											
		V_ndc = 800 V				V_{peak} = 1200 V		V_{rms} = 500 V		V_s = 1500 V	
1	Resin Molding M6/6	49 (1.929)	4.2 (0.165)	40 (1.575)	19 (0.748)	2	15	2.4	14	FPG66R0105J--	
1.5	Resin Molding M6/6	49 (1.929)	4.2 (0.165)	55 (2.165)	19 (0.748)	4.6	20	1.6	10.5	FPG66R0155J--	
2	Plastic Case M8/8	52 (2.047)	5 (0.197)	60 (2.362)	22 (0.866)	8	30	1.2	6.1	FPG86R0205J--	
3	Plastic Case M8/8	52 (2.047)	5 (0.197)	72 (2.835)	22 (0.866)	18	45	0.9	4.5	FPG86R0305J--	
3.5	Plastic Case M8/8	52 (2.047)	5 (0.197)	72 (2.835)	22 (0.866)	25	50	0.85	4.5	FPG86R0355J--	
4	Plastic Case M8/8	52 (2.047)	5 (0.197)	82 (1.575)	22 (0.866)	32	60	0.75	3.5	FPG86R0405J--	
5	Plastic Case M8/8	52 (2.047)	5 (0.197)	82 (3.622)	22 (0.866)	50	70	0.65	2.5	FPG86R0505J--	
6	Resin Molding M8/8	52 (2.047)	5.7 (0.224)	92 (3.622)	28 (1.102)	73	75	0.6	2.5	FPG86R0605J--	
FPG 2000 V											
		V_ndc = 1000 V				V_{peak} = 1600 V		V_{rms} = 600 V		V_s = 2000 V	
0.5	Plastic Case M6/6	52 (2.047)	5 (0.197)	40 (1.575)	18 (0.709)	1	15	3	14	FPG66N0504J--	
1	Plastic Case M8/8	52 (2.047)	5 (0.197)	60 (2.362)	22 (0.866)	3	20	2.3	10.5	FPG86N0105J--	
1.5	Plastic Case M8/8	52 (2.047)	5 (0.197)	60 (2.362)	22 (0.866)	7	30	1.5	6.1	FPG86N0155J--	
2	Plastic Case M8/8	52 (2.047)	5 (0.197)	72 (2.835)	22 (0.866)	12.7	40	1.1	4.5	FPG86N0205J--	
2.5	Plastic Case M8/8	52 (2.047)	5 (0.197)	72 (2.835)	22 (0.866)	20	60	0.89	3.7	FPG86N0255J--	
3	Plastic Case M8/8	52 (2.047)	5 (0.197)	82 (3.228)	22 (0.866)	28	60	0.85	3.2	FPG86N0305J--	
3.5	Plastic Case M8/8	52 (2.047)	5 (0.197)	82 (3.228)	22 (0.866)	39	65	0.78	2.9	FPG86N0355J--	
4	Resin Molding M8/8	52 (2.047)	5.7 (0.224)	92 (3.622)	28 (1.102)	50	70	0.7	2.5	FPG86N0405J--	
FPG 2500 V											
		V_ndc = 1300 V				V_{peak} = 2000 V		V_{rms} = 700 V		V_s = 2500 V	
0.47	Resin Molding M6/6	59 (2.323)	4.2 (0.165)	40 (1.575)	19 (0.748)	0.7	15	6	25	FPG66P0474J--	
1	Resin Molding M6/6	59 (2.323)	4.2 (0.165)	55 (2.165)	19 (0.748)	2	18	3	13	FPG66P0105J--	
1.5	Resin Molding M8/8	59 (2.323)	4.2 (0.165)	60 (2.362)	19 (0.748)	4.5	25	2	10	FPG66P0155J--	
2	Plastic Case M8/8	62 (2.441)	5 (0.197)	72 (2.835)	22 (0.866)	8	35	1.5	6.5	FPG86P0205J--	
2.5	Plastic Case M8/8	62 (2.441)	5 (0.197)	72 (2.835)	22 (0.866)	12.5	40	1.3	4.8	FPG86P0255J--	
3	Resin Molding M8/8	62 (2.441)	5.7 (0.224)	82 (3.228)	28 (1.102)	18	50	1.15	4.4	FPG86P0305J--	
4	Plastic Case M8/8	62 (2.441)	5 (0.197)	92 (3.622)	22 (0.866)	32	65	0.95	3.4	FPG86P0405J--	

 = Preferred standard values

PROTECTION

For higher power protection devices and further information please see PPX Series in Capacitor for High Power Electronics available on AVX website: www.avxcorp.com



Medium Power Film Capacitors



FPG Table of Values

PROTECTION

Dimensions: millimeters (inches)

Cn (μ F)	Case Type	Dimensions				I ² t max. (A ² .s)	I _{rms} max. (A)	R _s (m Ω)	R _{th} (°C/W)	References
		H* ± 0.5 (± 0.020)	h ± 2 (± 0.079)	D max.	d ± 0.5 (± 0.020)					
FPG 2600 V										
		V_{ndc} = 1750 V			V_{peak} = 2000 V		V_{rms} = 800 V		V_s = 2600 V	
0.47	Resin Molding M6/6	59 (2.323)	4.2 (0.165)	40 (1.575)	19 (0.748)	1.4	12	4.04	28	FPG66W0474J--
1	Resin Molding M6/6	59 (2.323)	4.2 (0.165)	55 (2.165)	19 (0.748)	5.7	21	2.17	10.9	FPG66W0105J--
1.5	Resin Molding M6/6	59 (2.323)	4.2 (0.165)	60 (2.362)	19 (0.748)	12.9	31	1.55	7.7	FPG66W0155J--
2	Plastic Case M8/8	62 (2.441)	5 (0.197)	72 (2.835)	22 (0.866)	23	41	1.24	6.1	FPG86W0205J--
2.5	Resin Molding M8/8	62 (2.441)	5.7 (0.224)	82 (3.228)	28 (1.102)	36	51	1.05	4.5	FPG86W0255J--
3	Plastic Case M8/8	62 (2.441)	5 (0.197)	92 (3.622)	22 (0.866)	50	62	0.92	3.9	FPG86W0305J--
3.5	Plastic Case M8/8	62 (2.441)	5 (0.197)	92 (3.622)	22 (0.866)	70	72	0.83	3.4	FPG86W0355J--
3.9	Plastic Case M8/8	62 (2.441)	5 (0.197)	92 (3.622)	22 (0.866)	85	80	0.78	3.1	FPG86W0395J--
FPG 3500 V										
		V_{ndc} = 2000 V			V_{peak} = 2400 V		V_{rms} = 1000 V		V_s = 3500 V	
0.33	Resin Molding M6/6	59 (2.323)	4.2 (0.165)	40 (1.575)	19 (0.748)	2	15	2.5	28	FPG66X0334J--
0.5	Resin Molding M6/6	59 (2.323)	4.2 (0.165)	55 (2.165)	19 (0.748)	5	19	2.5	11.2	FPG66X0504J--
1	Plastic Case M8/8	62 (2.441)	5 (0.197)	72 (2.835)	22 (0.866)	15	38	1.4	6.2	FPG86X0105J--
1.5	Resin Molding M8/8	62 (2.441)	5.7 (0.224)	82 (3.228)	28 (1.102)	40	56	1.03	3.9	FPG86X0155J--
2	Plastic Case M8/8	62 (2.441)	5 (0.197)	92 (3.622)	22 (0.866)	70	75	0.85	3.1	FPG86X0205J--
FPG 4500 V										
		V_{ndc} = 2500 V			V_{peak} = 3200 V		V_{rms} = 1200 V		V_s = 4500 V	
0.22	Resin Molding M6/6	59 (2.323)	4.2 (0.165)	40 (1.575)	19 (0.748)	1.5	15	3.8	25	FPG66Z0224J--
0.47	Resin Molding M6/6	59 (2.323)	4.2 (0.165)	60 (2.362)	19 (0.748)	7	24	2.16	8.5	FPG66Z0474J--
0.68	Plastic Case M8/8	62 (2.441)	5 (0.197)	72 (2.835)	22 (0.866)	14	35	1.59	6.2	FPG86Z0684J--
1	Resin Molding M8/8	62 (2.441)	5.7 (0.224)	82 (3.228)	28 (1.102)	30	52	1.18	4	FPG86Z0105J--
1.25	Plastic Case M8/8	62 (2.441)	5 (0.197)	92 (3.622)	22 (0.866)	50	65	1	3.3	FPG86Z1254J--
FPG 4600 V										
		V_{ndc} = 3000 V			V_{peak} = 4000 V		V_{rms} = 1400 V		V_s = 4600 V	
0.12	Resin Molding M6/6	59 (2.323)	4.2 (0.165)	40 (1.575)	19 (0.748)	0.8	15	6	28	FPG66Y0124J--
0.22	Resin Molding M6/6	59 (2.323)	4.2 (0.165)	60 (2.362)	19 (0.748)	3	20	3.48	11	FPG66Y0224J--
0.33	Plastic Case M8/8	62 (2.441)	5 (0.197)	72 (2.835)	22 (0.866)	6.8	25	2.42	7.7	FPG86Y0334J--
0.47	Resin Molding M8/8	62 (2.441)	5.7 (0.224)	82 (3.228)	28 (1.102)	13.8	35	1.79	5.2	FPG86Y0474J--
0.60	Plastic Case M8/8	62 (2.441)	5 (0.197)	92 (3.622)	22 (0.866)	22	45	1.47	4.2	FPG86Y0604J--

 = Preferred standard values

For higher power protection devices and further information please see PPX Series in Capacitor for High Power Electronics available on AVX website: www.avxcorp.com

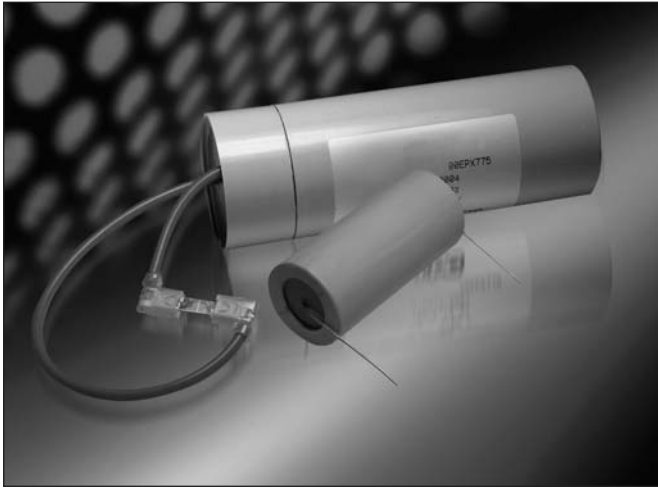

GENERAL DESCRIPTION

FD series use metallized dielectric, controlled self-healing technology, high specific energy.

USUAL APPLICATIONS

The FD capacitors are designed for discharge applications such as Laser, electronic flash, cardiac defibrillator, etc.

FD series offer a very high specific energy level, higher than 1500J per liter for cardiac defibrillator application.

ELECTRICAL CHARACTERISTICS

Operating temperature:	-55°C to +85°C
Storage temperature:	-55°C to +85°C
Capacitance range:	5µF to 150µF other values on request
Capacitance tolerance:	±10%
Nominal charging voltage:	1kV to 3kV higher voltage on request
Test voltage between terminals:	@ 25°C: 1.2 x U _{Ndc} during 10s
Test voltage between terminals and earth:	@ 25°C: 2 U _{Ndc} during 1 min (type test)

DISCHARGE

HOT SPOT CALCULATION

For all applications the temperature in the hot spot capacitor must be lower than 85°C

$$\theta_{\text{hot spot}} = \theta_{\text{ambient}} + (tg\delta_0 \times Q + R_s I_{\text{rms}}^2) \times R_{\text{th}}$$

with $tg\delta_0 = 2 \cdot 10^{-4}$ Q in Vars R_s in Ohm I_{rms} in Ampere R_{th} in °C/W

Medium Power Film Capacitors



FD Design

FDV1

PACKAGING

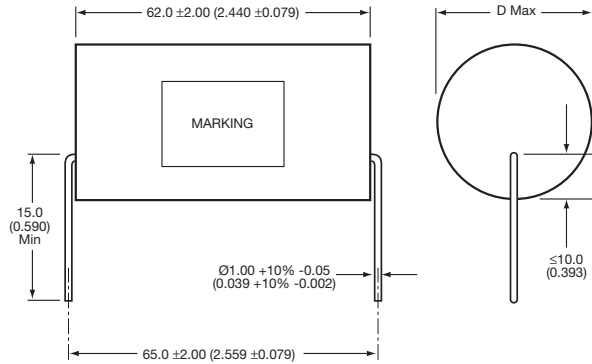

Cylindrical with thermosetting sleeve, sealed with polyurethane resin.

Capacitance (μF)	Max diameter mm (in)	I peak max (A)	I _{rms} max (A)	R _s (m*)	R _{th} (°C/W)	Part Number
U_{ch} = 1000V						
80	50 (1.969)	2500	12	6	15.9	FDV16L0806K--
60	44 (1.732)	2000	12	7.7	17.5	FDV16L0606K--
40	37 (1.457)	1300	10	11	18.2	FDV16L0406K--
20	28 (1.102)	650	5	21.1	17.3	FDV16L0206K--
U_{ch} = 1400V						
50	51 (2.008)	2100	12	7.1	16	FDV16Q0506K--
30	41 (1.614)	1250	11.5	11.2	17.3	FDV16Q0306K--
20	35 (1.378)	800	7.5	16.3	18.4	FDV16Q0206K--
10	27 (1.063)	400	3.5	31.5	17.3	FDV16Q0106K--
U_{ch} = 1700V						
35	51 (2.008)	1750	12	8.3	16	FDV16S0356K--
25	44 (1.732)	1250	12	11	17.2	FDV16S0256K--
15	35 (1.378)	750	7.5	18	18.5	FDV16S0156K--
5	24 (0.945)	250	2.5	51.9	15.9	FDV16S00505K--

DISCHARGE

LIFETIME EXPECTANCY vs VOLTAGE AND HOT SPOT TEMPERATURE

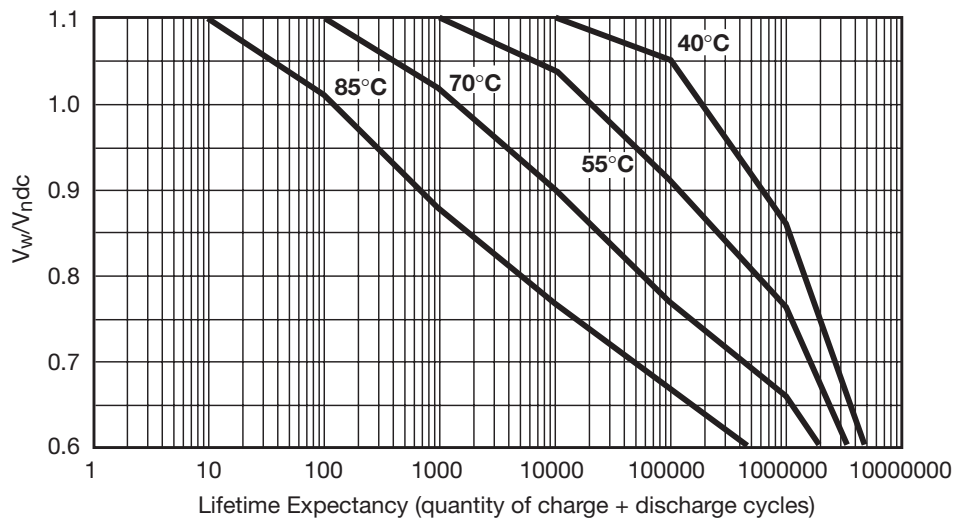

V_w: operating or working charge voltage

Medium Power Film Capacitors



FD Design

FDBB

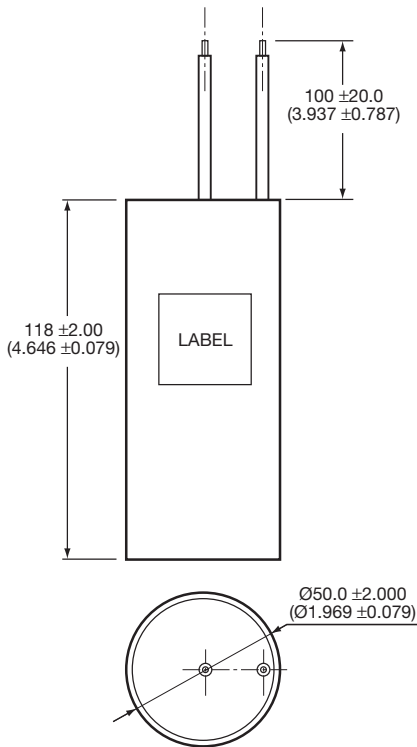

DESIGN

Cylindrical plastic case filled with polyurethen resin

LIFETIME EXPECTANCY

7500 shots under 35°C hot spot temperature, reversal voltage = 10% max, charge duration 1s, hold time 1s

SPECIFIC PRODUCTS

For all other voltages, values, specific proposal will be done.

Requested elements:

- *Voltage charge
- *Reversal voltage
- *Voltage hold time
- *Discharge rate
- *Discharge time
- *Charge time
- *Lifetime
- *Temperature of use

Capacitance (µF)	Energy Joule	Energy Density (J/l)	I peak max (A)	Part Number
1800 Volts				
150	243	1062	2800	FDBB6S0157K--
2500 Volts				
100	312.5	1366	2300	FDBB6P0107K--
3000 Volts				
70	315	1377	2000	FDBB6X0706K--

DISCHARGE

Medium Power Film Capacitors



FAV General Description

TUNING

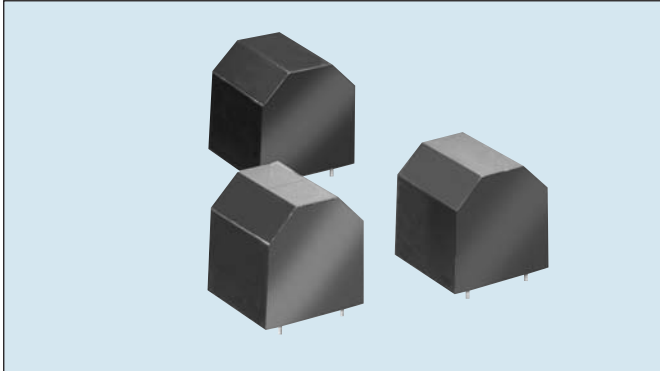

APPLICATIONS

High reactive energy tuning for converters.
Protection of semi-conductors.

TECHNOLOGY

Metallized polypropylene film and metal foil.
Dry capacitor.

PACKAGING

Rectangular resin case.
4 leads 1.2 x 0.8mm for printed circuit board mounting.
Self-extinguishing plastic case (V0 = in accordance with UL 94) filled thermosetting resin.
Self-extinguishing thermosetting resin (V0 = in accordance with UL 94; I3F2 = in accordance with NF F 16-101).
(Note that FFV3 and FAV3 are in the same packaging.)

ELECTRICAL CHARACTERISTICS

Climatic category	40/085/56 (IEC 60068)
Working temperature	hot spot temperature: -40°C to +85°C
Hot spot temperature	≤85°C (must be calculated: see below)
Capacitance range C_n	80 to 1200nF
Tolerance	±10%
Rated AC voltage	$V_{n,rms} = 300$ to 650 V
Rated DC voltage	$V_{n,dc} = 600$ to 2000 V
Maximum rms current	$I_{rms\ max} = 10$ to 40 Arms
Maximum reactive power	$Q\ max = 7$ to 14 kvar
Stray inductance	15 nH
Test voltage between terminals	$1.5 \times V_{n,dc}$ 10s
Withstanding voltage between terminals and case	3000 Vrms 60s

STANDARDS

- IEC 61071-1: IEC 61071-2: Power electronic capacitors
- IEC 60068-1: Environmental testing
- IEC 60077: Rules for electric traction equipment
- UL 94: Fire requirements
- NF F 16-101
- NF F 16-102: Fire and smoke requirements

HOT SPOT TEMPERATURE CALCULATION

$$\theta_{hot\ spot} = \theta_{ambient} + (P_d + P_t) \times (R_{th} + 7.4)$$

with P_d (Dielectric losses) = $Q \times tg\delta_0$

$$\Rightarrow [\frac{1}{2} \times C \times (V_{peak\ to\ peak})^2 \times fr] \times 2.10^{-4}$$

$$\Rightarrow \text{Protections applications}$$

$$\Rightarrow (V^2 \times C \times 2 \pi \times Fr) \times 2.10^{-4}$$

$$\Rightarrow \text{Tuning applications}$$

$$P_c \text{ (Joule losses)} = R_s \times (I_{rms})^2$$

where

Q in Var R_s in Ohm R_{th} in °C/W

LIFETIME EXPECTANCY

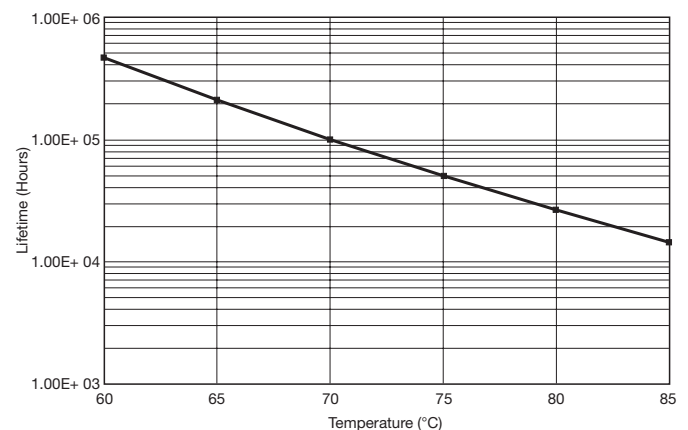

Medium Power Film Capacitors



FAV

TUNING

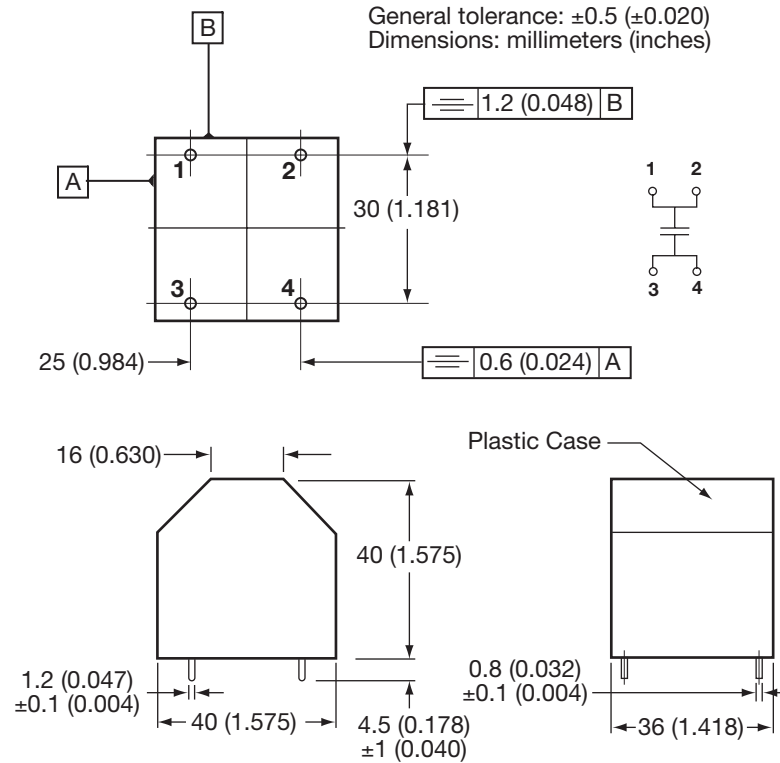

C _n (nF)	I _{rms} max (A)	Q max (kV)	R _s (mΩ)	L _s (nH)	R _{th} (°C/W)	Part Number
V_{Ndc} 600 V		V_{rms}: 300 V				
1200	40	12	0.85	5	4	FAV36K0125K--
1000	32	10	1	5	4.1	FAV36K0105K--
V_{Ndc} 800 V		V_{rms}: 400 V				
800	35	14	0.9	5	4	FAV36B0804K--
620	27	11	1.1	5	4.1	FAV36B0624K--
V_{Ndc} 1000 V		V_{rms}: 450 V				
560	30	14	1	5	4	FAV36L0564K--
470	25	12	1.2	5	4.1	FAV36L0474K--
V_{Ndc} 1200 V		V_{rms}: 500 V				
330	21	11	1.4	5	4.2	FAV36U0334K--
270	17	9	1.7	5	4.4	FAV36U0274K--
V_{Ndc} 1500 V		V_{rms}: 600 V				
180	16	10	1.7	5	4.4	FAV36R0184K--
150	13	8	2	5	4.5	FAV36R0154K--
V_{Ndc} 2000 V		V_{rms}: 650 V				
120	15	10	1.92.2	5	4.6	FAV36N0124K--
100	12	8	2.8	5	4.9	FAV36N0104K--
80	10	7	1.5	5	5.2	FAV36N0803K--

TUNING

TUNING

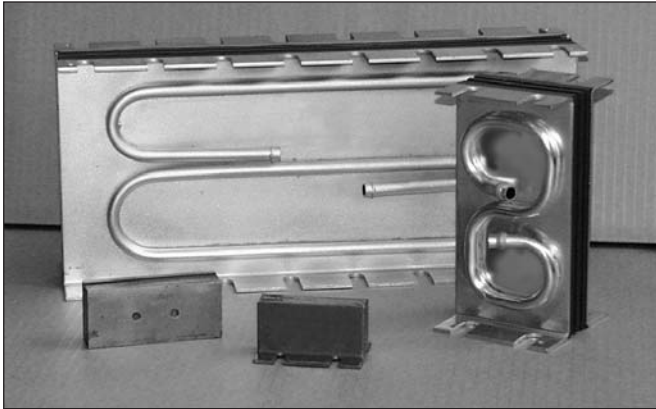

The FAI series uses metallized polypropylene dielectric specifically designed for very high reactive power.

The FAI's special design gives to this series a very low level of stray inductance.

APPLICATIONS

These capacitors have been designed principally for:
low and medium frequency applications
(10 kHz to 500 kHz)

ELECTRICAL CHARACTERISTICS

Capacitance range C_n	110nF to 60 μ F
Tolerance	$\pm 10\%$
Rated AC voltage	200 to 650 Vrms
Series parasitic inductance	< 5 nH
Test voltage between terminals @ 25°C	1.2 Vrms 50/60 Hz 10s

MAXIMUM WORKING TEMPERATURE (HOT SPOT)

+85°C: Hot spot temperature must be calculated as function of power dissipation.

HOT SPOT (THERMAL) CALCULATION

You can calculate the maximum operating (hot spot) temperature of this capacitor in the following manner:

Polypropylene has a constant loss factor ($\text{tg}\delta_0$) of 2×10^{-4} irrespective of temperature and frequency (up to 1 MHz).

The loss factor of the capacitor is made up of the sum of two components. The first represents electrical losses ($\text{tg}\delta_0 = 2 \cdot 10^{-4}$) and the second represents Joule effect in the connection and foils: $R_s \cdot C \cdot 2\pi F$.

For all applications, the temperature in the hot spot capacitor must be lower than 85°C.

Heating calculation of hot spot capacitor: FAI1 FAI2 FAI3

$$\theta_{\text{hot spot}} = \theta_{\text{terminals}} + (\text{tg}\delta_0 \cdot Q + R_s \cdot (I_{\text{rms}})^2) \cdot R_{\text{th}}$$

Heating calculation of hot spot capacitor: FAI6

$$\theta_{\text{hot spot}} = \theta_{\text{water}} + (\text{tg}\delta_0 \cdot Q + R_s \cdot (I_{\text{rms}})^2) \cdot R_{\text{th}}$$

With: $\text{tg}\delta_0 = 2 \cdot 10^{-4}$

Q in Var

R_s in Ohms

I_{rms} in Amperes

R_{th} in °C/W (water flow = 10 dm³/minute)

Note: The life time depends of hot spot temperature, see following curve.

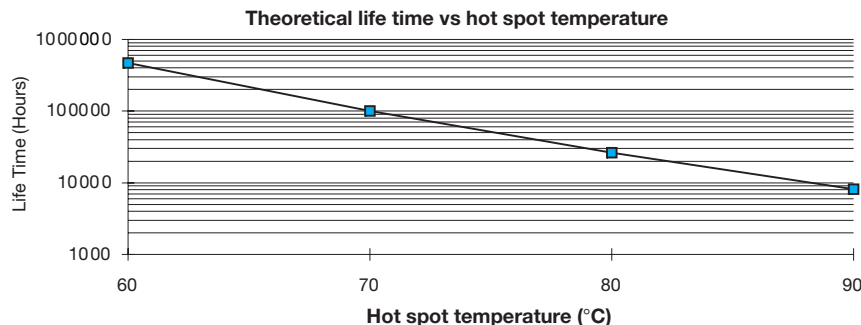

Medium Power Film Capacitors



FAI

TUNING FAI1 VERSION

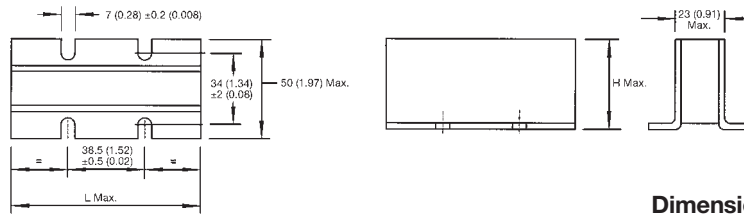

Dimensions: millimeters (inches)

C (nF)	Irms max (A)	Vrms max (V)	Q max kVARs	Rs (mΩ)	Rth (°C/W)	L max	H max	Part Number
110	180	500	100	$8 \times 10^{-4} \times \sqrt{F} + 0.19$	0.86	55 (2.165)	35 (1.378)	FAI16J0114K--
210	300	500	150	$5 \times 10^{-4} \times \sqrt{F} + 0.12$	0.67	75 (2.953)	40 (1.575)	FAI16J0214K--
330	350	500	175	$5 \times 10^{-4} \times \sqrt{F} + 0.15$	0.54	75 (2.953)	40 (1.575)	FAI16J0334K--
510	500	500	250	$4 \times 10^{-4} \times \sqrt{F} + 0.08$	0.49	95 (3.740)	45 (1.772)	FAI16J0514K--
660	600	500	300	$3.5 \times 10^{-4} \times \sqrt{F} + 0.06$	0.38	95 (3.740)	45 (1.772)	FAI16J0664K--

With F in Hz

FAI2 VERSION

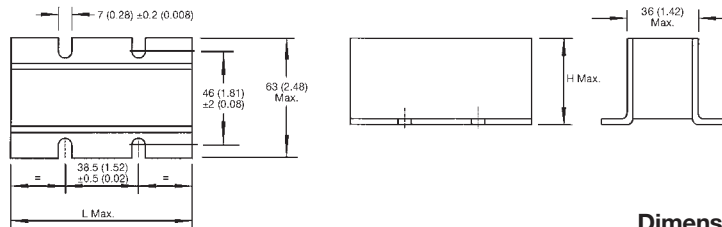

Dimensions: millimeters (inches)

C (nF)	Irms max (A)	Vrms max (V)	Q max kVARs	Rs (mΩ)	Rth (°C/W)	L max	H max	Part Number
660	300	500	180	$5 \times 10^{-4} \times \sqrt{F} + 0.25$	0.6	75 (2.953)	40 (1.575)	FAI26J0664K--
1200	400	500	200	$5 \times 10^{-4} \times \sqrt{F} + 0.20$	0.56	75 (2.953)	40 (1.575)	FAI26J0125K--
2400	500	350	175	$5 \times 10^{-4} \times \sqrt{F} + 0.17$	0.55	75 (2.953)	40 (1.575)	FAI26I0245K--

With F in Hz

FAI3 VERSION

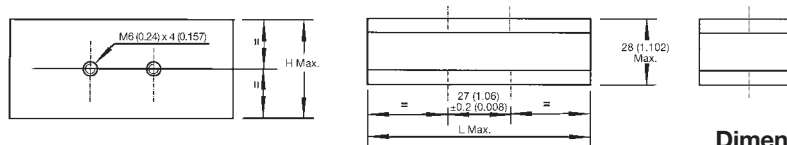

Dimensions: millimeters (inches)

C (nF)	Irms max (A)	Vrms max (V)	Q max kVARs	Rs (mΩ)	Rth (°C/W)	L max	H max	Part Number
110	180	500	100	0.3	0.82	55 (2.165)	35 (1.378)	FAI36J0114K--
330	350	500	175	0.15	0.55	75 (2.953)	37 (1.457)	FAI36J0334K--
510	500	500	250	0.1	0.3	95 (3.740)	42 (1.654)	FAI36J0514K--
660	600	500	300	0.1	0.24	95 (3.740)	42 (1.654)	FAI36J0664K--

FAI4 VERSION

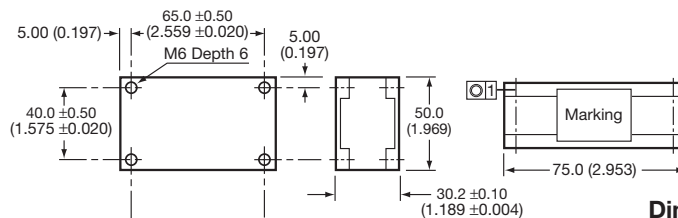

Dimensions: millimeters (inches)

C (nF)	Irms max (A)	Vrms max (V)	Q max kVARs	Rs (mΩ)	Rth (°C/W)	Part Number
4000	600	300	180	0.13	0.15	FAI46H0405K--
2400	500	400	200	0.15	0.20	FAI46I0245K--
1800	550	450	230	0.35	0.38	FAI46J0185K--
1200	500	500	200	0.20	0.22	FAI46J0125K--
660	450	500	220	0.26	0.32	FAI46J0664K--
330	380	600	220	0.315	0.315	FAI46K0334K--
280	320	600	190	0.37	0.375	FAI46K0284K--



Medium Power Film Capacitors



FAI

TUNING

110 nF 500 Vrms
FAI16J0114K--
FAI36J0114K--

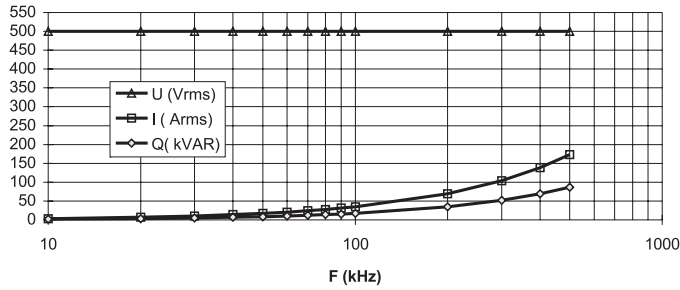

660 nF 500 Vrms
FAI16J0664K--
FAI36J0664K--

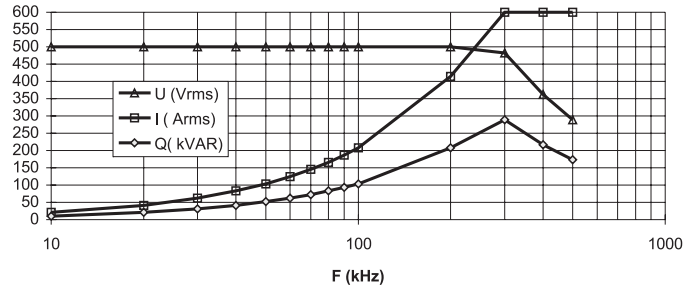

210 nF 500 Vrms
FAI16J0214K--

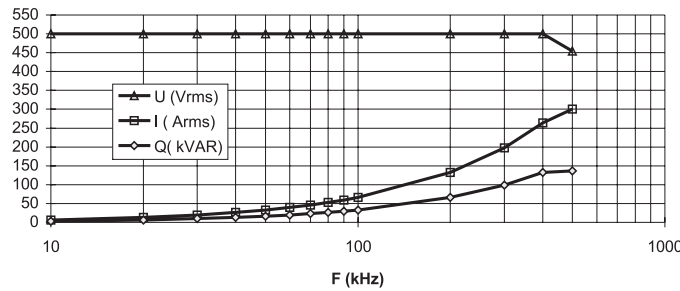

660 nF 500 Vrms
FAI26J0664K--

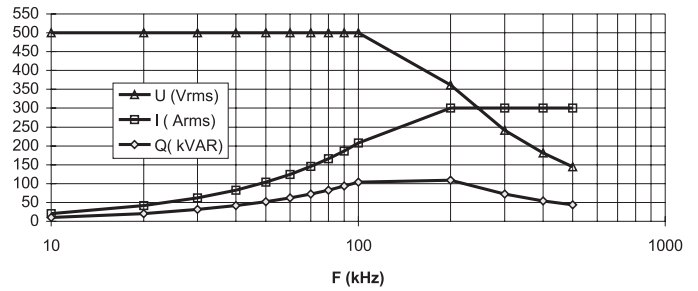

330 nF 500 Vrms
FAI16J0334K--
FAI36J0334K--

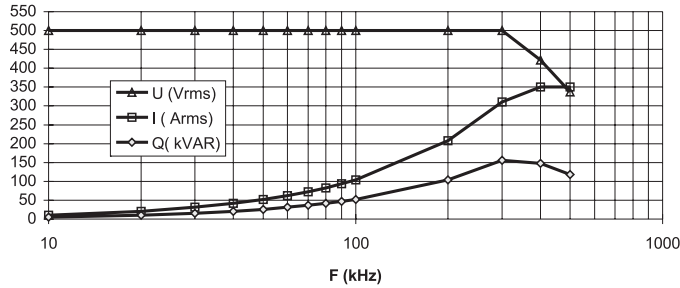

1200 nF 500 Vrms
FAI26J0125K--

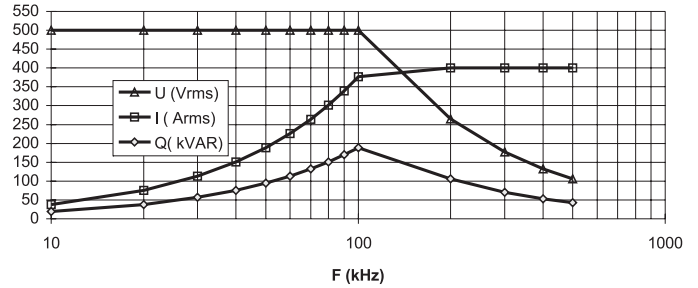

510 nF 500 Vrms
FAI16J0514K--
FAI36J0514K--

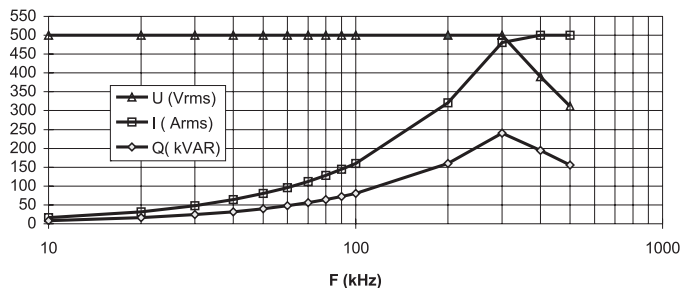

2400 nF 350 Vrms
FAI26I0245K--

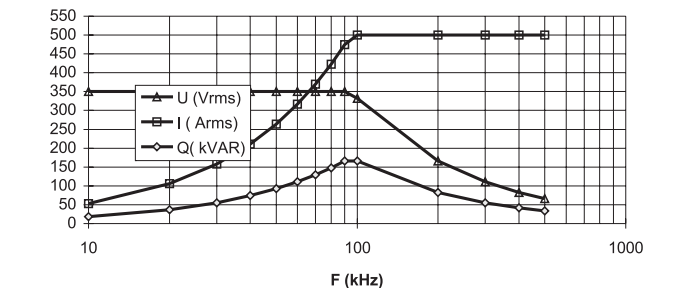

TUNING



Medium Power Film Capacitors



FAI

TUNING

FAI46H0405K--
4000nF±10% 300Vrms

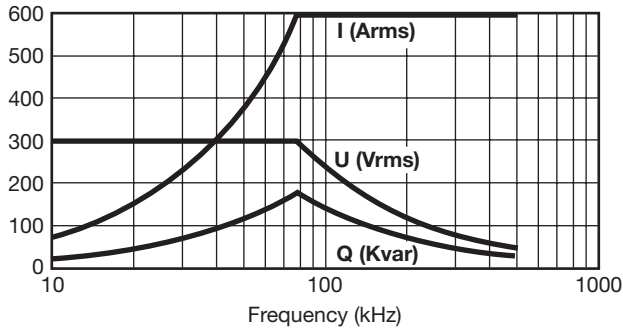

FAI46I0245K--
2400nF±10% 400Vrms

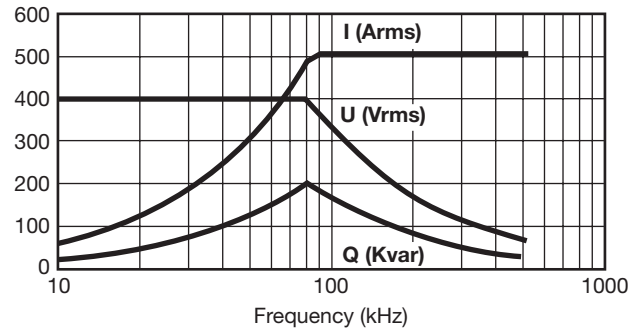

FAI46J0185K--
1800nF±10% 450Vrms

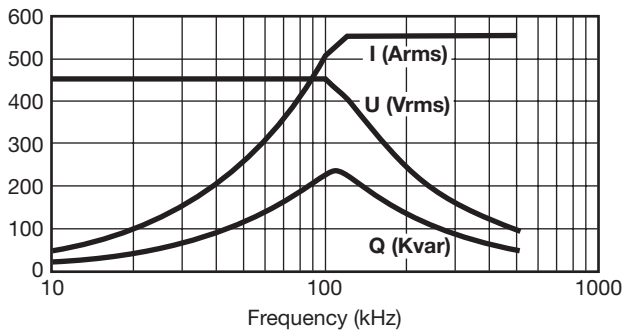

FAI46J0664K--
660nF±10% 500Vrms

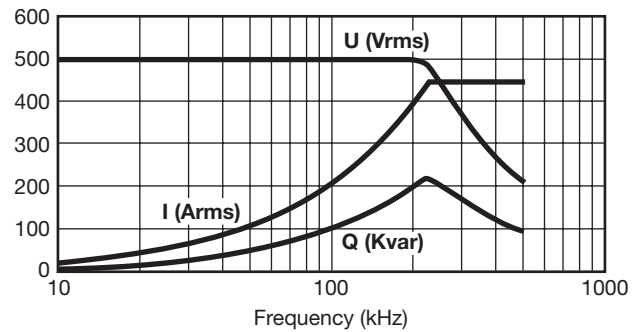

FAI46J0334K--
330nF±10% 600Vrms

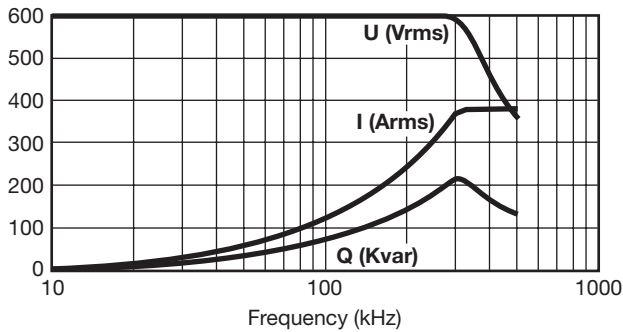

FAI46J0284K--
280nF±10% 600Vrms

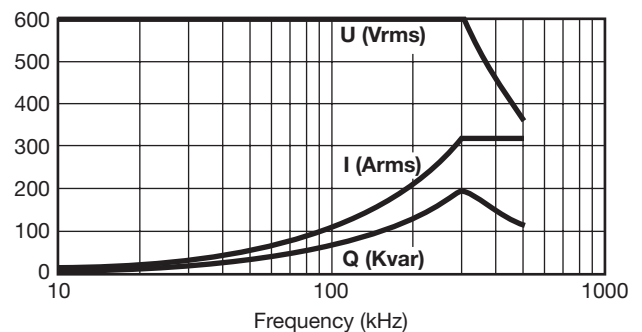

TUNING

Medium Power Film Capacitors



FAI

TUNING

FAI6

Dimensions: millimeters (inches)

Width	Vrms max (V)	C (μF)	Qmax (kVAR)	Irms max (A)	Rs (mΩ)	Rth (°C/W)	Part Number
90 (3.543)	200	15	160	800	$5.10^{-4} \times \sqrt{f(\text{Hz})} + 0.025$	0.104	FAI66F0156K--
	300	12	240	800	$5.10^{-4} \times \sqrt{f(\text{Hz})} + 0.03$	0.104	FAI66H0126K--
	400	7	320	800	$5.10^{-4} \times \sqrt{f(\text{Hz})} + 0.035$	0.114	FAI66I0705K--
	500	5	320	640	$5.10^{-4} \times \sqrt{f(\text{Hz})} + 0.04$	0.114	FAI66J0505K--
	600	3.5	320	530	$5.10^{-4} \times \sqrt{f(\text{Hz})} + 0.05$	0.124	FAI66K0355K--
	650	1.5	320	490	$5.10^{-4} \times \sqrt{f(\text{Hz})} + 0.07$	0.134	FAI66A0155K--
190 (7.480)	200	30	240	1200	$2.5.10^{-4} \times \sqrt{f(\text{Hz})} + 0.0125$	0.079	FAI66F0306K--
	300	24	360	1200	$2.5.10^{-4} \times \sqrt{f(\text{Hz})} + 0.015$	0.079	FAI66H0246K--
	400	14	480	1200	$2.5.10^{-4} \times \sqrt{f(\text{Hz})} + 0.0175$	0.084	FAI66I0146K--
	500	10	600	1200	$2.5.10^{-4} \times \sqrt{f(\text{Hz})} + 0.02$	0.084	FAI66J0106K--
	600	7	640	1070	$2.5.10^{-4} \times \sqrt{f(\text{Hz})} + 0.025$	0.089	FAI66K0705K--
	650	3	640	985	$2.5.10^{-4} \times \sqrt{f(\text{Hz})} + 0.035$	0.094	FAI66A0305K--
290 (11.417)	200	45	320	1600	$2.10^{-4} \times \sqrt{f(\text{Hz})} + 0.0083$	0.072	FAI66F0456K--
	300	36	480	1600	$2.10^{-4} \times \sqrt{f(\text{Hz})} + 0.01$	0.072	FAI66H0366K--
	400	21	640	1600	$2.10^{-4} \times \sqrt{f(\text{Hz})} + 0.0117$	0.075	FAI66I0216K--
	500	15	800	1600	$2.10^{-4} \times \sqrt{f(\text{Hz})} + 0.0133$	0.075	FAI66J0156K--
	600	10.5	960	1600	$2.10^{-4} \times \sqrt{f(\text{Hz})} + 0.0167$	0.078	FAI66K1055K--
	650	4.5	960	1480	$2.10^{-4} \times \sqrt{f(\text{Hz})} + 0.0233$	0.082	FAI66A0455K--
390 (15.354)	200	60	400	2000	$1.5.10^{-4} \times \sqrt{f(\text{Hz})} + 0.00625$	0.067	FAI66F0606K--
	300	48	600	2000	$1.5.10^{-4} \times \sqrt{f(\text{Hz})} + 0.0075$	0.067	FAI66H0486K--
	400	28	800	2000	$1.5.10^{-4} \times \sqrt{f(\text{Hz})} + 0.00875$	0.070	FAI66I0286K--
	500	20	1000	2000	$1.5.10^{-4} \times \sqrt{f(\text{Hz})} + 0.01$	0.070	FAI66J0206K--
	600	14	1200	2000	$1.5.10^{-4} \times \sqrt{f(\text{Hz})} + 0.0125$	0.072	FAI66K0146K--
	650	6	1280	1970	$1.5.10^{-4} \times \sqrt{f(\text{Hz})} + 0.0175$	0.075	FAI66A0605K--

Medium Power Film Capacitors



FAI

TUNING

Dimensions: millimeters (inches)

FAI6 WIDTH: 90 (3.543)

FAI6 WIDTH: 290 (11.417)

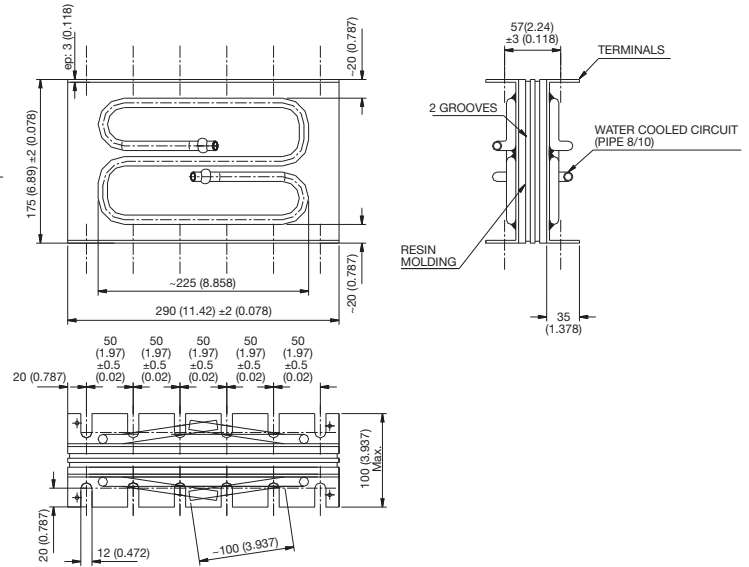
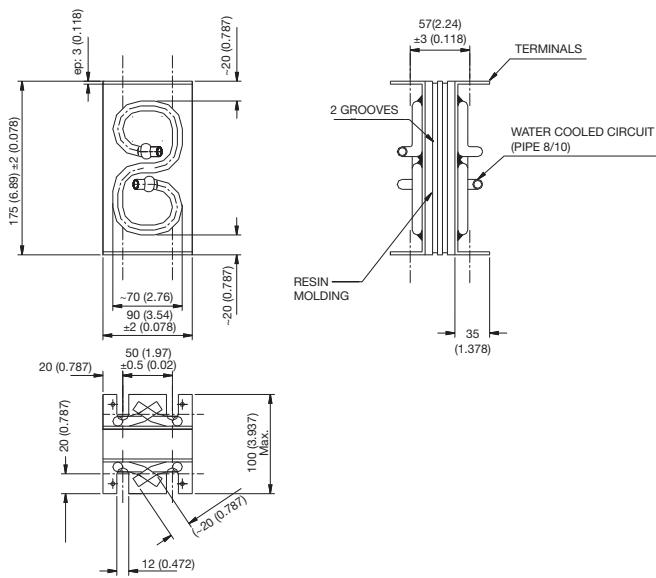

FAI6 WIDTH: 190 (7.480)

FAI6 WIDTH: 390 (15.354)

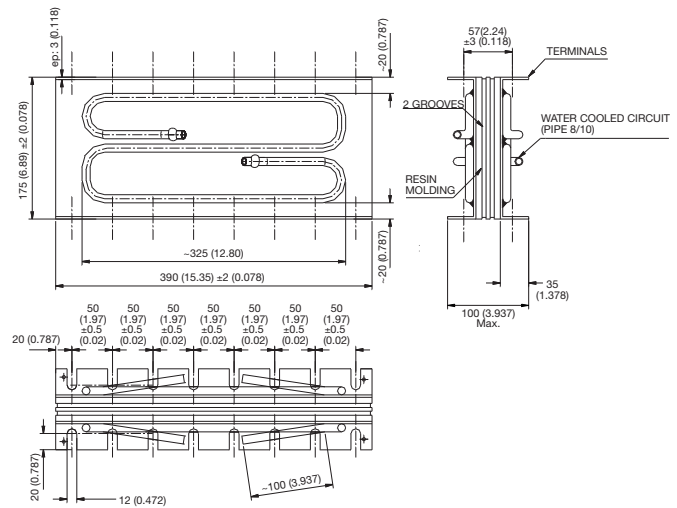
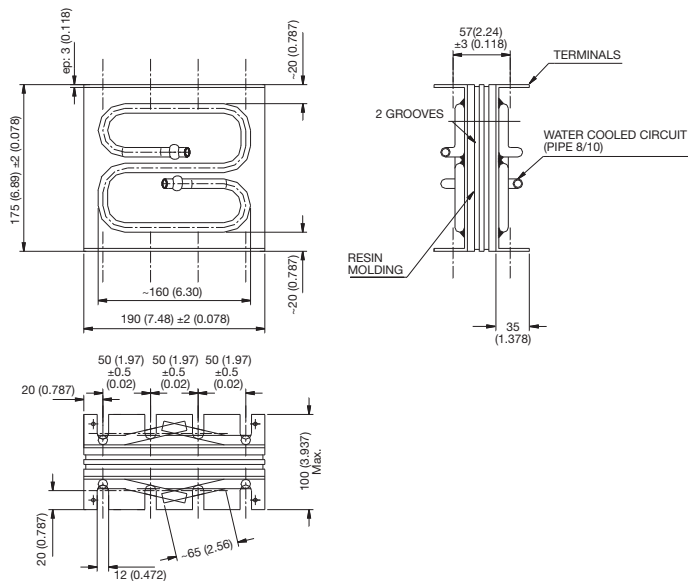

TUNING



Medium Power Film Capacitors



FAI

TUNING

15 μ F 200 Vrms Width 90 mm
FAI66F0156K--

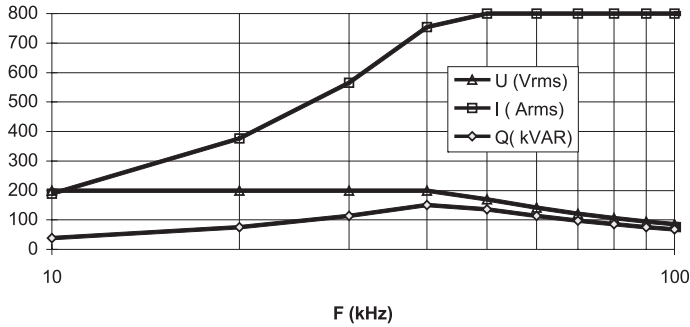

12 μ F 300 Vrms Width 90 mm
FAI66H0126K--

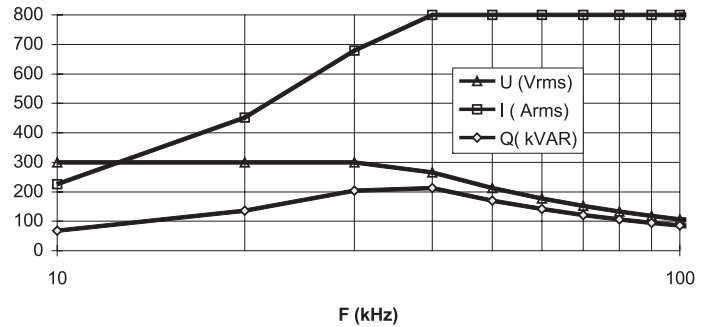

30 μ F 200 Vrms Width 190 mm
FAI66F0306K--

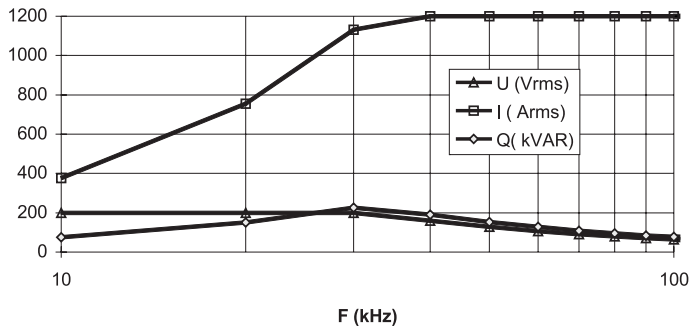

24 μ F 300 Vrms Width 190 mm
FAI66H0246K--

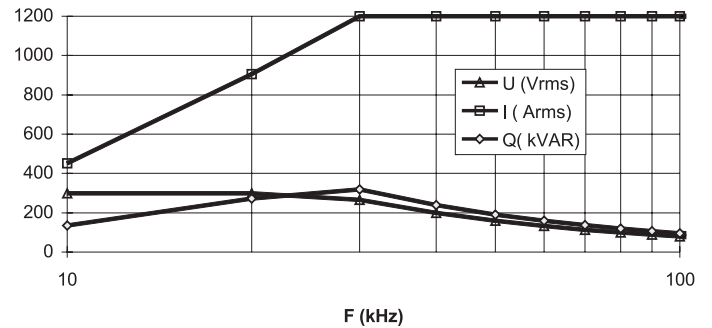

45 μ F 200 Vrms Width 290 mm
FAI66F0456K--

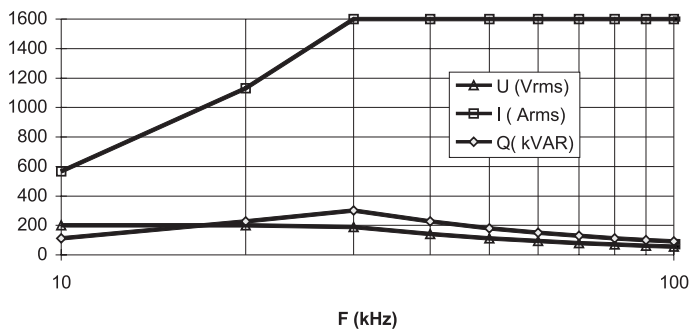

36 μ F 300 Vrms Width 290 mm
FAI66H0366K--

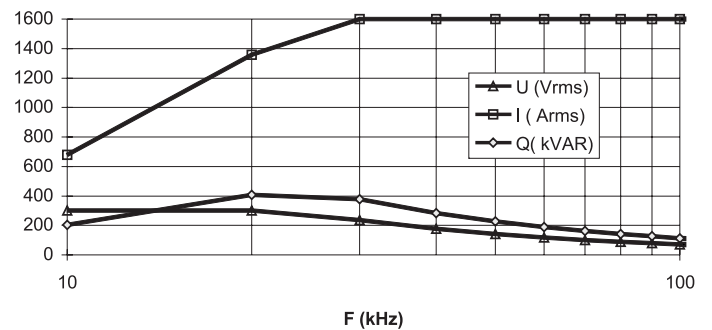

60 μ F 200 Vrms Width 390 mm
FAI66F0606K--

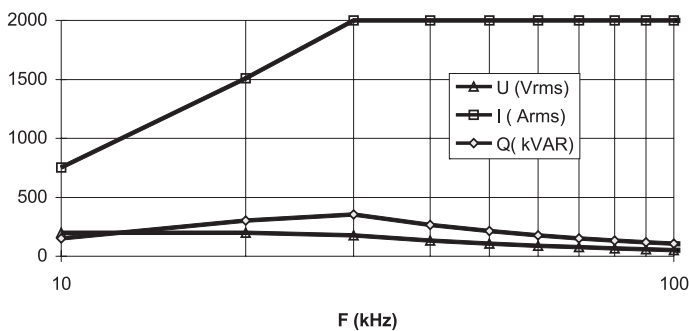

48 μ F 300 Vrms Width 390 mm
FAI66H0486K--

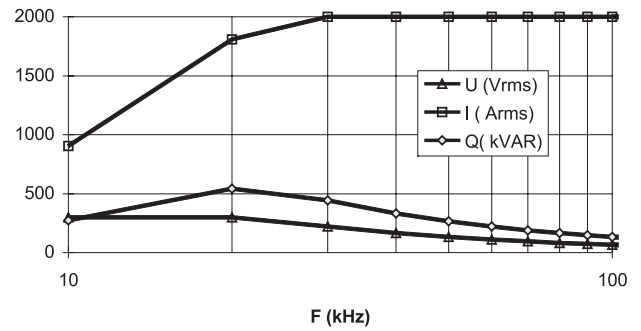

TUNING



Medium Power Film Capacitors



FAI

TUNING

7 μ F 400 Vrms Width 90 mm
FAI66I0705K--

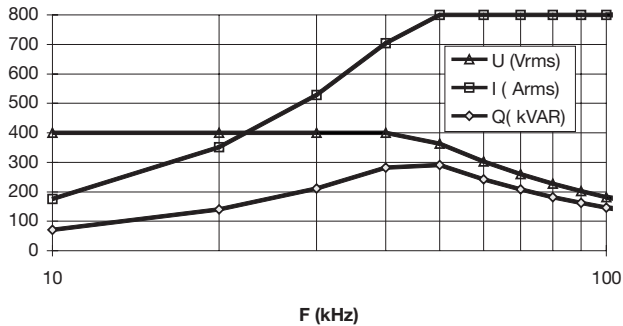

5 μ F 500 Vrms Width 90 mm
FAI66J0505K--

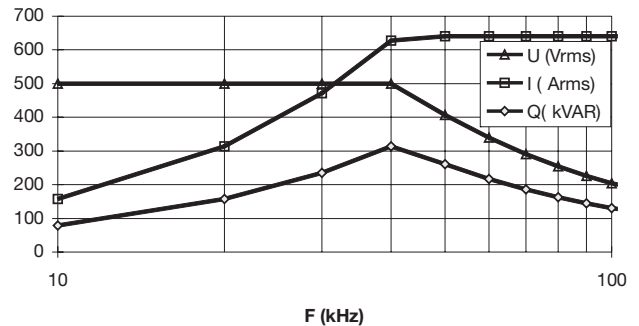

14 μ F 400 Vrms Width 190 mm
FAI66I0146K--

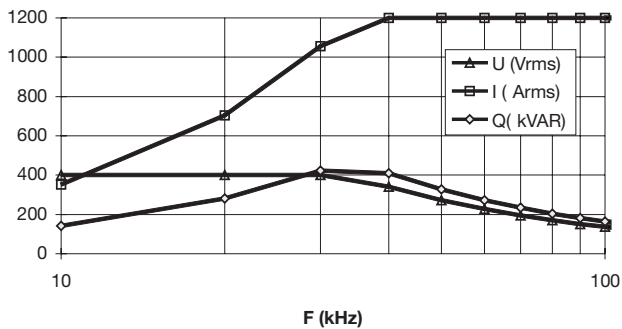

10 μ F 500 Vrms Width 190 mm
FAI66J0106K--

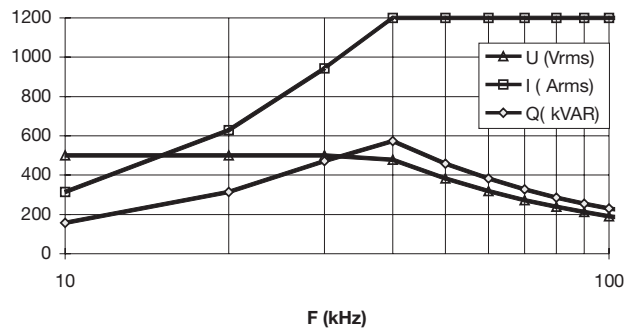

21 μ F 400 Vrms Width 290 mm
FAI66I0216K--

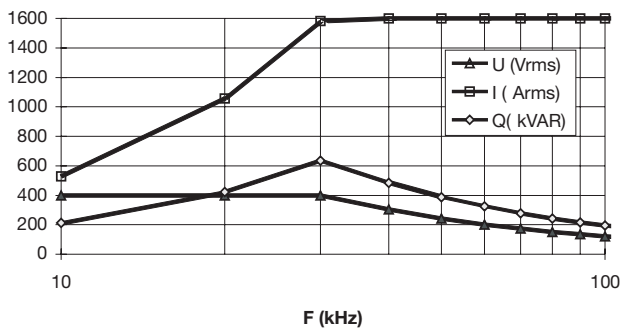

15 μ F 500 Vrms Width 290 mm
FAI66J0156K--

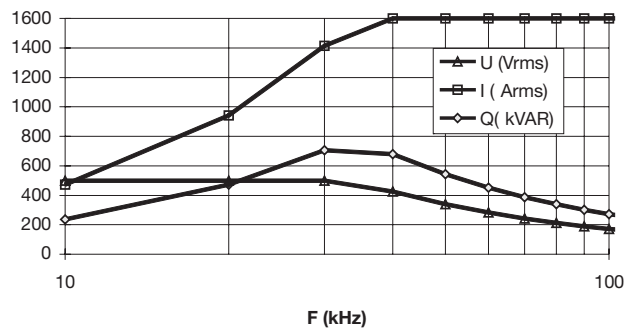

28 μ F 400 Vrms Width 390 mm
FAI66I0286K--

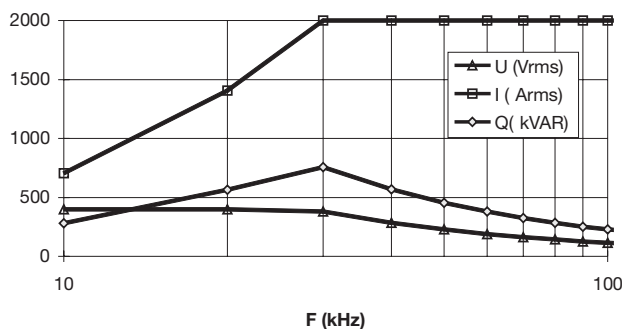

20 μ F 500 Vrms Width 390 mm
FAI66J0206K--

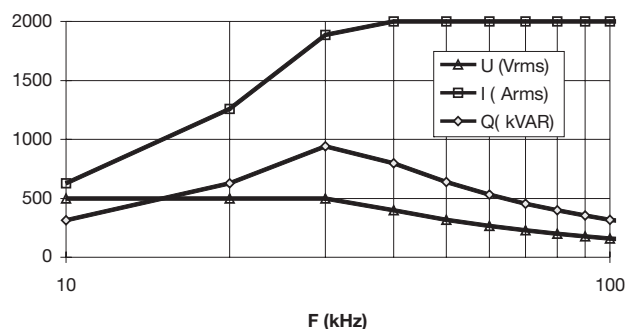

TUNING

Medium Power Film Capacitors



FAI

TUNING

3.5 μ F 600 Vrms Width 90 mm
FAI66K0355K--

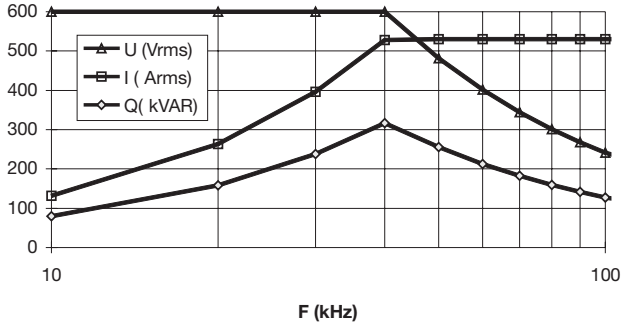

1.5 μ F 650 Vrms Width 90 mm
FAI66A0155K--

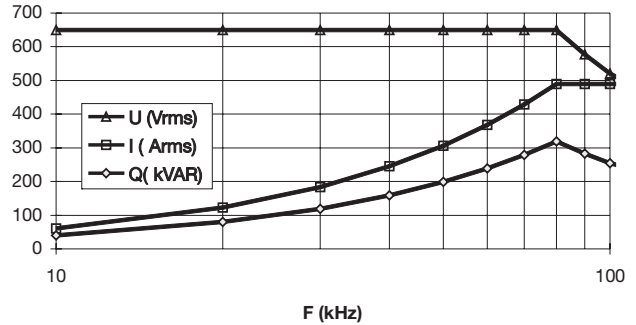

7 μ F 600 Vrms Width 190 mm
FAI66K0705K--

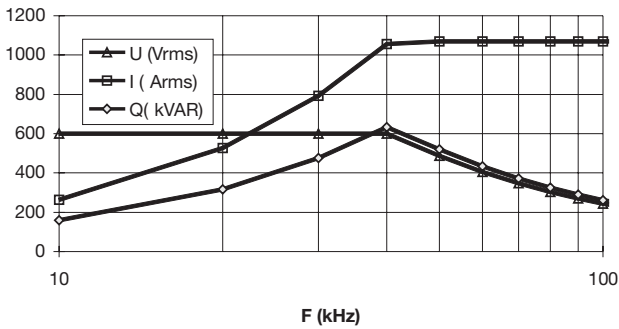

3 μ F 650 Vrms Width 190 mm
FAI66A0305K--

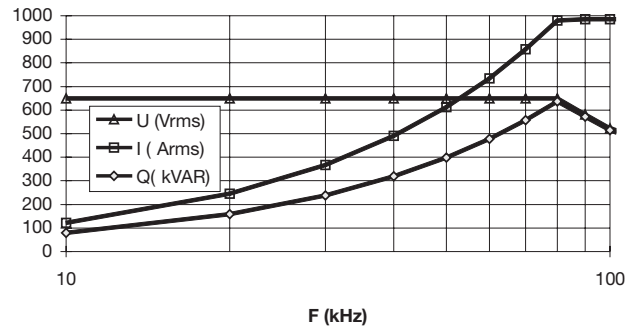

10.5 μ F 600 Vrms Width 290 mm
FAI66K1055K--

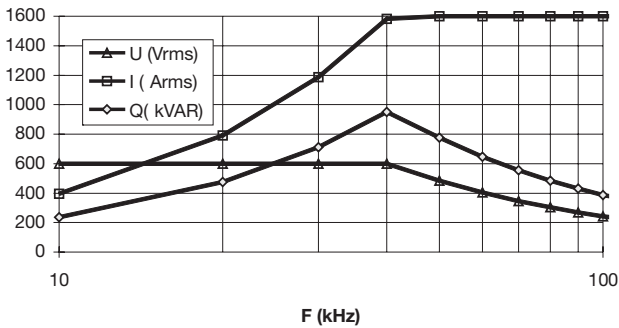

4.5 μ F 650 Vrms Width 290 mm
FAI66A0455K--

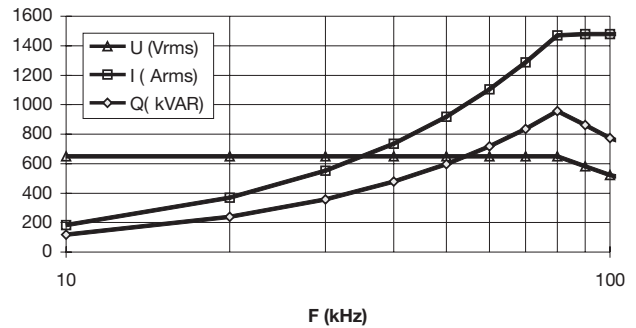

14 μ F 600 Vrms Width 390 mm
FAI66K0146K--

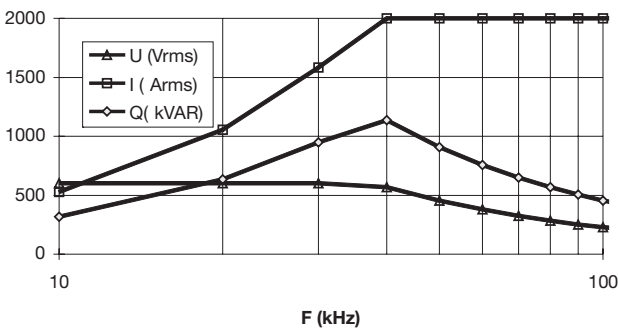

6 μ F 650 Vrms Width 390 mm
FAI66A0605K--

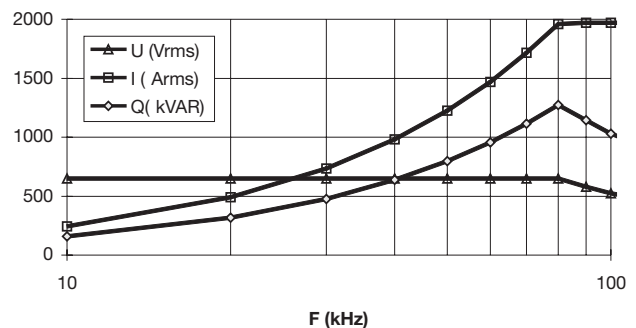

TUNING



Application Notes

INDUCTION HEATING

APPLICATIONS

Local thermal treatment, metallic surface hardening, pipe welding, tin coating treatment,...

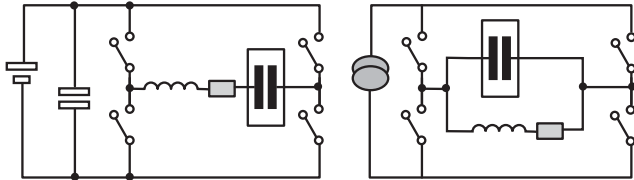

FUNCTION, PRODUCTS

DC Filtering

The purpose of this filter is to smooth the low frequency ripple coming from the bridge (up to 360 Hz) and to filter the high frequency ripple coming from the converter (15/20 kHz)*.

*Frequency will be lower than capacitor resonance frequency, on request, TPC can propose specific models for high frequency.

Main criteria are: High rms. current and good behavior against overvoltage are needed.

Products to offer

FFG	5 to 160 μ F	600 to 1900Vdc
FFVE	12 to 400 μ F	300 to 1900Vdc
FFVI	47 to 275 μ F	500 to 1100Vdc
FFLI/FFLB	58 to 800 μ F	680 to 1900Vdc
FFLC	1120 to 8800 μ F	680 to 1200Vdc

Tuning

In order to obtain the requested frequency, a capacitor is needed to tune with the inductance. The main characteristic of this capacitor is the reactive power (express in kVar) versus frequency.

Products to offer

FAI6	10 kHz \leq F \leq 100 kHz	1.5 to 60 μ F
		200 to 650Vrms
		160 to 1280kVar
FAI1 to 4	100 kHz \leq F \leq 500 kHz	110 to 4000nF
		300 to 600Vrms
		100 to 300kVar

TRACTION

APPLICATIONS

Speed converter for power for mass transit and/or people mover system.

FUNCTION, PRODUCTS

DC Filtering

The purpose of the product is to filter the high frequency ripple coming from the converter in order to avoid rejection and perturbation on the network.

TPC has developed controlled-self healing range allowing reliable and competitive solution compare electrolytic technology.

See calculation example how to replace electrolytic technology.

Note that on new developments based on IGBT converter, manufacturer wish to have a main DC filter close to the converter and some light filters sprayed on the line.

Products to offer

Main DC Filter	FFLC	1120 to 8800 μ F	up to 1200Vdc
Additional	FFLI/FFLB	58 to 800 μ F	up to 1900Vdc
DC Filter	FFVE	12 to 400 μ F	up to 1900Vdc
	FFG	5 to 160 μ F	up to 1900Vdc

Protection of semi-conductors

Overvoltage and clamping due to switching of semi-conductors.

Products to offer

Thyristors and			
GTO snubbers	FPX	0.5 μ F to 6 μ F	up to 4600V*
IGBT clamping	FSB	0.1 to 2.5 μ F	up to 2kVdc
	FFVE	12 to 400 μ F	up to 1.9kVdc

*higher voltage on request

POWER SUPPLIES AND RESONANT CONVERTER

APPLICATIONS

Medical	X-ray, scanner power supplies
Traction	Battery charger
Industrial	All application requesting power supplies

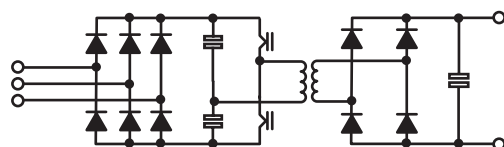
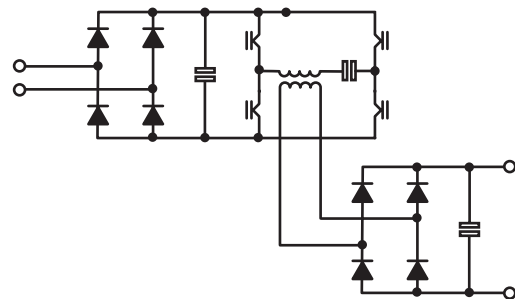

Application Notes

FUNCTION, PRODUCTS

DC Filtering

The purpose of this filter is to smooth the low frequency ripple coming from the bridge (up to 360 Hz) and to filter the high frequency ripple coming from the converter (15/20 kHz). High rms. current and good behavior against overvoltage are needed.

Products to offer

FFB/FFV3	1.5 to 160 μ F	75 to 1100Vdc
FFG	5 to 160 μ F	600 to 1900Vdc
FFVE	12 to 400 μ F	300 to 1900Vdc
FFVI	47 to 275 μ F	500 to 1100Vdc
FFLI/FFLB	58 to 800 μ F	680 to 1900Vdc

Tuning

In order to obtain the requested frequency, a capacitor is needed to tune with the inductance transformer.

The main characteristic of this capacitor is the reactive power and rms. current.

Products to offer

FAV	80 to 1200nF	up to 650Vrms
FAI1 to 4	110 to 4000nF	up to 600Vrms

Protection of semi-conductors

Overvoltage and clamping due to switching of semi-conductors.

Products to offer

IGBT clamping	FSB	0.1 to 3 μ F	up to 2kVdc
Mos-Fet transistor protection	FSV	10nF to 150nF	up to 2kVdc

SPEED CONVERTER

APPLICATIONS

Speed converter for medium power (20 to 100kW)
Traction: auxiliary converter for air cooling system, light,...
Industrial: speed variation

FUNCTION, PRODUCTS

DC Filtering

The purpose of this product is to filter the high frequency ripple coming from the converter in order to avoid rejection and perturbation on the network.

Due to IGBT converter, heavy rms. current and very compact product is requested; film technology is able to achieve these 2 targets.

Products to offer

FFLI/FFLB	58 to 800 μ F	680 to 1900Vdc
FFVE	12 to 400 μ F	300 to 1900Vdc
FFVI	47 to 275 μ F	500 to 1100Vdc
FFB/FFV3	1.5 to 160 μ F	75 to 1100Vdc

WELDING

APPLICATIONS

Generate, out of the main supply, through a converter (chopper) and a transformer an overvoltage able to create an electrical arc.

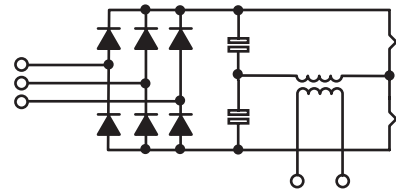
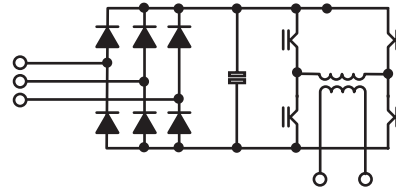

FUNCTION, PRODUCTS

DC Filtering

The purpose of this filter is to smooth the low frequency ripple coming from the rectifier (up to 360 Hz) and to filter the high frequency ripple coming from the converter (15/20 kHz).

Products to offer

FFVE	12 to 400 μ F	300 to 1900V
FFVI	47 to 275 μ F	500 to 1100V
FFB/FFV3	1.5 to 160 μ F	75 to 1100V

ELECTRICAL VEHICLE

APPLICATIONS

Battery powered car, electric fork lift truck and hybrid electric vehicle.

Due to high rms. current needed through the capacitor, metallized controlled self-healing technology will be an excellent solution.

See calculation example on page 58.

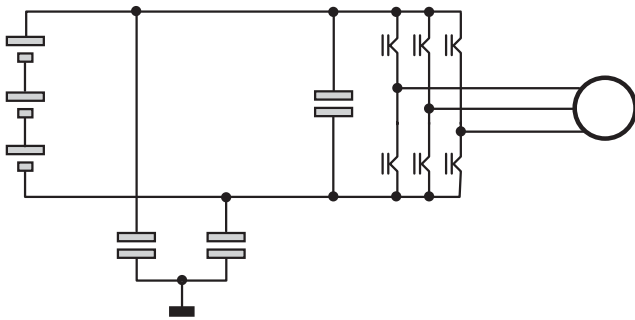

FUNCTION, PRODUCTS

DC Filtering

Between battery and converter, a capacitor is needed. Its main purpose is to filter the ripple coming from the converter, to avoid damaging the battery. Metallized Film Capacitors are able to fulfill this function using 2 or 3 cases (only electrolytic can not).

Products to offer

FFVE	12 to 400 μ F	300 to 1900Vdc
FFVI	47 to 275 μ F	500 to 1100Vdc

According to quantity, a custom design could be developed, achieving the total function with a single case.

WIND MILL

APPLICATIONS

Energy power supplied by the wind, new wind mill generation use electronic converter in order to control power, phase and voltage.

FUNCTION, PRODUCTS

DC Filtering

The purpose of the product is to filter voltage ripple. TPC has developed controlled self-healing range allowing reliable and competitive solution compare electrolytic technology.

See calculation example how to replace electrolytic technology on pages 58 and 59.

Products to offer

FFLC	1120 to 8800 μ F	up to 1200Vdc
-------------	----------------------	---------------

Protection of semi-conductors

Overvoltage and clamping due to switching of semi-conductors.

Products to offer

Snubbers	FSB	0.1 to 3 μ F	up to 2kVdc
Clamping	FFVE	12 to 400 μ F	up to 1.9kVdc

ENERGY STORAGE

APPLICATIONS

Medical: cardiac defibrillator
Industrial and military: laser telemetry, flash lamp

FUNCTION, PRODUCTS

DC Filtering

Stored energy is used to generate electrical pulse.

Products to offer

FDV1	5 to 80 μ F	1000 to 1700V
FDBB	70 to 150 μ F	1800 to 3000V*

*Specific FDBB can be offered with energy density over more than 1.5J per cc.

FILM TECHNOLOGY TO REPLACE ELECTROLYTIC TECHNOLOGY

ABSTRACT

Trend of industrial and traction market for power conversion is to replace electrolytic capacitors by film technology.

This trend is generated by many advantages that film technology is offering. Among these advantages, we have:

- *High rms. current capabilities up to 1Arms. per μ F
- *Overvoltage withstanding up to 2 times the rated voltage
- *Handle a reversal voltage
- *High peak current capabilities
- *No acid inside
- *Long lifetime
- *No storage problem

However, this replacement won't be done <<can for can>>, but for the function.

Indeed, despite the very big improvement of film technology, replacement solution won't be possible for each application, there will be several approaches to do this.

In order to help the user to see clear, we will present some concrete figures where film gives a major benefit instead of electrolytic technology.

Application Notes

1) DC LINK FILTER: HIGH CURRENT DESIGN & CAPACITANCE VALUE DESIGN

1a) Energy supplied with batteries

Applications will be: electric car
electric fork lift truck

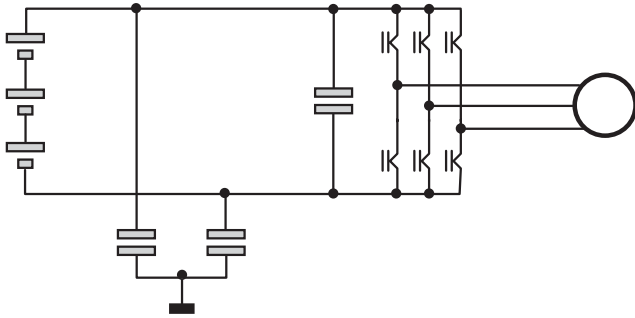

In that case, capacitor will be used as a decoupling capacitor. Film capacitor is particularly well adapted for this use, because main criteria for DC link capacitor will be rms. current withstanding.

It means that DC link capacitor can be designed on rms. current value.

If we take an electric car in account as example:

Requirement data:

Working voltage:	120Vdc
Ripple voltage allowed:	4Vrms
Rms. current:	80 Arms. @ 20kHz

Minimum capacitance value will be:

$$C = \frac{I_{rms}}{U_{ripple} \times 2 \times \pi \times f} = 159\mu F$$

So, it will be easy to find a capacitance value close to these values.

Comparison with electrolytic capacitor.

If we take in account 20mA per μF for example, in order to handle 80 Arms, capacitance value minimum would be:

$$C = \frac{80}{0.02} = 4000\mu F$$

1b) Industrial motor drive, energy supplied from supply network

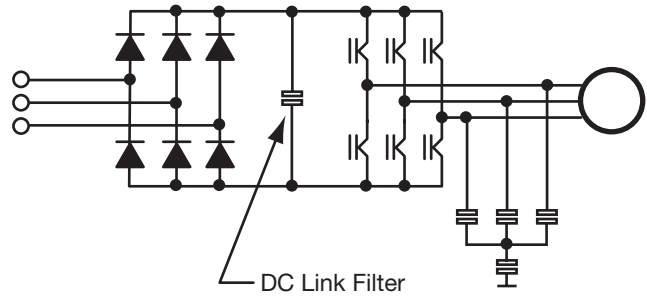

DC link voltage waveform:

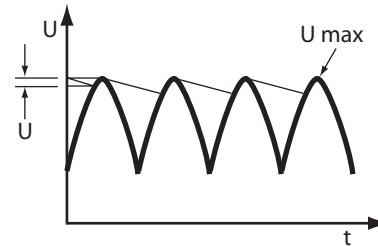

Capacitance value will be defined taken in account that supply frequency is lower than converter frequency.

To determine needed capacitance, we can use the following approached equation:

$$C = \frac{P_{load}}{U_{ripple} \times \left[U_{max} - \frac{U_{ripple}}{2} \right] \times F_{rectifier}}$$

Irms. through capacitor will be (approached expression):

Of course this current doesn't take in account frequency converter current.

$$I_{rms} = \frac{U_{ripple}}{2 \times \sqrt{2}} \times C \times 2 \times \pi \times F_{rectifier} = \frac{P_{load} \times \pi}{\left[U_{max} - \frac{U_{ripple}}{2} \right] \sqrt{2}}$$

So, with this approximation, Irms. through the capacitor will be depending of the Power of load, Umax and U ripple.

Application Notes

To illustrate, we will take a concrete example:

DC voltage 1000 Volts

U ripple 200 volts

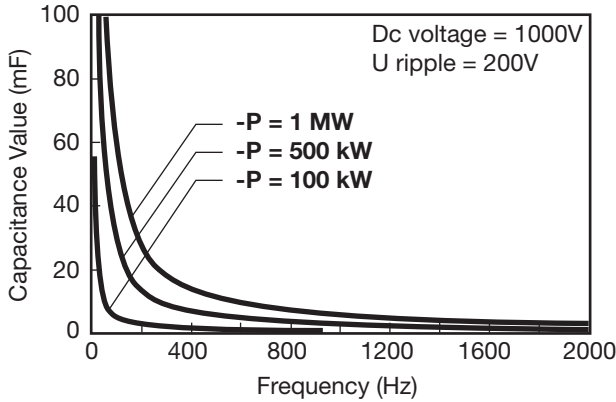

P	I _{rms}
1 MW	2468 Arms
500 kW	1234 Arms
100 kW	247 Arms

It becomes necessary to have a zoom on low frequency:

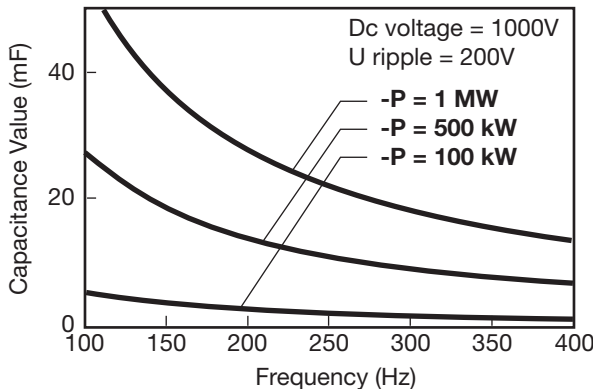

To compare with electrolytic solution, we will take a current capability of 20mA per μF for electrolytic capacitors. First case, power at 1Mwatt:

Rms. current is 2468 Arms, which would impose minimum capacitance value of 123.4mF (taken in account 0.2Arms. per μF).

If we look at this value on the curve, we can see that this capacitance value is needed (the given example for film technology) for a rectifier frequency lower than 100Hz.

So, with 3 phases, 6 diodes rectifier, frequency will be 300Hz.

We can see on 1 megawatt curve that capacitance needed is 18.5mF. Film solution will be almost 4 times smaller than electrolytic solution, with high reliability in addition.

Lower power will give similar results, and for power up to 10 kwatts, capacitance value becomes so small that film technology still constitutes the best solution.

Even at 100Hz rectifier frequency, no more than 555 μF are needed, supply voltage and ripple still the same than previously.

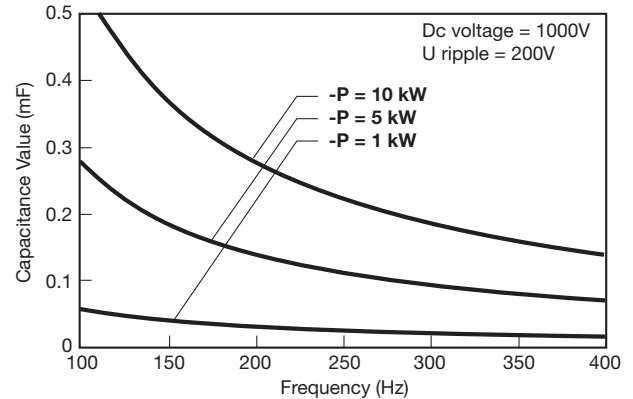

2) OVERVOLTAGE DESIGN

We will consider light traction application, like metro, tramway, electric buses, ...

DC link voltage wave form:

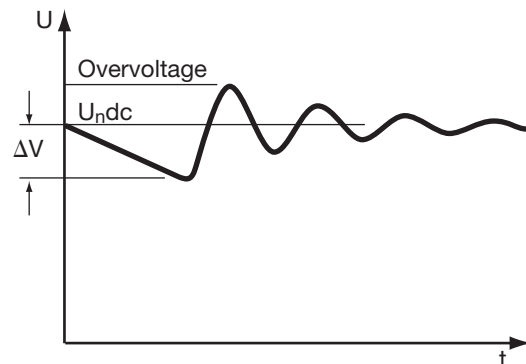
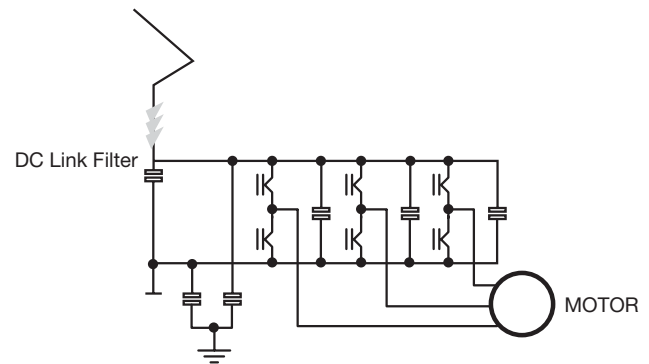

Application Notes

Due to the principle of carrying the power from the catenary to the train, some contact discontinuity appears between pantograph and catenary.

When contact is not done, energy come from DC link filter, with for effect, to decrease the voltage. So, as soon as the contact is re-established, an overvoltage appears.

$$V(t) = U_{ndc} - \Delta V \times e^{-\alpha t} \times \left(\cos \omega t + \frac{\alpha}{\omega} \sin \omega t \right)$$

$$\text{with } \omega = \sqrt{\beta_0^2 - \alpha^2}$$

$$\beta_0 = \frac{1}{\sqrt{L \times C}}$$

$$\alpha = \frac{R}{2 \times L}$$

Worse case would be $\Delta V =$ catenary voltage, because overvoltage could almost reach 2 times the rated voltage.

So, film capacitor can handle this kind of overvoltage.

Comparison with electrolytic technology:

Electrolytic handle 1.2 DC voltage max:

So minimum voltage that electrolytic should handle would be:

$$\text{DC voltage of electrolytic technology: } \frac{2 \times 1000V}{1.2} = 1670V$$

4 capacitors 450 Volts in series would be needed.

Volume occupied for 10mF with electrolytic would be: 26 l and Irms. max would be 220Arms.

With film, volume occupied would be 25 l, and rms. current capability would be higher than 500Arms.

In other hand, link to these overvoltages, peak current appear through the capacitor:

So, we have to calculate the energy generated by this overvoltage $I^2t = \int i^2(t)dt$.

$$i(t) = \frac{C\beta_0^2 V_0}{\omega} e^{-\alpha t} \sin \omega t$$

$$i^2(t) = \frac{C^2 \beta_0^4 V_0^2}{\omega^2} e^{-2\alpha t} \sin^2 \omega t$$

$$\int_0^{\infty} i^2(t)dt = \left[\frac{1}{4} \frac{e^{-2\alpha t} C^2 \beta_0^4 V_0^2 (-\alpha^2 - \omega^2 + \alpha^2 \cos 2\omega t - \alpha \omega \sin 2\omega t)}{\alpha \omega^2 (\alpha^2 + \omega^2)} \right]_0^{\infty}$$

After few periods, current becomes null, then:

$$\int_0^{\infty} i^2(t)dt = [0] - \left[-\frac{1}{4} \frac{C^2 \beta_0^4 V_0^2}{\alpha (\alpha^2 + \omega^2)} \right] = \frac{1}{4} \frac{C^2 \beta_0^4 V_0^2}{\alpha (\alpha^2 + \omega^2)}$$

$$\text{with: } \beta_0 = \frac{1}{\sqrt{L \times C}}; \alpha = \frac{R}{2 \times L}; \omega = \sqrt{\beta_0^2 - \alpha^2}$$

This energy calculation will be used for short circuit discharge between terminal as well. Such discharge will generate a very high peak current and some ringing that electrolytic could not handle.

3) VOLTAGE RATING

Function of the voltage rating needed, film solution will become more and more interesting.

If high capacitance value is requested, film solution will be less competitive. Indeed, if there is no overvoltage, low rms. current, large capacitance value, it will be difficult for film technology to be competitive below 900 volts.

LIFETIME CALCULATION

Film technology allows a very long lifetime expectancy, depending on voltage load conditions (working voltage) and hot spot temperature.

For DC filtering, lifetime meets the curves shown in this catalog.

End of life criteria is a decrease of capacitance value of 2%. However, this is a theoretical end of life, because capacitor can be still used after this point. If application can allow 5% capacitance decrease, lifetime will be widely increased.

Hot spot temperature will be determined with the following expression:

$$\theta_{max_{hotspot}} = \theta_{ambient} + I_{rms}^2 \times \left[r_s + \frac{1}{C \times 2 \times \pi} \times tg\delta_0 \right] \times R_{th}$$

with: $\theta_{max_{hotspot}}$: the maximum hot spot temperature

$tg\delta_0$: dielectric losses

R_{th} : Thermal resistance

r_s : Serial resistance

$\theta_{hot spot}$ will be 85°C or 105°C function of the application and the technology.

4) CONCLUSION

This document gives some ways for the engineer designer to do their choice. Of course, for each case a complete calculation will have to be done.

Anyway, if the request is only capacitance value, low voltage, low rms. Current, no overvoltage, no reversal voltage, no peak current, film technology certainly won't be a good solution.

Medium Power Film Capacitors



Worksheet for Custom Requirements

Company _____
Name _____ Phone Number _____
Department _____ Fax Number _____
Address _____ E-mail _____

ELECTRICAL CHARACTERISTICS

Applications	DC Filtering	Protection*	Tuning
Capacitance (C)	_____ uF	_____ uF	_____ uF
Tolerance (%)	_____ %	_____ %	_____ %
Operating Voltage	_____ Vdc	_____ Vpk / _____ Vdc*	_____ Vrms
Ripple Voltage	_____ Vr		
Working Frequency (f)	_____ Hz		_____ Hz
Operating Current (Irms)	_____ Irms	_____ Irms	_____ Irms
Maximum Current (Imax)	_____ Imax		
Maximum Peak Current (Ipeak)	_____ Ipk	_____ Ipk	
Maximum Inductance (Ls)	_____ nH	_____ nH	_____ nH
Test voltage between terminals	_____ V	_____ V	_____ V
Maximum surge voltages (MSV)	_____ V	_____ V	
MSV duration / frequency	_____ s _____ / year	_____ s _____ / year	

* - Due to the particularities of varying waveforms in such applications more information on the exact nature of waveforms is generally required for a full analysis.

THERMAL CHARACTERISTICS

Storage temp. ____ min ____ avg ____ max (C) Operating Temp ____ min ____ avg ____ max (C)
Cooling Method (check one) - Natural Convection ____ Forced Air ____ Water ____
Dimensions / shape (please indicate in. / mm.) _____
and type of bushings _____ Environment _____
Operating Position: (circle one) (vertical / horizontal / inclined / other _____)

Other information / drawing / block diagram of circuit:

Please send this to your local AVX representative.

USA

AVX Myrtle Beach, SC
Corporate Offices
Tel: 843-448-9411
FAX: 843-448-1943

AVX North Central, IN
Tel: 317-848-7153
FAX: 317-844-9314

AVX Southwest, AZ
Tel: 602-678-0384
FAX: 602-678-0385

AVX Southeast, GA
Tel: 404-608-8151
FAX: 770-972-0766

AVX Northwest, WA
Tel: 360-699-8746
FAX: 360-699-8751

AVX Mid/Pacific, CA
Tel: 510-661-4100
FAX: 510-661-4101

AVX South Central, TX
Tel: 972-669-1223
FAX: 972-669-2090

AVX Canada
Tel: 905-238-3151
FAX: 905-238-0319

EUROPE

AVX Limited, England
European Headquarters
Tel: ++44 (0) 1252-770000
FAX: ++44 (0) 1252-770001

AVX/ELCO, England
Tel: ++44 (0) 1638-675000
FAX: ++44 (0) 1638-675002

AVX S.A., France
Tel: ++33 (1) 69-18-46-00
FAX: ++33 (1) 69-28-73-87

AVX GmbH, Germany
Tel: ++49 (0) 8131-9004-0
FAX: ++49 (0) 8131-9004-44

AVX srl, Italy
Tel: ++390 (0)2 614-571
FAX: ++390 (0)2 614-2576

AVX Czech Republic
Tel: ++420 465-358-111
FAX: ++420 465-323-010

ASIA-PACIFIC

AVX/Kyocera, Singapore
Asia-Pacific Headquarters
Tel: (65) 6286-7555
FAX: (65) 6488-9880

AVX/Kyocera, Hong Kong
Tel: (852) 2-363-3303
FAX: (852) 2-765-8185

AVX/Kyocera, Korea
Tel: (82) 2-785-6504
FAX: (82) 2-784-5411

AVX/Kyocera, Taiwan
Tel: (886) 2-2698-8778
FAX: (886) 2-2698-8777

AVX/Kyocera, Malaysia
Tel: (60) 4-228-1190
FAX: (60) 4-228-1196

Elco, Japan
Tel: 045-943-2906/7
FAX: 045-943-2910

Kyocera, Japan - AVX
Tel: (81) 75-604-3426
FAX: (81) 75-604-3425

Kyocera, Japan - KDP
Tel: (81) 75-604-3424
FAX: (81) 75-604-3425

AVX/Kyocera, Shanghai, China
Tel: 86-21 6341 0300
FAX: 86-21 6341 0330

AVX/Kyocera, Tianjin, China
Tel: 86-22 2576 0098
FAX: 86-22 2576 0096

Contact:

