



## DESCRIPTION

The M271 is a bi-directional, single-pole, single-throw, normally open multipurpose solid-state relay in a miniature 4-pin small outline package. It is designed to be a cost-effective replacement of reed relays in low voltage applications. The relay consists of an integrated circuit that drives two rugged source-to-source enhancement type DMOS transistors - optically coupled to a light emitting diode. The output MOS transistors are protected with free-wheeling diodes that can handle up to 1.5A of inrush current, making the relay ideal for switching lamps and highly inductive loads.

## FEATURES

- Ultra miniature 4-pin small outline package
- Low input control power consumption (3mA TYP)
- 10 ohms maximum on-resistance
- 60V load voltage rating
- 125mA maximum continuous load current
- High input-to-output isolation (1500V MIN)
- Long life/high reliability

## OPTIONS/SUFFIXES\*

- -TR Tape and Reel

NOTE: Suffixes listed above are not included in marking on device for part number identification.

## SCHEMATIC DIAGRAM

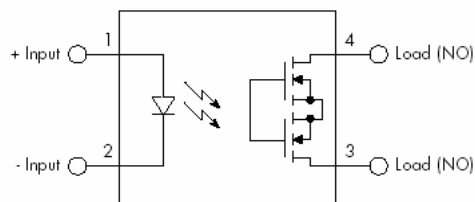

## APPLICATIONS

- Reed relay replacement
- Meter reading systems
- Medical equipment
- Battery monitoring
- Multiplexers

## ABSOLUTE MAXIMUM RATINGS\*

PARAMETER	UNIT	MIN	TYP	MAX
Storage Temperature	°C	-55		125
Operating Temperature	°C	-40		85
Continuous Forward Current	mA			50
Peak Forward Current (1us)	A			1
Reverse Input Control Voltage	V			5
Output Power Dissipation	mW			400

\*The values indicated are absolute stress ratings. Functional operation of the device is not implied at these or any conditions in excess of those defined in electrical characteristics section of this document. Exposure to Absolute Ratings may cause permanent damage to the device and may adversely affect reliability.

## APPROVALS

- UL / C-UL Approved (File # E201932)

**ELECTRICAL CHARACTERISTICS - 25°C**

PARAMETER	UNIT	MIN	TYP	MAX	TEST CONDITIONS
<b>INPUT SPECIFICATIONS</b>					
LED Forward Voltage	V		1.2	1.5	If = 10mA
LED Reverse Voltage	V	6	12		Ir = 10uA
Turn-On Current	m A		3	5	Vo = 20V, Io = 100mA, t = 10ms
Turn-Off Current	m A		0.5	5	Vo = 20V, Io = <5uA
<b>OUTPUT SPECIFICATIONS</b>					
Blocking Voltage	V	60			Io = 1uA
Continuous Load Current	m A			125	If = 5mA
On-Resistance	Ω		7	10	Io = 100mA
Leakage Current	μ A		0.2	1	Vo = 60V
Output Capacitance	p F		25	50	Vo = 25V, f = 1.0MHz
Offset Voltage	m V			0.2	If = 5mA
<b>COUPLED SPECIFICATIONS</b>					
Isolation Voltage	V	1500			T = 1 minute
Turn-On Time	m s		0.5	2	If = 10mA, Io = 100mA, Vo = 20V
Turn-Off Time	m s		0.2	2	If = 10mA, Io = 100mA, Vo = 20V
Isolation Resistance	G Ω	100			
Coupled Capacitance	p F		3		
Contact Transient Ratio	V / μ s	2000	7000		dV = 50V

**PERFORMANCE DATA**

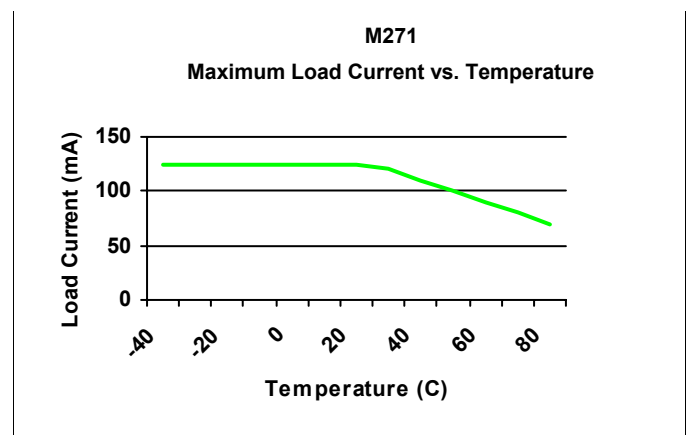
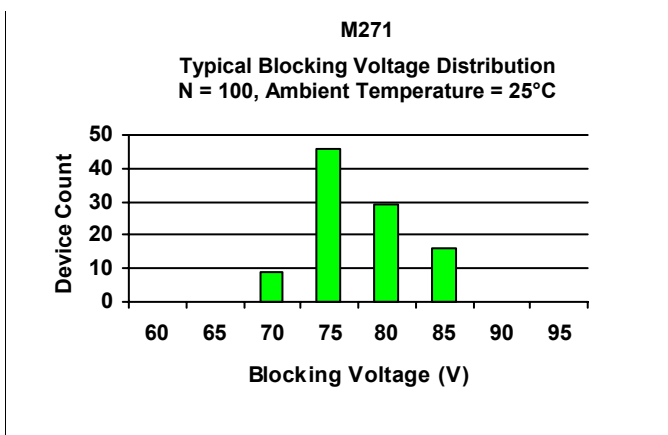
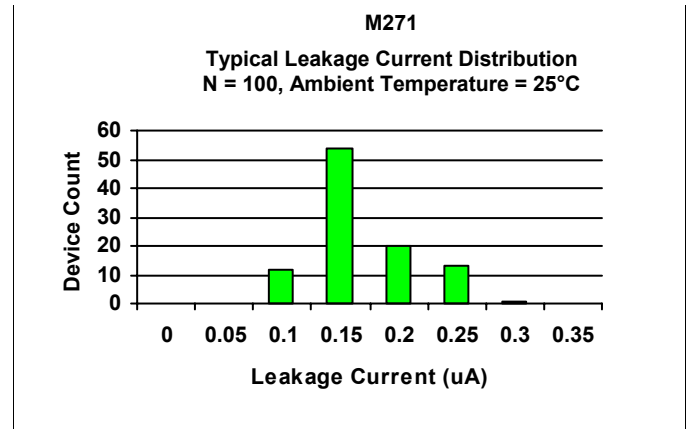
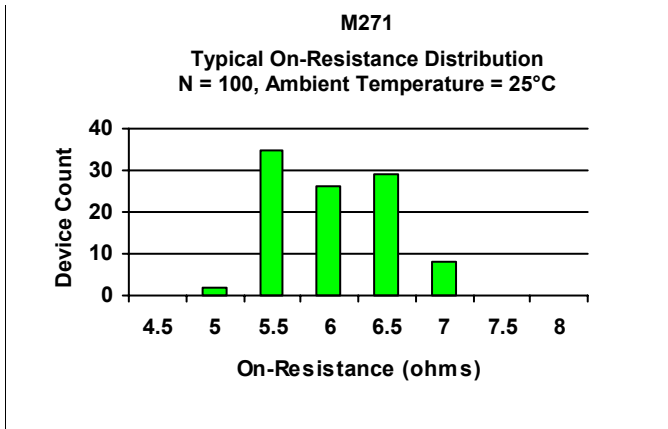
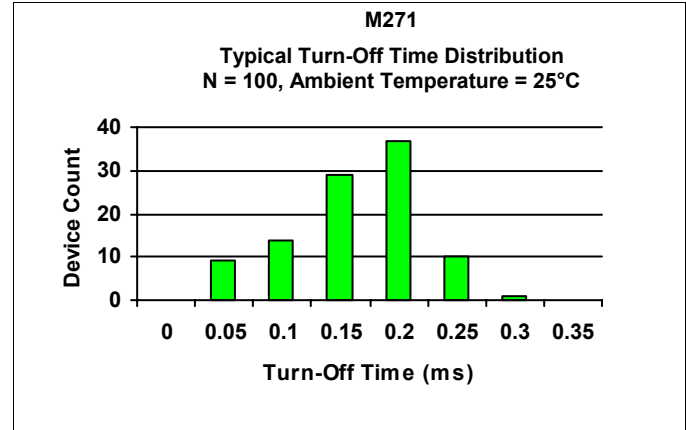
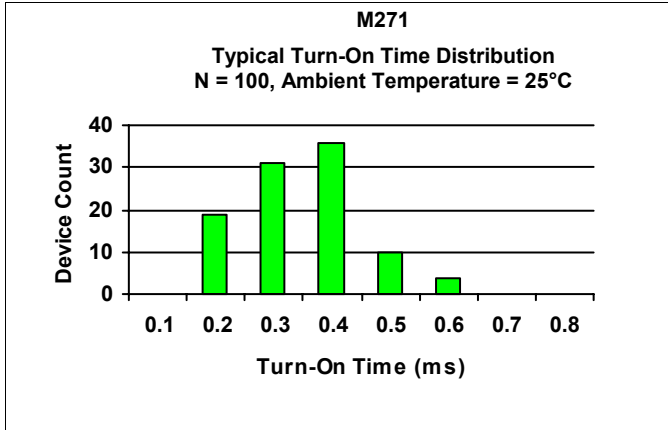

**MECHANICAL DIMENSIONS**

**4 PIN SMALL OUTLINE PACKAGE**

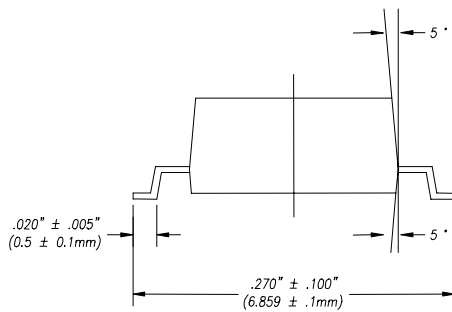

**END VIEW**

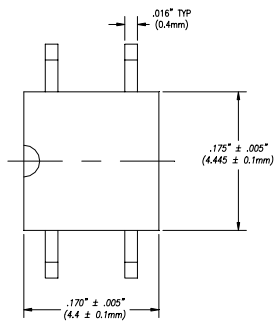

**TOP VIEW**

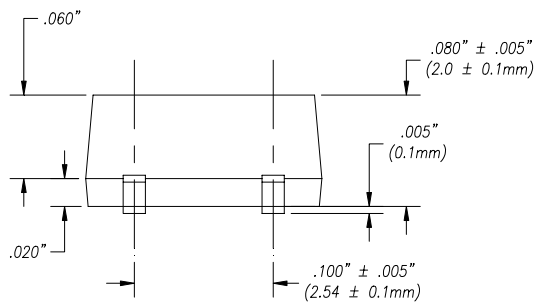

**BACK VIEW**

## **DISCLAIMER**

---

*Solid State Optronics (SSO) makes no warranties or representations with regards to the completeness and accuracy of this document. SSO reserves the right to make changes to product description, specifications at any time without further notice. SSO shall not assume any liability arising out of the application or use of any product or circuit described herein. Neither circuit patent licenses nor indemnity are expressed or implied. Except as specified in SSO's Standard Terms & Conditions, SSO disclaims liability for consequential or other damage, and we make no other warranty, expressed or implied, including merchantability and fitness for particular use.*

## **LIFE SUPPORT POLICY**

---

*SSO does not authorize use of its devices in life support applications wherein failure or malfunction of a device may lead to personal injury or death. Users of SSO devices in life support applications assume all risks of such use and agree to indemnify SSO against any and all damages resulting from such use. Life support devices are defined as devices or systems which, (a) are intended for surgical implant into the body, or (b) support or sustain life, and (c) whose failure to perform when used properly in accordance with instructions for use can be reasonably expected to result in significant injury to the user, or (d) a critical component in any component of a life support device or system whose failure can be reasonably expected to cause failure of the life support device or system, or to affect its safety or effectiveness.*