

HIGH PERFORMANCE TRIACS

FEATURES

$I_{T(RMS)} = 4\text{ A}$
 $V_{DRM} = 400\text{ V to }600\text{ V}$
 SENSITIVE GATE : $I_{GT} \leq 5\text{ mA}$
 LOGIC LEVEL
 HIGH NOISE IMMUNITY

DESCRIPTION

The T405-B triac is using a high performance TOP-GLASS PNP technology. This device is intended for AC control applications using surface mount technology. The high commutation performances combined with high sensitivity make this triac perfect for direct drive from microprocessors in all applications like appliances, power tools, small motor drives etc...

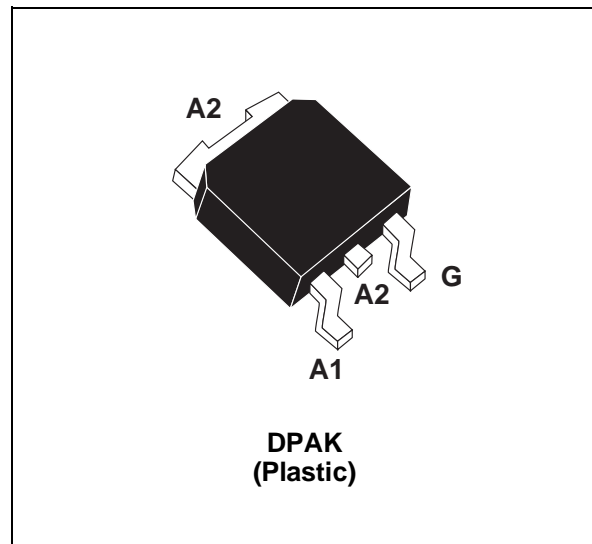

ABSOLUT MAXIMUM RATINGS

Symbol	Parameter	Value	Unit
$I_{T(RMS)}$	RMS on-state current (360° conduction angle)	$T_c = 95\text{ °C}$ 4	A
I_{TSM}	Non repetitive surge peak on-state current (T_j initial = 25°C)	$t_p = 8.3\text{ ms}$	35
		$t_p = 10\text{ ms}$	30
I^2t	I^2t value for fusing	$t_p = 10\text{ ms}$ 4.5	A ² s
di/dt	Critical rate of rise of on-state current $I_G = 50\text{ mA}$ $di_G/dt = 0.1\text{ A}/\mu\text{s}$	Repetitive $F = 50\text{ Hz}$	10
		Non Repetitive	50
T_{stg} T_j	Storage temperature range Operating junction temperature range	- 40 to + 150 - 40 to + 110	°C °C
TI	Maximum lead temperature for soldering during 10 s	260	°C

Symbol	Parameter	T405-		Unit
		400B	600B	
V_{DRM} V_{RRM}	Repetitive peak off-state voltage $T_j = 110\text{ °C}$	400	600	V

T405-B

THERMAL RESISTANCES

Symbol	Parameter	Value	Unit
Rth (j-c)	Junction to case for DC	3.5	°C/W
Rth (j-c)	Junction to case for AC 360° conduction angle (F= 50 Hz)	2.6	°C/W

GATE CHARACTERISTICS (maximum values)

$P_{G(AV)} = 1 \text{ W}$ $P_{GM} = 10 \text{ W}$ ($t_p = 20 \mu\text{s}$) $I_{GM} = 4 \text{ A}$ ($t_p = 20 \mu\text{s}$) $V_{GM} = 16 \text{ V}$ ($t_p = 20 \mu\text{s}$).

ELECTRICAL CHARACTERISTICS

Symbol	Test Conditions		Quadrant		Value	Unit
I_{GT}	$V_D=12\text{V}$ (DC) $R_L=33\Omega$	$T_j=25^\circ\text{C}$	I-II-III	MAX	5	mA
V_{GT}	$V_D=12\text{V}$ (DC) $R_L=33\Omega$	$T_j=25^\circ\text{C}$	I-II-III	MAX	1.5	V
V_{GD}	$V_D=V_{DRM}$ $R_L=3.3\text{k}\Omega$	$T_j=110^\circ\text{C}$	I-II-III	MIN	0.2	V
tgt	$V_D=V_{DRM}$ $I_G = 40\text{mA}$ $dI_G/dt = 0.5\text{A}/\mu\text{s}$ $I_{TM} = 5.5\text{A}$	$T_j=25^\circ\text{C}$	I-II-III	TYP	2	μs
I_L	$I_G=1.2 I_{GT}$	$T_j=25^\circ\text{C}$	I-II-III	MAX	15	mA
I_H *	$I_T= 100\text{mA}$ gate open	$T_j=25^\circ\text{C}$		MAX	10	mA
V_{TM} *	$I_{TM}= 5.5\text{A}$ $t_p= 380\mu\text{s}$	$T_j=25^\circ\text{C}$		MAX	1.75	V
I_{DRM} I_{RRM}	V_{DRM} Rated V_{RRM} Rated	$T_j=25^\circ\text{C}$		MAX	10	μA
		$T_j=110^\circ\text{C}$		MAX	2	mA
dV/dt *	Linear slope up to $V_D=67\%V_{DRM}$ gate open	$T_j=110^\circ\text{C}$		MIN	5	V/ μs
				TYP	20	
$(dI/dt)_c$ *	$(dV/dt)_c = 0.1\text{V}/\mu\text{s}$	$T_j=110^\circ\text{C}$		MIN	1.8	A/ms

* For either polarity of electrode A₂ voltage with reference enceenceto electrode A₁.

Fig. 1: Maximum power dissipation versus rms on-state current.

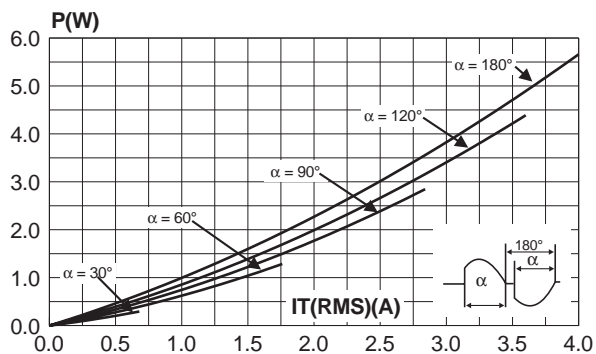

Fig. 2: Correlation between maximum power dissipation and maximum allowable temperatures (T_{amb} and T_{case}) for different thermal resistances heatsink+contact.

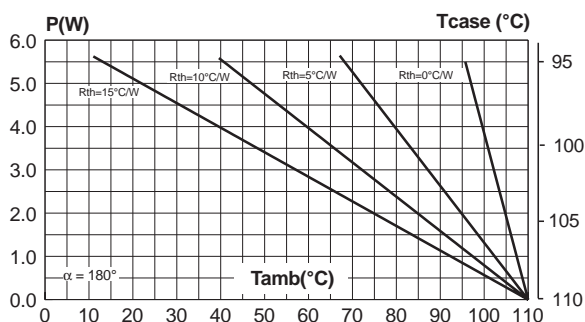

Fig. 3: RMS on-state current versus ambient temperature.

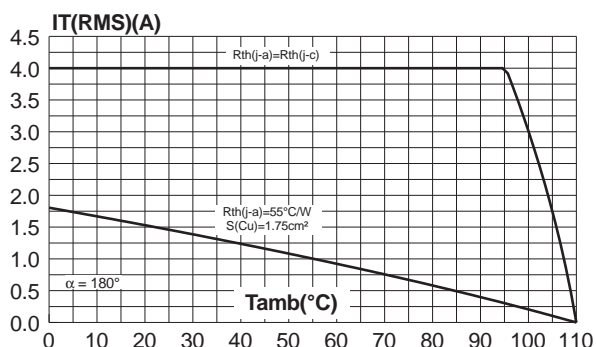

Fig. 4: Relative variation of thermal impedance junction to case versus pulse duration.

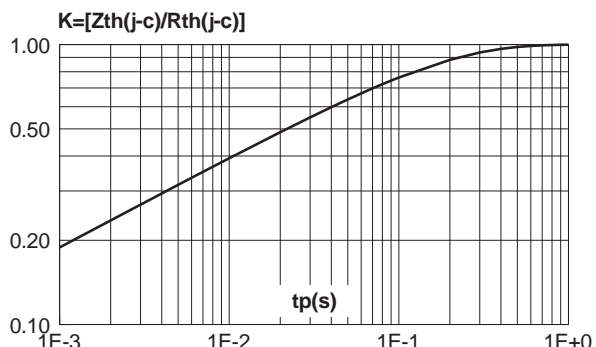

Fig. 5: Relative variation of gate trigger current and holding current versus junction temperature (typical values).

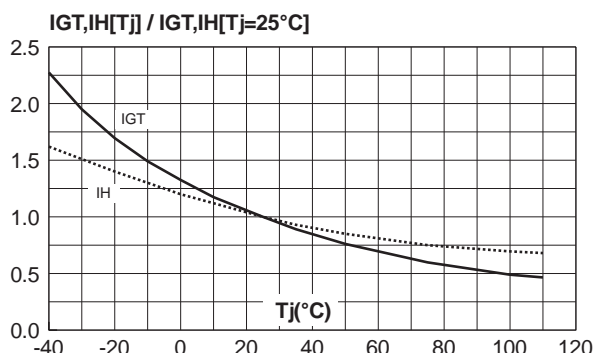
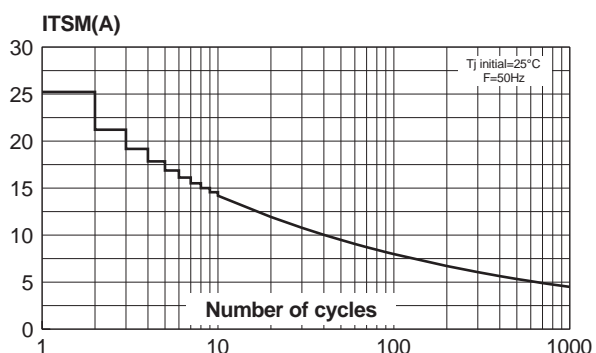

Fig. 6: Non repetitive surge peak on-state current versus number of cycles.



T405-B

Fig. 7: Non repetitive surge peak on-state current for a sinusoidal pulse with width $t_p < 10\text{ms}$, and corresponding value of I_2t .

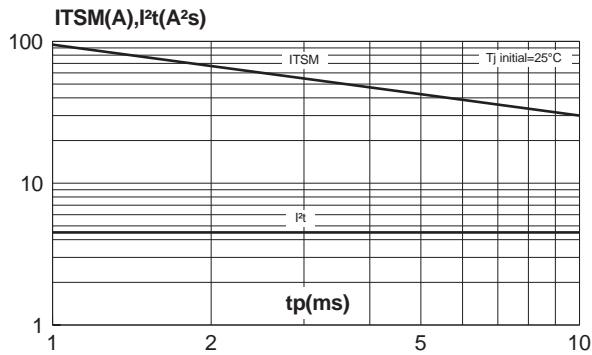

Fig. 8: On-state characteristics (maximum values).

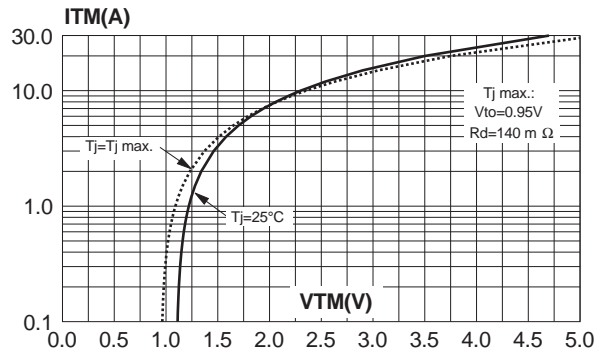
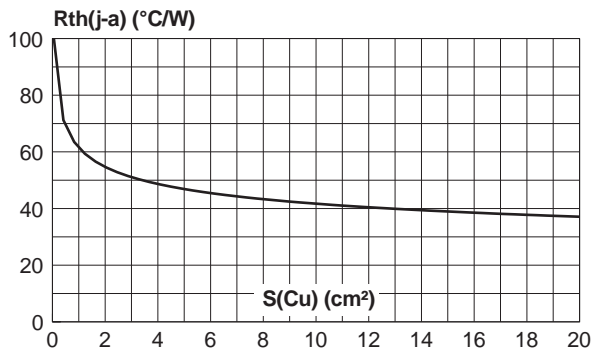
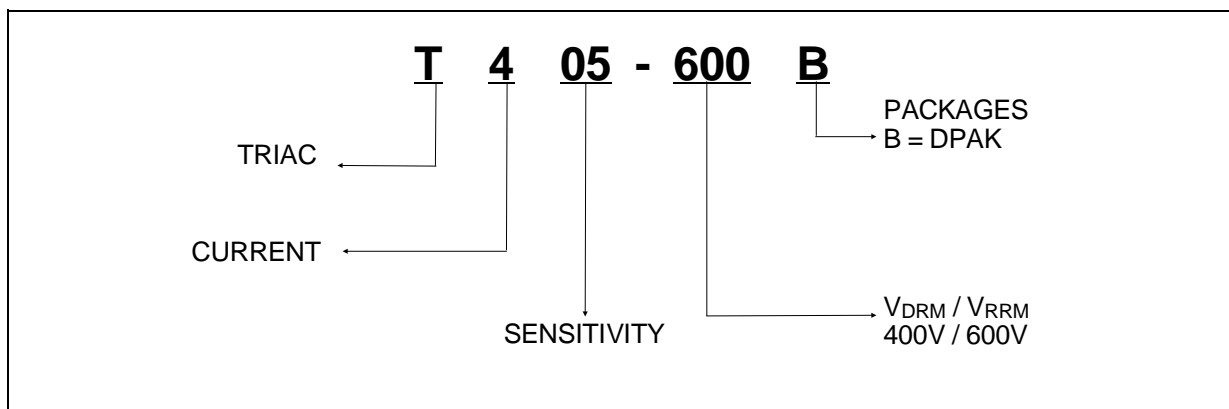
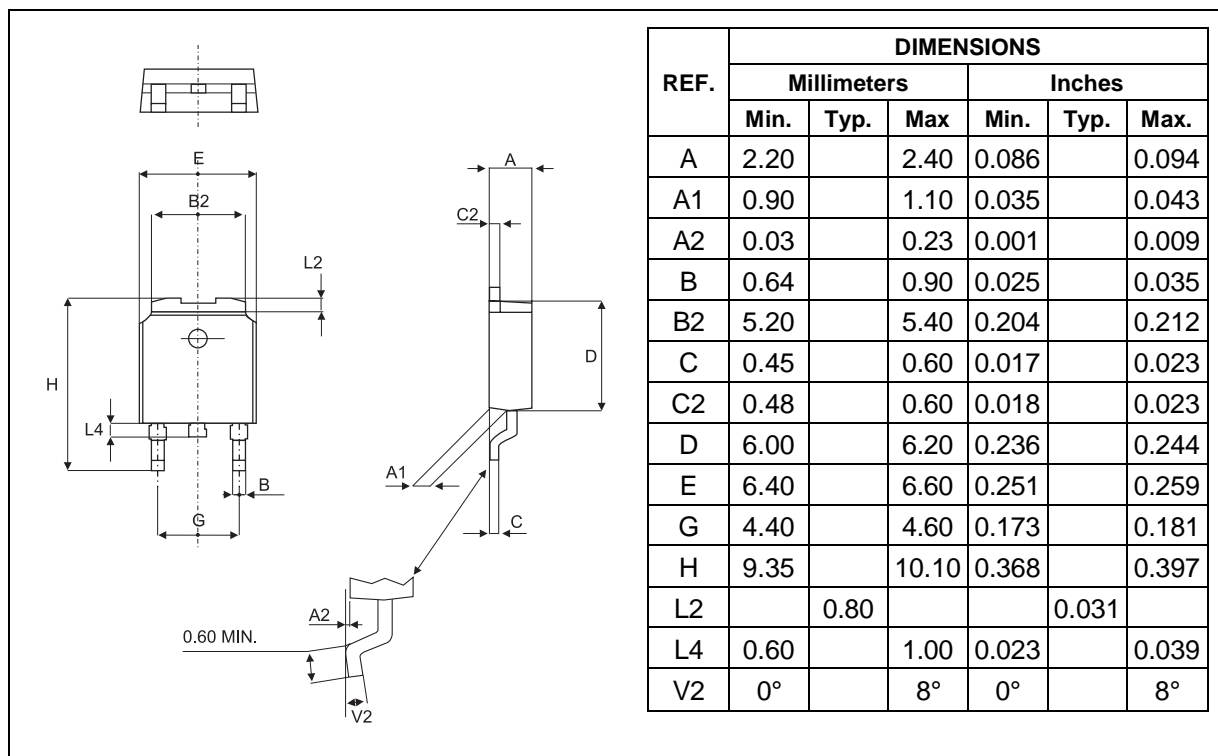
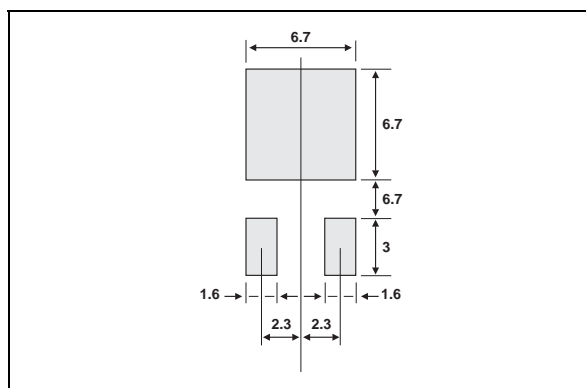

Fig. 9: Thermal resistance junction to ambient versus copper surface under tab (Epoxy printed circuit board FR4, copper thickness: 35 μm).



ORDERING INFORMATION



PACKAGE MECHANICAL DATA
 DPAK Plastic

FOOT PRINT DIMENSIONS (in millimeters)

MARKING

TYPE	MARKING
T405-400B	T4 0540
T405-600B	T4 0560

WEIGHT : 0.30g

Information furnished is believed to be accurate and reliable. However, STMicroelectronics assumes no responsibility for the consequences of use of such information nor for any infringement of patents or other rights of third parties which may result from its use. No license is granted by implication or otherwise under any patent or patent rights of STMicroelectronics. Specifications mentioned in this publication are subject to change without notice. This publication supersedes and replaces all information previously supplied. STMicroelectronics products are not authorized for use as critical components in life support devices or systems without express written approval of STMicroelectronics.

The ST logo is a registered trademark of STMicroelectronics

© 1999 STMicroelectronics - Printed in Italy - All rights reserved.

STMicroelectronics GROUP OF COMPANIES

 Australia - Brazil - Canada - China - France - Germany - Italy - Japan - Korea - Malaysia - Malta - Mexico - Morocco -
 The Netherlands - Singapore - Spain - Sweden - Switzerland - Taiwan - Thailand - United Kingdom - U.S.A.

<http://www.st.com>