

T-25-17

TENTATIVE DATA

FEATURES
Low loss asymmetrical diffusion structure.
Interdigitated gate structure.
Very low TQ with gate assisted turn-off.
Fully characterised for operation up to 40 kHz.
Directly compatible with 220-415 V a.c. mains.

APPLICATIONS
High frequency, high power choppers and inverters :
Welding, Induction Heating, 400 Hz UPS,
PWM inverters, Ultrasonic generators.

CARACTERISTIQUES GENERALES
*Structure de diffusion asymétrique à faibles pertes.
Structure de gâchette amplificatrice.
Très faible TQ avec l'extinction assistée par gâchette.
Caractérisé pour fonctionnement jusqu'à 40 kHz.
Compatible avec tensions secteur 220-415 V.*

APPLICATIONS
*Hacheurs et onduleurs haute fréquence, forte puissance :
Soudure, Chauffage par induction,
Onduleurs MLI, Générateurs ultrason, Alimentations de secours 400 Hz.*

IT(PEAK)@ 20 KHz **40 Amps**

VDRM up to **1200 Volts**

tq' **5 µs**

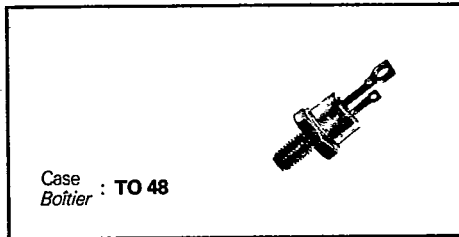

ORDERING INFORMATION APPELLATION				
Type	Voltage		Turn - off	
Code	V _{DRM} (V)	Code	t _{q'} (µs)	Code
TSD	50	035	5	No code
	200	235		
	400	435		
	600	635		
	800	835		
	1000	1035		
	1200	1235	For V _{DRM} ≥ 1000 V, please consult us. Pour V _{DRM} ≥ 1000 V, nous consulter.	

Example Type TSD with V _{DRM} = 600 V, and tq' = 5 µs, order as:	Type	V _{DRM}
	TSD	635

September 1983 - 1/6

BLOCKING STATE CHARACTERISTICS

Repetitive peak reverse voltage (for all voltage classes)	V_{RRM}	10	V	
Max. forward leakage current	I_{DRM}	5	mA	$T_J = 125\text{ }^\circ\text{C}$ @ V_{DRM}
Max. reverse leakage current	I_{RRM}	100	mA	$T_J = 125\text{ }^\circ\text{C}$ @ V_{RRM}

CONDUCTING STATE CHARACTERISTICS

Peak forward current at 20 kHz	$I_{T(PEAK)}$	40	A	} $T_J = 125\text{ }^\circ\text{C}$ $T_{case} = 80\text{ }^\circ\text{C}$ Half sine Duty cycle 50 Hz
Peak one cycle surge current (non repetitive)	I_{TSM}	400	A	
I^2t (for fusing)	I^2t	800	A ² s	$T_J = 125\text{ }^\circ\text{C}$ $t_p = 10\text{ ms}$ $V_R = 0$
Max. forward voltage drop	V_{TM}	2.4	V	$T_p \geq 10\text{ ms}$ $T_J = 25\text{ }^\circ\text{C}$ $I_{TM} = 100\text{ A}$

SWITCHING CHARACTERISTICS

Gate assisted turn-off time (with feedback diode)	t_q Max Typ	5 3	μs	} $T_J = 125\text{ }^\circ\text{C}$ $I_{TM} = 40\text{ A}$ $t_p = 25\text{ }\mu\text{s}$ $di_R/dt = 10\text{ A}/\mu\text{s}$ $V_R = -1\text{ V}$ $dv/dt = 200\text{ V}/\mu\text{s}$ (Linear to $0.6 V_{DRM}$) $V_{GK} = -5\text{ V}$
Typ. turn-off time (with feedback diode)	t_q	7	μs	
Min. critical on-state di/dt - Non repetitive - Repetitive	di/dt	1000 500	A/ μs	$T_J = 125\text{ }^\circ\text{C}$ $I_{TM} = 40\text{ A}$ $t_p = 100\text{ }\mu\text{s}$ $di_R/dt = 10\text{ A}/\mu\text{s}$ $V_R = 1\text{ V}$ $dv/dt = 200\text{ V}/\mu\text{s}$ (Linear to $0.6 V_{DRM}$) Gate open
Min. critical off-state dv/dt	dv/dt	1000	V/ μs	Gate supply $20\text{ V}/20\text{ }\Omega$ $t_r \leq 0.5\text{ }\mu\text{s}$ $T_J = 125\text{ }^\circ\text{C}$ Linear to $0.6 V_{DRM}$ $V_{GK} = -5\text{ V}$

GATE CHARACTERISTICS

Max. DC trigger current	I_{GT}	200	mA	} $T_J = 25\text{ }^\circ\text{C}$ $V_D = 12\text{ V}$ $R_L = 3\text{ }\Omega$
Max. DC trigger voltage	V_{GT}	2	V	
Min. non trigger voltage	V_{GD}	0.2	V	$T_J = 125\text{ }^\circ\text{C}$ $V_D = V_{DRM}$ $R_L = 1\text{ k}\Omega$
Peak forward current	I_{FGM}	20	A	$T_p = 10\text{ }\mu\text{s}$
Peak reverse voltage	V_{RGM}	10	V	
Peak power	P_{GM}	60	W	$T_p = 10\text{ }\mu\text{s}$
Average power	$P_{G(AV)}$	2	W	

THERMAL AND MECHANICAL CHARACTERISTICS

Junction operating temperature range	T_J	- 40 to + 125	$^\circ\text{C}$	
Storage temperature range	T_{stg}	- 40 to + 150	$^\circ\text{C}$	
Max. thermal resistance junction to case (DC)	R_{thJC}	1.0	$^\circ\text{C}/\text{W}$	Stud torque Min : 3.5 Nm Max : 3.8 Nm
Max. thermal resistance case to heatsink	R_{thCS}	0.4		

SINUSOIDAL CURRENT PULSE DATA

T-25-17

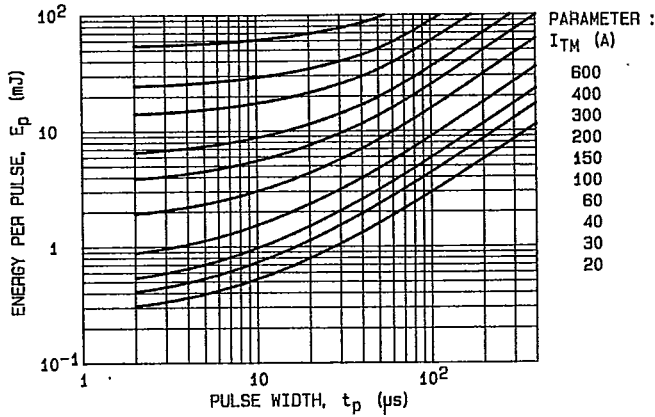

FIG.1 - ENERGY PER PULSE FOR SINUSOIDAL PULSES.

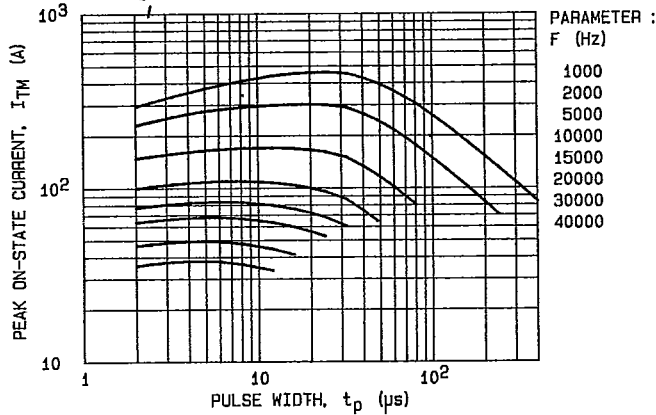

FIG.2 - MAXIMUM ALLOWABLE PEAK ON-STATE CURRENT VERSUS PULSE WIDTH FOR $T_c = 85^\circ\text{C}$.

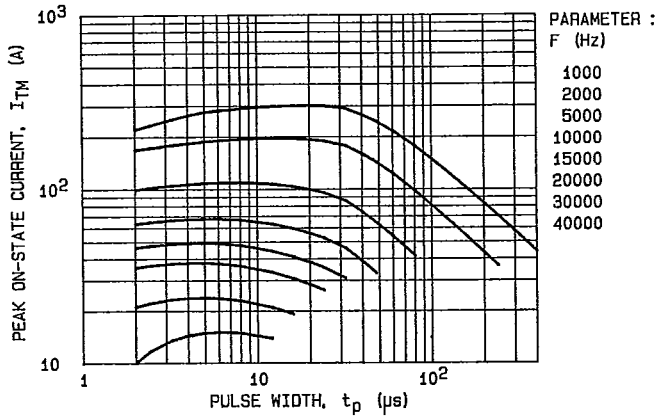
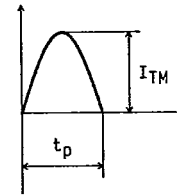

FIG.3 - MAXIMUM ALLOWABLE PEAK ON-STATE CURRENT VERSUS PULSE WIDTH FOR $T_c = 90^\circ\text{C}$.



NOTES :

1. $V_D \leq 600$ Volts.
2. $V_R \leq 1$ Volt.
3. R.C Snubber, $C = 22$ nF,
 $R = 33 \Omega$

TRAPEZOIDAL CURRENT PULSE DATA

T-25-17

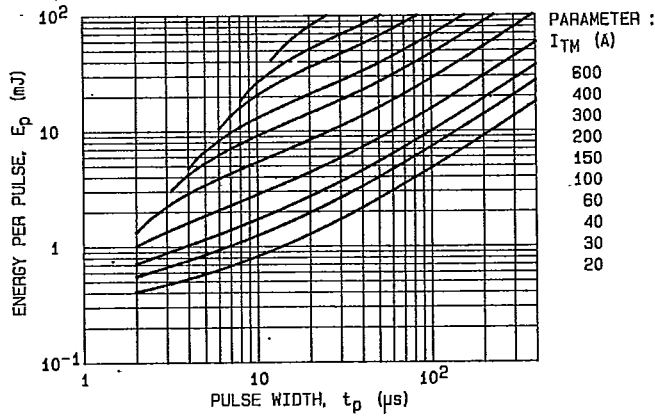

FIG.4 - ENERGY PER PULSE FOR TRAPEZOIDAL PULSES.

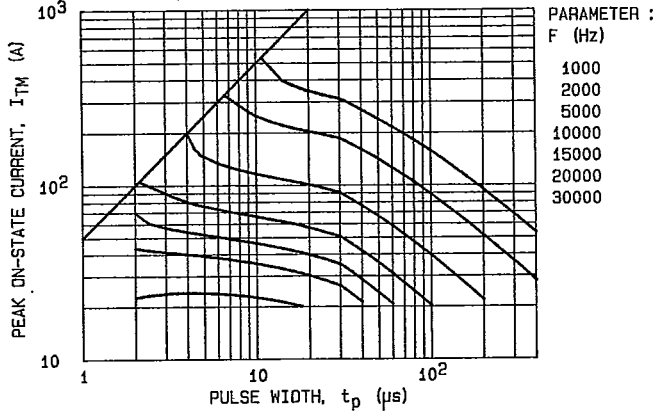

FIG.5 - MAXIMUM ALLOWABLE PEAK ON-STATE CURRENT VERSUS PULSE WIDTH FOR $T_C = 85^\circ\text{C}$.

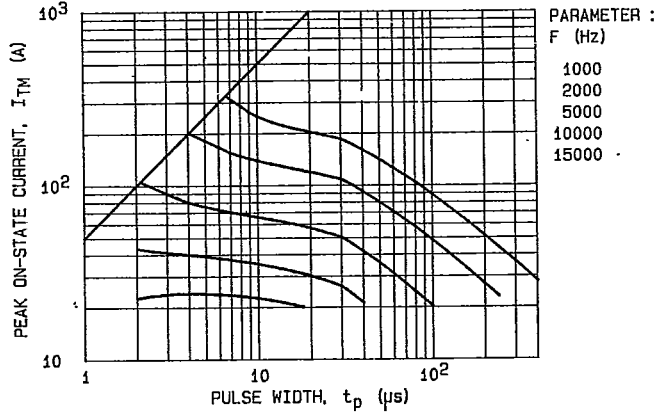
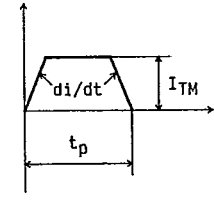

FIG.6 - MAXIMUM ALLOWABLE PEAK ON-STATE CURRENT VERSUS PULSE WIDTH FOR $T_C = 80^\circ\text{C}$.

$di/dt = 100 \text{ A}/\mu\text{s}$



- NOTES :
- $V_D \leq 600$ Volts.
 - $V_R \leq 1$ Volt.
 - R.C Snubber, $C = 22 \text{ nF}$,
 $R = 33 \Omega$.

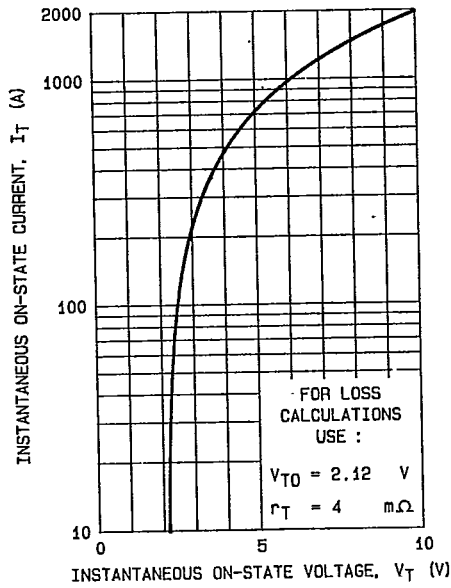

FIG.7 - MAXIMUM ON-STATE CONDUCTION CHARACTERISTIC ($T_J = 125^\circ\text{C}$).

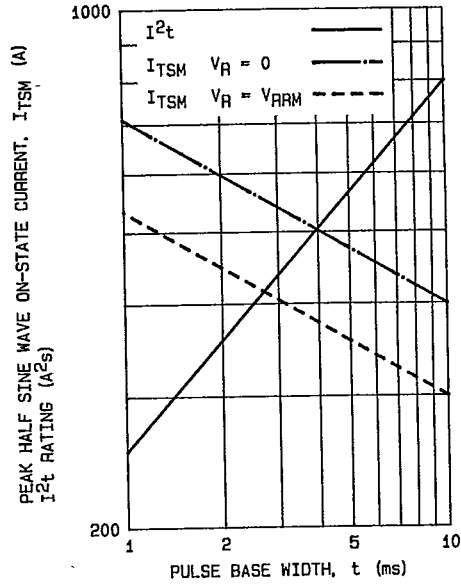

FIG.8 - NON REPETITIVE SUB-CYCLE SURGE ON-STATE CURRENT AND I^2t RATING (INITIAL $T_J = 125^\circ\text{C}$).

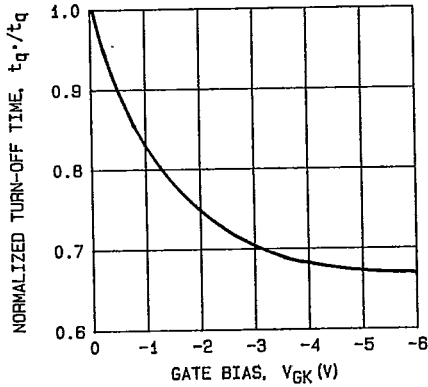

FIG.9 - TYPICAL VARIATION OF EFFECTIVE TURN-OFF TIME $t_{q'}$ WITH NEGATIVE GATE BIAS.

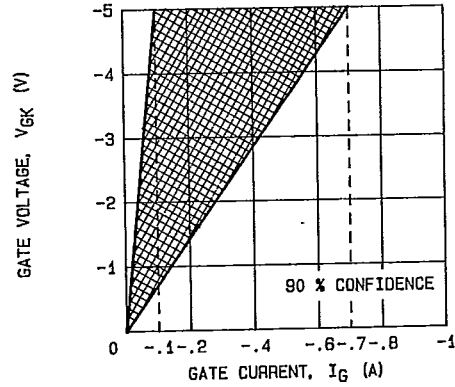

FIG.10 - REVERSE GATE CHARACTERISTICS.

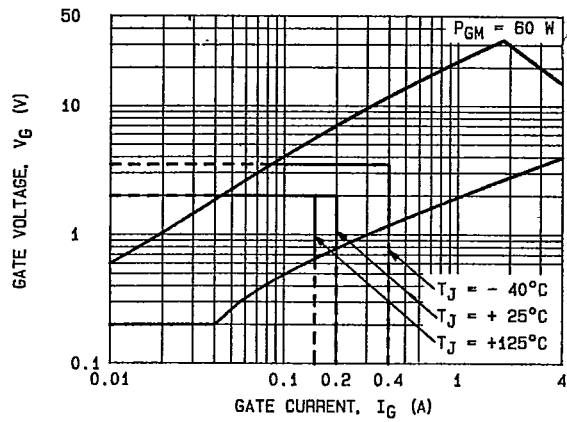

FIG.11 - GATE TRIGGER CHARACTERISTICS.

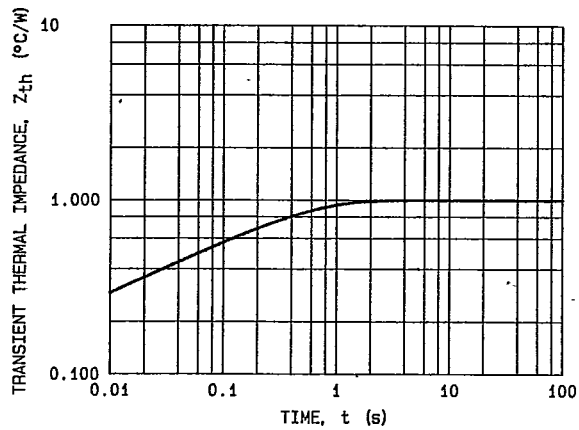
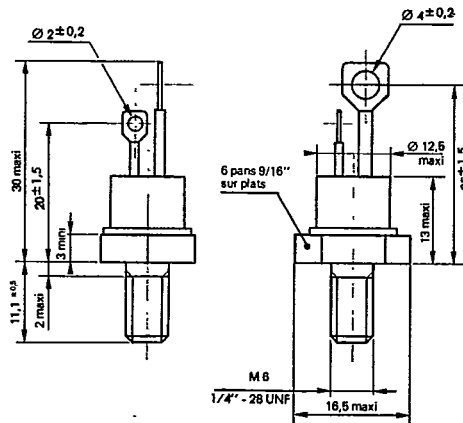

FIG.12 - TRANSIENT THERMAL IMPEDANCE JUNCTION TO CASE.



TO 48 CASE OUTLINE