

(TLP633)

OFFICE MACHINE.

HOUSEHOLD USE EQUIPMENT.

SOLID STATE RELAY.

SWITCHING POWER SUPPLY.

The TOSHIBA TLP633 and TLP634 consists of a photo-transistor optically coupled to a gallium arsenide infrared emitting diode in a six lead plastic DIP package.

TLP634 is no-base internal connection for high-EMI environments.

- Collector-emitter Voltage : 55V (Min.)
- Current Transfer Ratio : 50% (Min.)
Rank GB : 100% (Min.)
- UL Recognized : UL1577, File No. E67349
- BSI Approved : BS415 : 1990, BS7002 : 1989
(EN60950)
Certificate No. 7123, 7437
- SEMKO Approved : SS4330784,
Certificate No. 8937148 (TLP633)
9019123 (TLP634)
- Isolation Voltage : 4000V_{rms} (Min.)
- Option (D4) type
VDE Approved : DIN VDE0884 / 08. 87,
Certificate No. 68367

Maximum Operating Insulation Voltage : 630Vpk

Highest Permissible Over Voltage : 6000vpk

(Note) When a VDE0884 approved type is needed,
Please designate the "option (D4)"

- | | 7.62mm pich
standard type | 10.16mm pich
(LF2) type |
|------------------------|------------------------------|----------------------------|
| • Creepage Distance | : 7.0mm (Min) | 8.0mm (Min) |
| Clearance | : 7.0mm (Min) | 8.0mm (Min) |
| Internal Creepage Path | : 4.0mm (Min) | 4.0mm (Min) |
| Insulation Thickness | : 0.5mm (Min) | 0.5mm (Min) |

Unit in mm

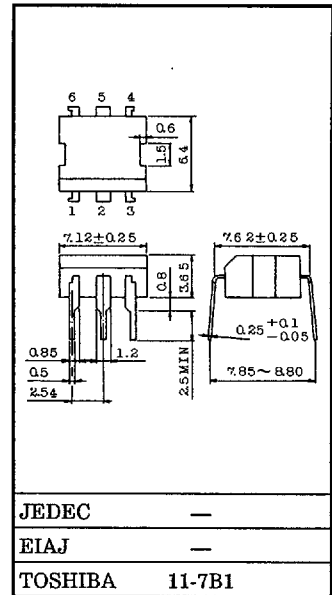

Weight : 0.37g

PIN CONFIGURATIONS (TOP VIEW)

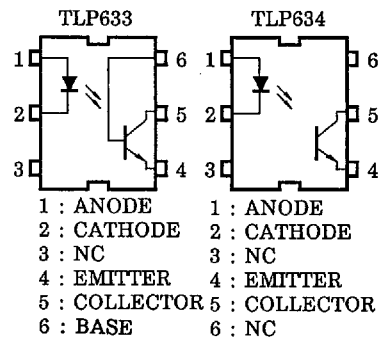

TLP633, 634

(TLP633)

Current Transfer Ratio

TYPE	CLASSIFICATION ※1	CURRENT TRANSFER RATIO (%) (I_C / I_F)		MARKING OF CLASSIFICATION
		$I_F = 5\text{mA}, V_{CE} = 5\text{V}, T_a = 25^\circ\text{C}$		
		MIN.	MAX.	
TLP633	(None)	50	600	BLANK, Y, Y [■] , G, G [■] , B, B [■] , GB
	Rank GR	50	150	Y, Y [■]
TLP634	Rank GR	100	300	G, G [■]
	Rank GB	200	600	B, B [■]
	Rank GB	100	600	G, G [■] , B, B [■] , GB

*1 : Ex. Rank GB : TLP633 (GB)

Note : Application type name for certification test, please use standard product type name, i. e.

TLP633 (GB) : TLP633

MAXIMUM RATINGS ($T_a = 25^\circ\text{C}$)

CHARACTERISTIC		SYMBOL	RATING	UNIT
LED	Forward Current	I_F	60	mA
	Forward Current Derating ($T_a \geq 39^\circ\text{C}$)	$\Delta I_F / ^\circ\text{C}$	-0.7	mA / $^\circ\text{C}$
	Peak Forward Current (100 μs pulse, 100pps)	I_{FP}	1	A
	Reverse Voltage	V_R	5	V
	Junction Temperature	T_j	125	$^\circ\text{C}$
DETECTOR	Collector-Emitter Voltage	V_{CEO}	55	V
	Collector-Base Voltage (TLP633)	V_{CBO}	80	V
	Emitter-Collector Voltage	V_{ECO}	7	V
	Emitter-Base Voltage (TLP633)	V_{EBO}	7	V
	Collector Current	I_C	50	mA
	Power Dissipation	P_C	150	mW
	Power Dissipation Derating ($T_a \geq 25^\circ\text{C}$)	$\Delta P_C / ^\circ\text{C}$	-1.5	mW / $^\circ\text{C}$
	Junction Temperature	T_j	125	$^\circ\text{C}$
	Storage Temperature Range	T_{stg}	-55~150	$^\circ\text{C}$
Operating Temperature Range	T_{opr}	-55~100	$^\circ\text{C}$	
Lead Soldering Temperature (10 s)	T_{sol}	260	$^\circ\text{C}$	
Total Package Power Dissipation	P_T	250	mW	
Total Package Power Dissipation Derating ($T_a \geq 25^\circ\text{C}$)	$\Delta P_T / ^\circ\text{C}$	-2.5	mW / $^\circ\text{C}$	
Isolation Voltage (AC, 1min., RH \leq 60%) (Note 1)	BV_S	4000	Vrms	

Note 1 : Device considered a two-terminal device : Pins 1, 2 and 3 shorted together and pins 4, 5 and 6 shorted together.

(TLP633)

INDIVIDUAL ELECTRICAL CHARACTERISTICS (Ta = 25°C)

CHARACTERISTIC		SYMBOL	TEST CONDITION	MIN.	TYP.	MAX.	UNIT
LED	Forward Voltage	V _F	I _F = 10mA	1.0	1.15	1.3	V
	Reverse Current	I _R	V _R = 5V	—	—	10	μA
	Capacitance	C _T	V = 0, f = 1MHz	—	30	—	pF
DETECTOR	Collector-Emitter Breakdown Voltage	V _{(BR)CEO}	I _C = 0.5mA	55	—	—	V
	Emitter-Collector Breakdown Voltage	V _{(BR)ECO}	I _E = 0.1mA	7	—	—	V
	Collector-Base Breakdown Voltage (TLP633)	V _{(BR)CBO}	I _C = 0.1mA	80	—	—	V
	Emitter-Base Breakdown Voltage (TLP633)	V _{(BR)EBO}	I _E = 0.1mA	7	—	—	V
	Collector Dark Current	I _{CEO}	V _{CE} = 24V	—	10	100	nA
			V _{CE} = 24V, Ta = 85°C	—	2	50	μA
	Collector Dark Current (TLP633)	I _{CER}	V _{CE} = 24V, Ta = 85°C R _{BE} = 1MΩ	—	0.5	10	μA
	Collector Dark Current (TLP633)	I _{CBO}	V _{CB} = 10V	—	0.1	—	nA
	DC Foward Current Gain (TLP633)	h _{FE}	V _{CE} = 5V, I _C = 0.5mA	—	400	—	—
	Capacitance Collector to Emitter	C _{CE}	V = 0, f = 1MHz	—	10	—	pF

COUPLED ELECTRICAL CHARACTERISTICS (Ta = 25°C)

CHARACTERISTIC	SYMBOL	TEST CONDITION	MIN.	TYP.	MAX.	UNIT
Current Transfer Ratio	I _C / I _F	I _F = 5mA, V _{CE} = 5V Rank GB	50	—	600	%
			100	—	600	
Saturated CTR	I _C / I _{F(sat)}	I _F = 1mA, V _{CE} = 0.4V Rank GB	—	60	—	%
			30	—	—	
Base Photo-Current	I _{PB}	I _F = 5mA, V _{CB} = 5V	—	10	—	μA
Collector-Emitter Saturation Voltage	V _{CE (sat)}	I _C = 2.4mA, I _F = 8mA I _C = 0.2mA, I _F = 1mA Rank GB	—	—	0.4	V
			—	0.2	—	
			—	—	0.4	

(TLP633)

ISOLATION CHARACTERISTICS (Ta = 25°C)

CHARACTERISTIC	SYMBOL	TEST CONDITION	MIN.	TYP.	MAX.	UNIT
Capacitance (Input to Output)	C _S	V _S =0, f=1MHz	—	0.8	—	pF
Isolation Resistance	R _S	V _S =500V	5×10 ¹⁰	10 ¹⁴	—	Ω
Isolation Voltage	BV _S	AC, 1minute	4000	—	—	V _{rms}
		AC, 1second, in oil	—	10000	—	
		DC, 1minute, in oil	—	10000	—	V _{dc}

SWITCHING CHARACTERISTICS (Ta = 25°C)

CHARACTERISTIC	SYMBOL	TEST CONDITION	MIN.	TYP.	MAX.	UNIT
Rise Time	t _r	V _{CC} =10V I _C =2mA R _L =100Ω	—	2	—	μs
Fall Time	t _f		—	3	—	
Turn-on Time	t _{ON}		—	3	10	
Turn-off Time	t _{OFF}		—	3	10	
Turn-on Time	t _{ON}	R _L =1.9kΩ (Fig.1) R _{BE} =OPEN V _{CC} =5V, I _F =16mA	—	3	—	μs
Storage Time	t _s		—	40	—	
Turn-off Time	t _{OFF}		—	90	—	
Turn-on Time	t _{ON}	R _L =1.9kΩ (Fig.1) R _{BE} =220kΩ (TLP633) V _{CC} =5V, I _F =16mA	—	3	—	μs
Storage Time	t _s		—	30	—	
Turn-off Time	t _{OFF}		—	60	—	

RECOMMENDED OPERATING CONDITIONS

CHARACTERISTIC	SYMBOL	MIN.	TYP.	MAX.	UNIT
Supply Voltage	V _{CC}	—	5	24	V
Forward Current	I _F	—	16	25	mA
Collector Current	I _C	—	1	10	mA
Operating Temperature	T _{opr}	-25	—	85	°C

Fig. 1 SWITCHING TIME TEST CIRCUIT

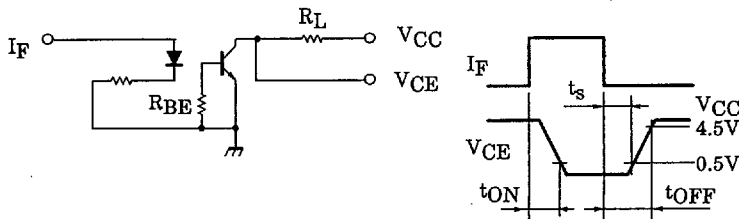

(TLP633)

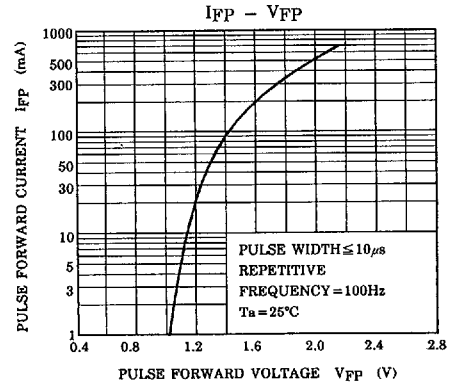
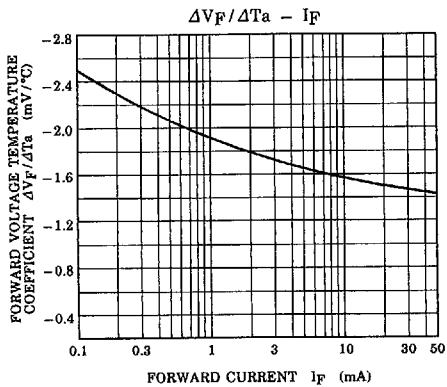
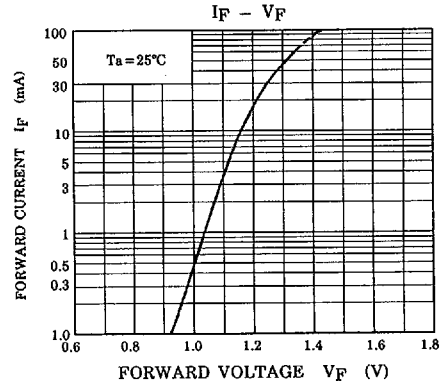
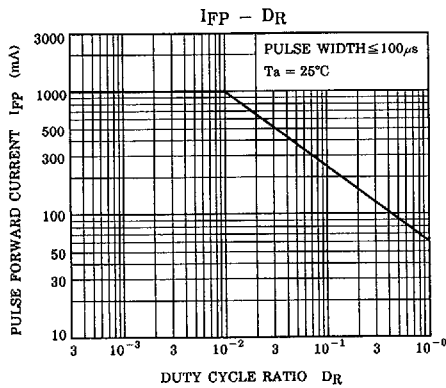
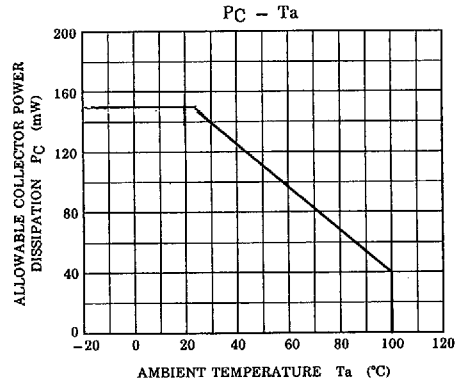
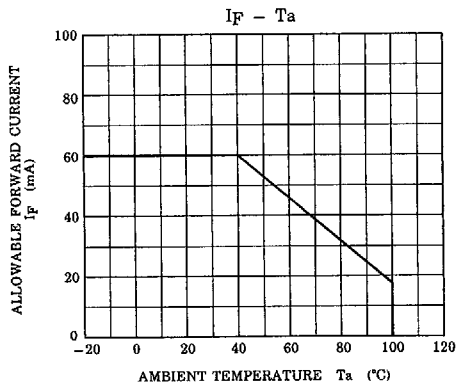

(TLP633)

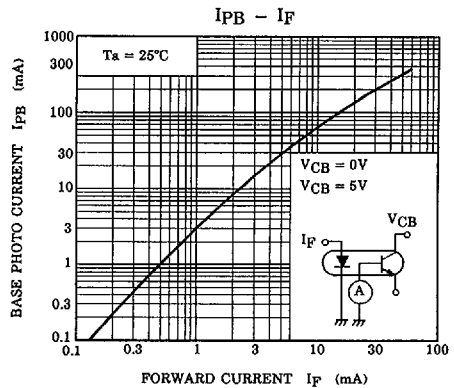
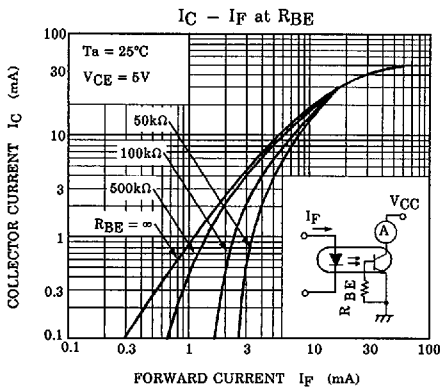
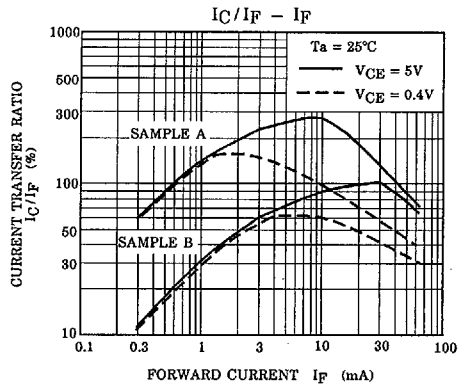
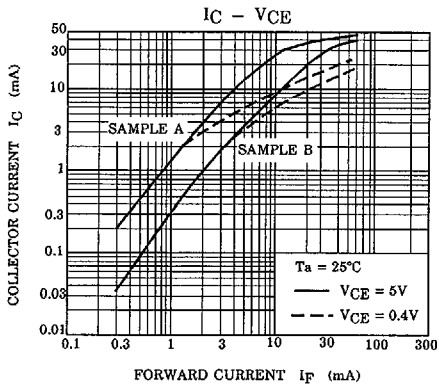
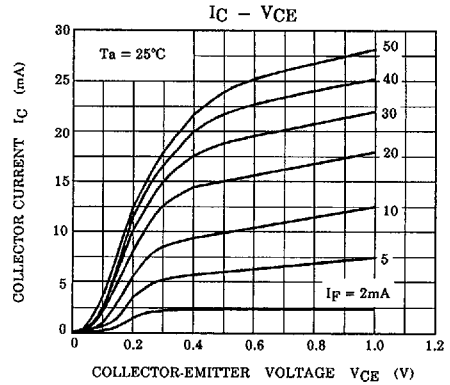
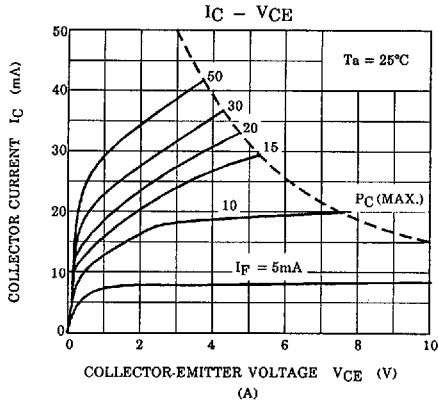

(TLP633)

