



# General Purpose Type Photocoupler

LTV-4N25 Series/LTV-4N26 Series

LTV-4N27 Series/LTV-4N28 Series

4N25 Series/4N26 Series/4N27 Series/4N28 Series

## Features

- Response Time  
(tr : TYP, 3  $\mu$  s at  $V_{CE}=10V$ ,  $I_C=2mA$ ,  $R_L=100 \Omega$ )
- UL approved (No. E113898)
- TUV approved (No. R9653630)
- CSA approved (No. CA91533-1)
- FIMKO approved (No. 193422)
- NEMKO approved (No. P96103013)
- DEMKO approved (No. 303985)
- SEMKO approved (No. 9646047/01-30)
- VDE approved (No. 094722 )
- Options available :
  - Leads with 0.4"(10.16mm)spacing (M Type)
  - Leads bends for surface mounting(S Type)
  - Tape and Reel of Type I for SMD(Add"-TA"Suffix)
  - Tape and Reel of Type II for SMD(Add"-TA1"Suffix)
  - VDE 0884 approvals (Add"-V"Suffix)

## Package Dimensions

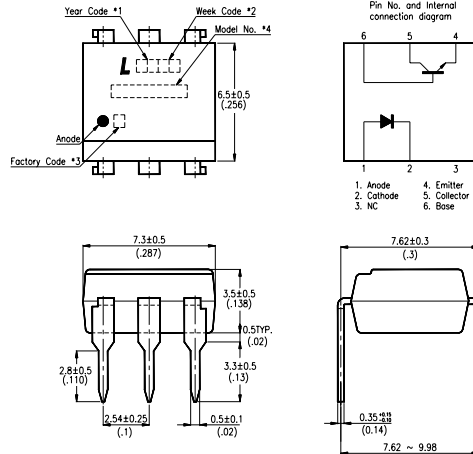

## Applications

1. I/O interfaces for computers.
2. System appliances, measuring instruments.
3. Signal transmission between circuits of different potentials and impedances.

## Note:

1. Year date code.
2. 2-digit work week.
3. Factory code shall be marked (Z : Taiwan, Y : Thailand).
4. Model No. : LTV4N25 ; LTV4N26 ; LTV4N27 ; LTV4N28 ; 4N25 ; 4N26 ; 4N27 ; 4N28.
5. All dimensions are in millimeters (inches).
6. Tolerance is  $\pm 0.25$ mm (.010") unless otherwise noted.
7. Specifications are subject to change without notice.

## Ordering Information

Part Number	Package	Safety Standard Approval	Application part number	
LTV-4N25 / 4N25 LTV-4N25M / 4N25M LTV-4N25S / 4N25S LTV-4N25S-TA / 4N25S-TA LTV-4N25S-TA1 / 4N25S-TA1	6-pin DIP 6-pin (leads with 0.4" spacing) 6-pin (lead bends for surface mount) 6-pin (tape and reel packaging of type I) 6-pin (tape and reel packaging of type II)	<ul style="list-style-type: none"> <li>• UL approved</li> <li>• TUV approved</li> <li>• CSA approved</li> <li>• FIMKO approved</li> <li>• NEMKO approved</li> <li>• SEMKO approved</li> <li>• DEMKO approved</li> </ul>	LTV - 4N25	
LTV-4N26 / 4N26 LTV-4N26M / 4N26M LTV-4N26S / 4N26S LTV-4N26S-TA / 4N26S-TA LTV-4N26S-TA1 / 4N26S-TA1	6-pin DIP 6-pin (leads with 0.4" spacing) 6-pin (lead bends for surface mount) 6-pin (tape and reel packaging of type I) 6-pin (tape and reel packaging of type II)		LTV - 4N26	
LTV-4N27 / 4N27 LTV-4N27M / 4N27M LTV-4N27S / 4N27S LTV-4N27S-TA / 4N27S-TA LTV-4N27S-TA1 / 4N27S-TA1	6-pin DIP 6-pin (leads with 0.4" spacing) 6-pin (lead bends for surface mount) 6-pin (tape and reel packaging of type I) 6-pin (tape and reel packaging of type II)		LTV - 4N27	
LTV-4N28 / 4N28 LTV-4N28M / 4N28M LTV-4N28S / 4N28S LTV-4N28S-TA / 4N28S-TA LTV-4N28S-TA1 / 4N28S-TA1	6-pin DIP 6-pin (leads with 0.4" spacing) 6-pin (lead bends for surface mount) 6-pin (tape and reel packaging of type I) 6-pin (tape and reel packaging of type II)		LTV - 4N28	
LTV4N25-V / 4N25-V LTV4N25M-V / 4N25M-V LTV4N25S-V / 4N25S-V LTV4N25STA-V / 4N25STA-V LTV4N25STA1-V / 4N25STA1-V	6-pin DIP 6-pin (leads with 0.4" spacing) 6-pin (lead bends for surface mount) 6-pin (tape and reel packaging of type I) 6-pin (tape and reel packaging of type II)		<ul style="list-style-type: none"> <li>• VDE approved</li> </ul>	LTV - 4N25
LTV4N26-V / 4N26-V LTV4N26M-V / 4N26M-V LTV4N26S-V / 4N26S-V LTV4N26STA-V / 4N26STA-V LTV4N26STA1-V / 4N26STA1-V	6-pin DIP 6-pin (leads with 0.4" spacing) 6-pin (lead bends for surface mount) 6-pin (tape and reel packaging of type I) 6-pin (tape and reel packaging of type II)			LTV - 4N26
LTV4N27-V / 4N27-V LTV4N27M-V / 4N27M-V LTV4N27S-V / 4N27S-V LTV4N27STA-V / 4N27STA-V LTV4N27STA1-V / 4N27STA1-V	6-pin DIP 6-pin (leads with 0.4" spacing) 6-pin (lead bends for surface mount) 6-pin (tape and reel packaging of type I) 6-pin (tape and reel packaging of type II)			LTV - 4N27
LTV4N28-V / 4N28-V LTV4N28M-V / 4N28M-V LTV4N28S-V / 4N28S-V LTV4N28STA-V / 4N28STA-V LTV4N28STA1-V / 4N28STA1-V	6-pin DIP 6-pin (leads with 0.4" spacing) 6-pin (lead bends for surface mount) 6-pin (tape and reel packaging of type I) 6-pin (tape and reel packaging of type II)			LTV - 4N28

## Absolute Maximum Ratings

(Ta=25°C)

Parameter		Symbol	Rating	Unit
Input	Forward Current	IF	80	mA
	Reverse Voltage	VR	6	V
	Power Dissipation	P	150	mW
Output	Collector-Emitter Voltage	VCEO	30	V
	Collector-Base Voltage	VCBO	70	V
	Emitter-Collector Voltage	VECO	7	V
	Collector Current	IC	100	mA
	Collector Power Dissipation	PC	150	mW
Total Power Dissipation		Ptot	250	mW
*1. Isolation Voltage	4N25	Viso	2,500	Vrms
	4N26		1,500	
	4N27		1,500	
	4N28		500	
Operating Temperature		Topr	-55~+100	°C
Storage Temperature		Tstg	-55~+150	°C
*2. Soldering Temperature		Tsol	260	°C

\*1. AC for 1 minute, R.H. = 40 ~ 60%

• Isolation voltage shall be measured using the following method.

(1) Short between anode and cathode on the primary side and between collector, emitter and base on the secondary side.

(2) The isolation voltage tester with zero-cross circuit shall be used.

(3) The waveform of applied voltage shall be a sine wave.

\*2. For 10 seconds.

## Electrical/Optical Characteristics

(Ta=25°C)

Parameter		Symbol	Min.	Typ.	Max.	Unit	Conditions
Input	Forward Voltage	VF	—	1.2	1.5	V	IF=10mA
	Reverse Current	IR	—	—	10	μA	VR=4V
	Terminal Capacitance	Ct	—	50	—	pF	V=0, f=1kHz
Output	Collector Dark Current	ICEO	—	—	50	nA	VCE=10V
	4N25/26/27		—	—	100		
	4N28	—	—	—	—		
	Collector-Emitter Breakdown Voltage	BVCEO	30	—	—	V	IC=0.1mA
Emitter-Collector Breakdown Voltage	BVECO	7	—	—	V	IE=10 μA	
Collector-Base Breakdown Voltage	BVCBO	70	—	—	V	IC=0.1mA	
Transfer Characteristics	Collector Current	IC	2	—	—	mA	IF=10mA
	4N25/26		1	—	—		VCE=10V
	4N27/28	—	—	—	—		
	*1 Current Transfer Ratio	CTR	20	—	—	%	IF=10mA
	4N25/26		10	—	—		VCE=10V
	4N27/28	—	—	—	—		
	Collector-emitter Saturation Voltage	VCE(sat)	—	0.1	0.5	V	IF=50mA, IC=2mA
Isolation Resistance	Riso	5 × 10 <sup>10</sup>	1 × 10 <sup>11</sup>	—	Ω	DC500V, 40~60% R.H.	
Floating Capacitance	Cf	—	1.0	—	pF	V=0, f=1MHz	
Response Time (Rise)	tr	—	3	—	μs	VCE=10V, RBE= ∞	
Response Time (Fall)	tf	—	3	—	μs	RL=100 Ω, IC=2mA	

\*1. CTR =  $\frac{I_C}{I_F} \times 100\%$

# Typical Electrical/Optical Characteristic Curves (25°C Ambient Temperature Unless Otherwise Noted)

Fig.1 Forward Current vs. Ambient Temperature

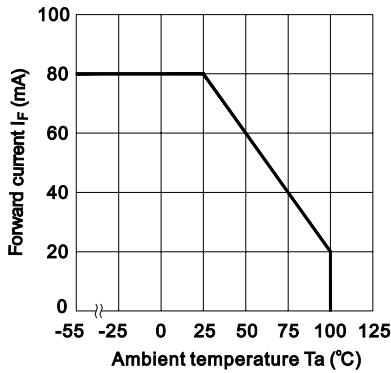

Fig.2 Collector Power Dissipation vs. Ambient Temperature

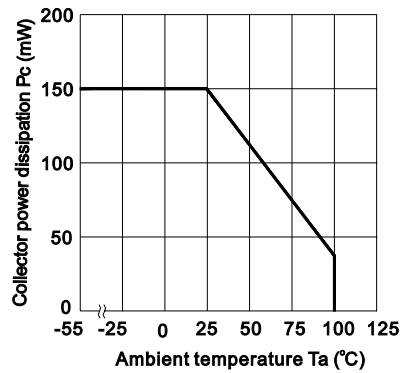

Fig.3 Forward Current vs. Forward Voltage

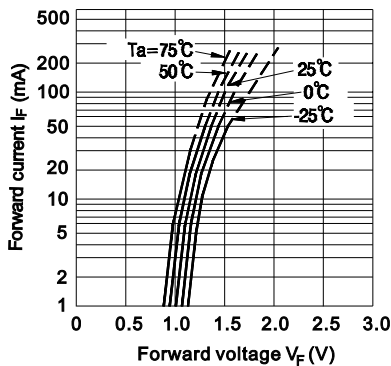

Fig.4 Current Transfer Ratio vs. Forward Current

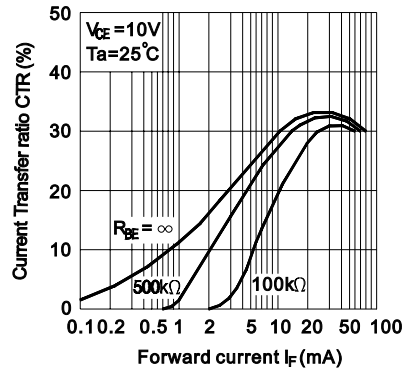

Fig.5 Collector Current vs. Collector-emitter Voltage

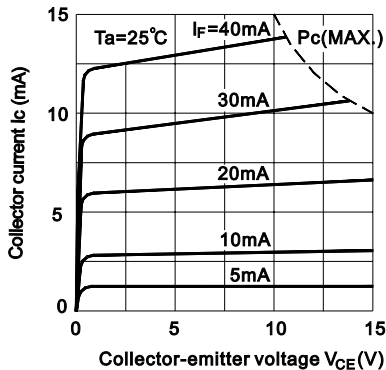
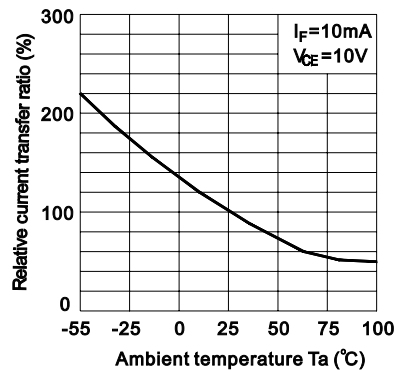
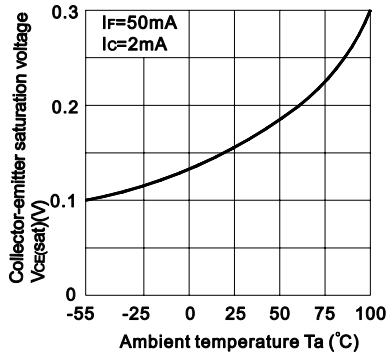

Fig.6 Relative Current Transfer Ratio vs. Ambient Temperature



PHOTOCOUPLER

**Fig.7 Collector-emitter Saturation Voltage vs. Ambient Temperature**



**Fig.8 Collector Dark Current vs. Ambient Temperature**

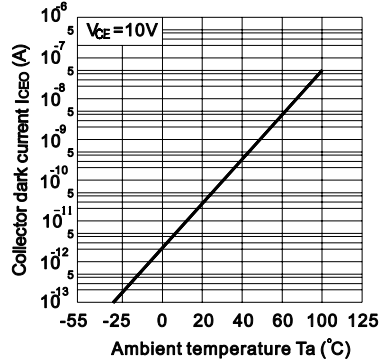

**Fig.9 Response Time vs. Load Resistance**

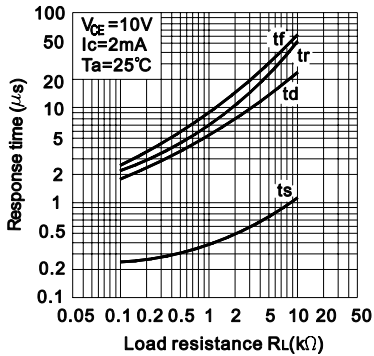

**Fig.10 Frequency Response**

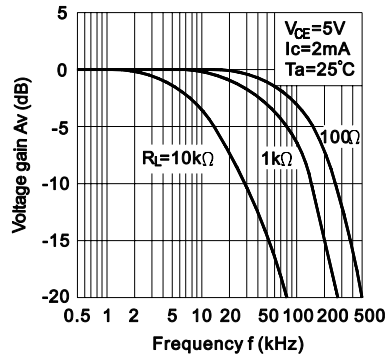

**Fig.11 Collector-emitter Saturation Voltage vs. Forward Current**

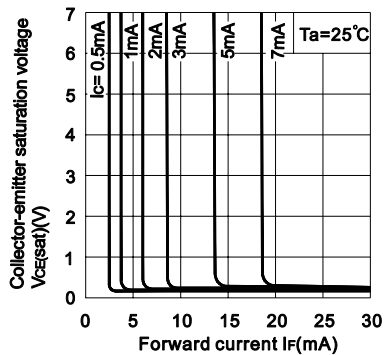

**Test Circuit for Response Time**

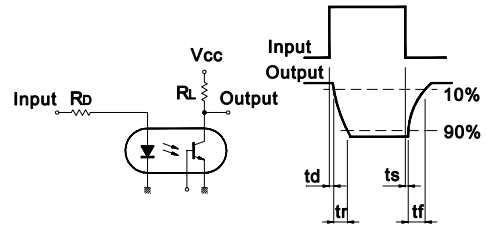

**Test Circuit for Frequency Response**

