

BZX84B4V7LT1, BZX84C2V4LT1 Series

Zener Voltage Regulators

225 mW SOT-23 Surface Mount

This series of Zener diodes is offered in the convenient, surface mount plastic SOT-23 package. These devices are designed to provide voltage regulation with minimum space requirement. They are well suited for applications such as cellular phones, hand held portables, and high density PC boards.

Specification Features

- Pb-Free Packages are Available
- 225 mW Rating on FR-4 or FR-5 Board
- Zener Breakdown Voltage Range – 2.4 V to 75 V
- Package Designed for Optimal Automated Board Assembly
- Small Package Size for High Density Applications
- ESD Rating of Class 3 (>16 KV) per Human Body Model
- Tight Tolerance Series Available (See Page 4)

Mechanical Characteristics

CASE: Void-free, transfer-molded, thermosetting plastic case

FINISH: Corrosion resistant finish, easily Solderable

MAXIMUM CASE TEMPERATURE FOR SOLDERING PURPOSES:
260°C for 10 Seconds

POLARITY: Cathode indicated by polarity band

FLAMMABILITY RATING: UL 94 V-0

MAXIMUM RATINGS

Rating	Symbol	Max	Unit
Total Power Dissipation on FR-5 Board, (Note 1) @ $T_A = 25^\circ\text{C}$ Derated above 25°C	P_D	225	mW
Thermal Resistance, Junction-to-Ambient	$R_{\theta JA}$	1.8	$\text{mW}/^\circ\text{C}$
Total Power Dissipation on Alumina Substrate, (Note 2) @ $T_A = 25^\circ\text{C}$ Derated above 25°C	P_D	300	mW
Thermal Resistance, Junction-to-Ambient	$R_{\theta JA}$	2.4	$\text{mW}/^\circ\text{C}$
Junction and Storage Temperature Range	T_J, T_{stg}	-65 to +150	$^\circ\text{C}$

Maximum ratings are those values beyond which device damage can occur. Maximum ratings applied to the device are individual stress limit values (not normal operating conditions) and are not valid simultaneously. If these limits are exceeded, device functional operation is not implied, damage may occur and reliability may be affected.

1. FR-5 = 1.0 X 0.75 X 0.62 in.
2. Alumina = 0.4 X 0.3 X 0.024 in., 99.5% alumina.



ON Semiconductor®

<http://onsemi.com>

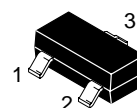
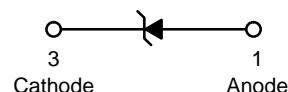

**SOT-23
CASE 318
STYLE 8**

MARKING DIAGRAM

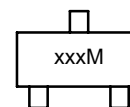

xxx = Specific Device Code
M = Date Code

ORDERING INFORMATION

Device*	Package	Shipping†
BZX84CxxxLT1	SOT-23	3000/Tape & Reel
BZX84CxxxLT1G	SOT-23 (Pb-Free)	3000/Tape & Reel
BZX84CxxxLT3	SOT-23	10,000/Tape & Reel
BZX84BxxxLT1	SOT-23	3000/Tape & Reel
BZX84BxxxLT1G	SOT-23 (Pb-Free)	3000/Tape & Reel
BZX84BxxxLT3	SOT-23	10,000/Tape & Reel

*The "T1" suffix refers to an 8 mm, 7 inch reel.
The "T3" suffix refers to an 8 mm, 13 inch reel.

†For information on tape and reel specifications, including part orientation and tape sizes, please refer to our Tape and Reel Packaging Specification Brochure, BRD8011/D.

DEVICE MARKING INFORMATION

See specific marking information in the device marking column of the Electrical Characteristics table on page 3 of this data sheet.

BZX84B4V7LT1, BZX84C2V4LT1 Series

ELECTRICAL CHARACTERISTICS

(Pinout: 1-Anode, 2-No Connection, 3-Cathode) ($T_A = 25^\circ\text{C}$ unless otherwise noted, $V_F = 0.95\text{ V Max. @ } I_F = 10\text{ mA}$)

Symbol	Parameter
V_Z	Reverse Zener Voltage @ I_{ZT}
I_{ZT}	Reverse Current
Z_{ZT}	Maximum Zener Impedance @ I_{ZT}
I_R	Reverse Leakage Current @ V_R
V_R	Reverse Voltage
I_F	Forward Current
V_F	Forward Voltage @ I_F
Θ_{VZ}	Maximum Temperature Coefficient of V_Z
C	Max. Capacitance @ $V_R = 0$ and $f = 1\text{ MHz}$

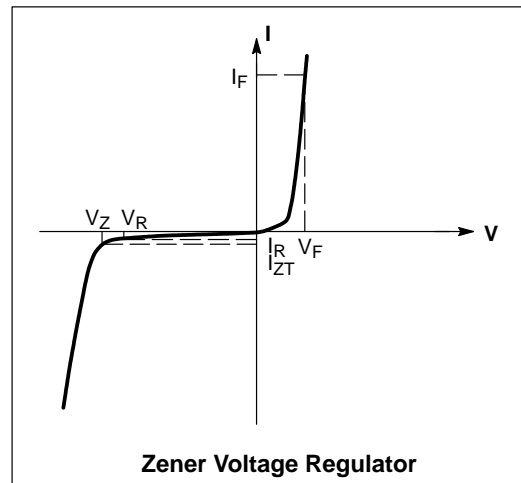

BZX84B4V7LT1, BZX84C2V4LT1 Series

ELECTRICAL CHARACTERISTICS – BZX84CxxxLT1 SERIES (STANDARD TOLERANCE)

(Pinout: 1-Anode, 2-No Connection, 3-Cathode) (T_A = 25°C unless otherwise noted, V_F = 0.90 V Max. @ I_F = 10 mA)
 (Devices listed in **bold, italic** are ON Semiconductor Preferred devices.)

Device	Device Marking	V _{Z1} (Volts) @ I _{Z1} = 5 mA (Note 3)			Z _{ZT1} (Ω) @ I _{Z1} = 5 mA	V _{Z2} (V) @ I _{Z2} = 1 mA (Note 3)		Z _{ZT2} (Ω) @ I _{Z2} = 1 mA	V _{Z3} (V) @ I _{Z3} = 20 mA (Note 3)		Z _{ZT3} (Ω) @ I _{Z3} = 20 mA	Max Reverse Leakage Current		θ _{VZ} (mV/k) @ I _{Z1} = 5 mA		C (pF) @ V _R = 0 f = 1 MHz
		Min	Nom	Max		Min	Max		Min	Max		I _R (μA)	V _R (Volts)	Min	Max	
BZX84C2V4LT1, G*	Z11	2.2	2.4	2.6	100	1.7	2.1	600	2.6	3.2	50	50	1	-3.5	0	450
BZX84C2V7LT1, G*	Z12	2.5	2.7	2.9	100	1.9	2.4	600	3	3.6	50	20	1	-3.5	0	450
BZX84C3V0LT1	Z13	2.8	3	3.2	95	2.1	2.7	600	3.3	3.9	50	10	1	-3.5	0	450
BZX84C3V3LT1, G*	Z14	3.1	3.3	3.5	95	2.3	2.9	600	3.6	4.2	40	5	1	-3.5	0	450
BZX84C3V6LT1, G*	Z15	3.4	3.6	3.8	90	2.7	3.3	600	3.9	4.5	40	5	1	-3.5	0	450
BZX84C3V9LT1, G*	Z16	3.7	3.9	4.1	90	2.9	3.5	600	4.1	4.7	30	3	1	-3.5	-2.5	450
BZX84C4V3LT1, G*	W9	4	4.3	4.6	90	3.3	4	600	4.4	5.1	30	3	1	-3.5	0	450
BZX84C4V7LT1	Z1	4.4	4.7	5	80	3.7	4.7	500	4.5	5.4	15	3	2	-3.5	0.2	260
BZX84C5V1LT1	Z2	4.8	5.1	5.4	60	4.2	5.3	480	5	5.9	15	2	2	-2.7	1.2	225
BZX84C5V6LT1	Z3	5.2	5.6	6	40	4.8	6	400	5.2	6.3	10	1	2	-2.0	2.5	200
BZX84C6V2LT1	Z4	5.8	6.2	6.6	10	5.6	6.6	150	5.8	6.8	6	3	4	0.4	3.7	185
BZX84C6V8LT1	Z5	6.4	6.8	7.2	15	6.3	7.2	80	6.4	7.4	6	2	4	1.2	4.5	155
BZX84C7V5LT1	Z6	7	7.5	7.9	15	6.9	7.9	80	7	8	6	1	5	2.5	5.3	140
BZX84C8V2LT1	Z7	7.7	8.2	8.7	15	7.6	8.7	80	7.7	8.8	6	0.7	5	3.2	6.2	135
BZX84C9V1LT1	Z8	8.5	9.1	9.6	15	8.4	9.6	100	8.5	9.7	8	0.5	6	3.8	7.0	130
BZX84C10LT1, G*	Z9	9.4	10	10.6	20	9.3	10.6	150	9.4	10.7	10	0.2	7	4.5	8.0	130
BZX84C11LT1, G*	Y1	10.4	11	11.6	20	10.2	11.6	150	10.4	11.8	10	0.1	8	5.4	9.0	130
BZX84C12LT1	Y2	11.4	12	12.7	25	11.2	12.7	150	11.4	12.9	10	0.1	8	6.0	10.0	130
BZX84C13LT1, G*	Y3	12.4	13	14.1	30	12.3	14	170	12.5	14.2	15	0.1	8	7.0	11.0	120
BZX84C15LT1	Y4	14.3	15	15.8	30	13.7	15.5	200	13.9	15.7	20	0.05	10.5	9.2	13.0	110
BZX84C16LT1, G*	Y5	15.3	16	17.1	40	15.2	17	200	15.4	17.2	20	0.05	11.2	10.4	14.0	105
BZX84C18LT1	Y6	16.8	18	19.1	45	16.7	19	225	16.9	19.2	20	0.05	12.6	12.4	16.0	100
BZX84C20LT1	Y7	18.8	20	21.2	55	18.7	21.1	225	18.9	21.4	20	0.05	14	14.4	18.0	85
BZX84C22LT1	Y8	20.8	22	23.3	55	20.7	23.2	250	20.9	23.4	25	0.05	15.4	16.4	20.0	85
BZX84C24LT1	Y9	22.8	24	25.6	70	22.7	25.5	250	22.9	25.7	25	0.05	16.8	18.4	22.0	80
Device	Device Marking	V _{Z1} Below @ I _{Z1} = 2 mA			Z _{ZT1} Below @ I _{Z1} = 2 mA	V _{Z2} Below @ I _{Z2} = 0.1 mA		Z _{ZT2} Below @ I _{Z2} = 0.5 mA	V _{Z3} Below @ I _{Z3} = 10 mA		Z _{ZT3} Below @ I _{Z3} = 10 mA	Max Reverse Leakage Current		θ _{VZ} (mV/k) Below @ I _{Z1} = 2 mA		C (pF) @ V _R = 0 f = 1 MHz
		Min	Nom	Max		Min	Max		Min	Max		I _R (μA)	V _R (V)	Min	Max	
BZX84C27LT1, G*	Y10	25.1	27	28.9	80	25	28.9	300	25.2	29.3	45	0.05	18.9	21.4	25.3	70
BZX84C30LT1	Y11	28	30	32	80	27.8	32	300	28.1	32.4	50	0.05	21	24.4	29.4	70
BZX84C33LT1	Y12	31	33	35	80	30.8	35	325	31.1	35.4	55	0.05	23.1	27.4	33.4	70
BZX84C36LT1	Y13	34	36	38	90	33.8	38	350	34.1	38.4	60	0.05	25.2	30.4	37.4	70
BZX84C39LT1, G*	Y14	37	39	41	130	36.7	41	350	37.1	41.5	70	0.05	27.3	33.4	41.2	45
BZX84C43LT1, G*	Y15	40	43	46	150	39.7	46	375	40.1	46.5	80	0.05	30.1	37.6	46.6	40
BZX84C47LT1	Y16	44	47	50	170	43.7	50	375	44.1	50.5	90	0.05	32.9	42.0	51.8	40
BZX84C51LT1	Y17	48	51	54	180	47.6	54	400	48.1	54.6	100	0.05	35.7	46.6	57.2	40
BZX84C56LT1	Y18	52	56	60	200	51.5	60	425	52.1	60.8	110	0.05	39.2	52.2	63.8	40
BZX84C62LT1	Y19	58	62	66	215	57.4	66	450	58.2	67	120	0.05	43.4	58.8	71.6	35
BZX84C68LT1	Y20	64	68	72	240	63.4	72	475	64.2	73.2	130	0.05	47.6	65.6	79.8	35
BZX84C75LT1, G*	Y21	70	75	79	255	69.4	79	500	70.3	80.2	140	0.05	52.5	73.4	88.6	35

3. Zener voltage is measured with a pulse test current I_Z at an ambient temperature of 25°C.

* The "G" suffix indicates Pb-Free package available.

BZX84B4V7LT1, BZX84C2V4LT1 Series

ELECTRICAL CHARACTERISTICS – BZX84BxxxL (Tight Tolerance Series)

(Pinout: 1-Anode, 2-No Connection, 3-Cathode) ($T_A = 25^\circ\text{C}$ unless otherwise noted, $V_F = 0.90\text{ V Max.}$ @ $I_F = 10\text{ mA}$)

Device	Device Marking	V_Z (Volts) @ $I_{ZT} = 5\text{ mA}$ (Note 4)			$Z_{ZT} (\Omega)$ @ $I_{ZT} = 5\text{ mA}$ (Note 4)	Max Reverse Leakage Current		θ_{VZ} (mV/k) @ $I_{ZT} = 5\text{ mA}$		C (pF) @ $V_R = 0$, f = 1 MHz
						I_R	V_R			
		Min	Nom	Max	Max	μA	@ Volts	Min	Max	
BZX84B4V7LT1	T10	4.61	4.7	4.79	80	3	2	-3.5	0.2	260
BZX84B5V1LT1	T11	5.00	5.1	5.20	60	2	2	-2.7	1.2	225
BZX84B5V6LT1	T12	5.49	5.6	5.71	40	1	2	-2	2.5	200
BZX84B6V2LT1, G*	T13	6.08	6.2	6.32	10	3	4	0.4	3.7	185
BZX84B6V8LT1, G*	T14	6.66	6.8	6.94	15	2	4	1.2	4.5	155
BZX84B7V5LT1	T15	7.35	7.5	7.65	15	1	5	2.5	5.3	140
BZX84B8V2LT1, G*	T16	8.04	8.2	8.36	15	0.7	5	3.2	6.2	135
BZX84B9V1LT1, G*	T17	8.92	9.1	9.28	15	0.5	6	3.8	7	130
BZX84B16LT1	T19	15.7	16	16.3	40	0.05	11.2	10.4	14	105
BZX84B18LT1	T20	17.6	18	18.4	45	0.05	12.6	12.4	16	100

4. Zener voltage is measured with a pulse test current I_Z at an ambient temperature of 25°C .

* The "G" suffix indicates Pb-Free package available.

BZX84B4V7LT1, BZX84C2V4LT1 Series

TYPICAL CHARACTERISTICS

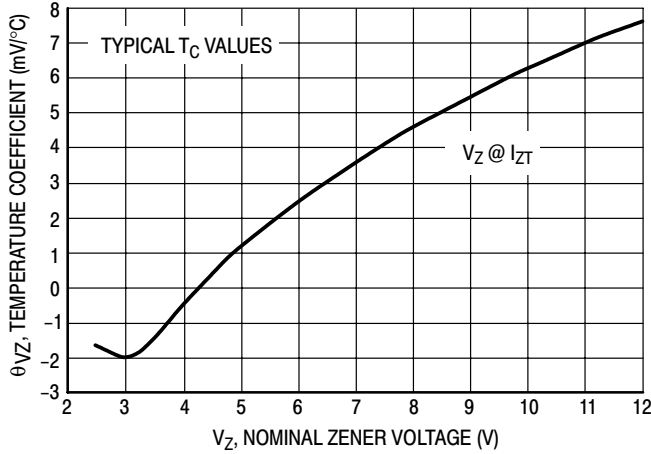

**Figure 1. Temperature Coefficients
(Temperature Range -55°C to +150°C)**

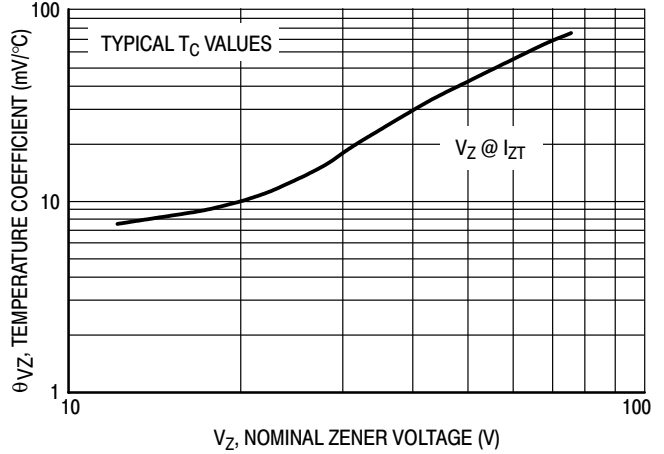

**Figure 2. Temperature Coefficients
(Temperature Range -55°C to +150°C)**

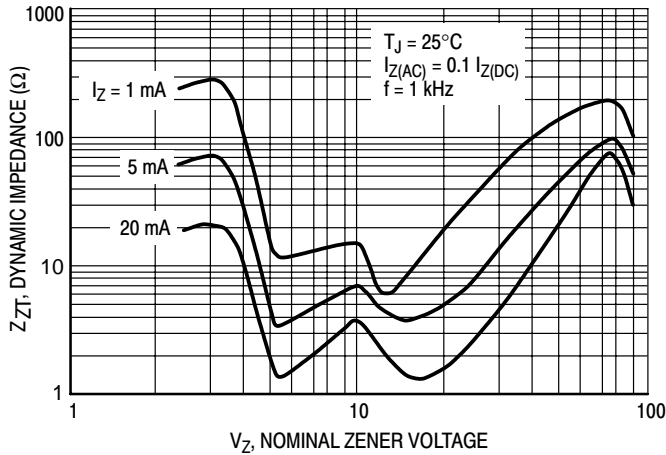

**Figure 3. Effect of Zener Voltage on
Zener Impedance**

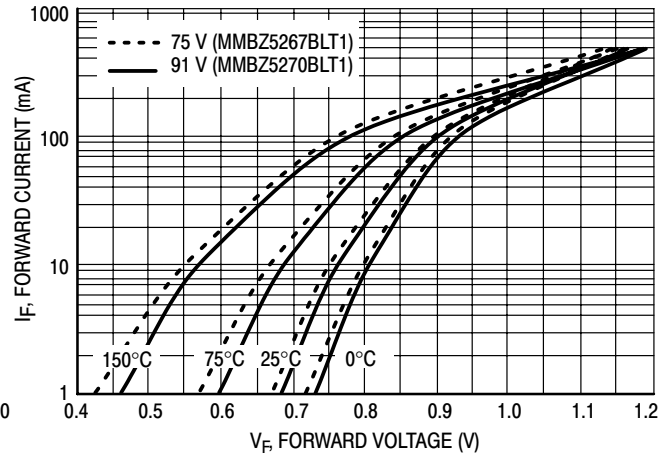

Figure 4. Typical Forward Voltage

BZX84B4V7LT1, BZX84C2V4LT1 Series

TYPICAL CHARACTERISTICS

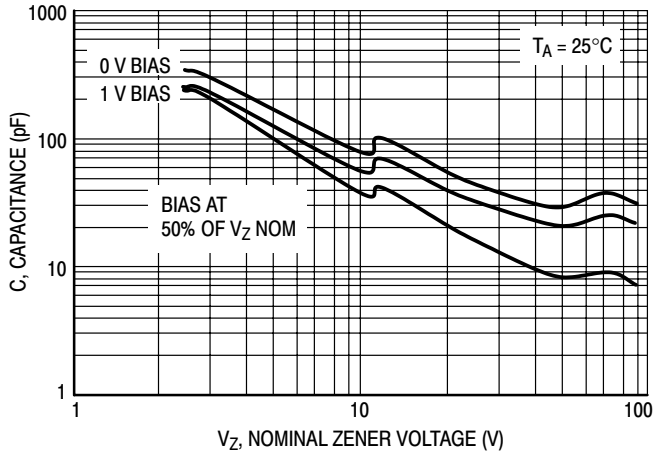

Figure 5. Typical Capacitance

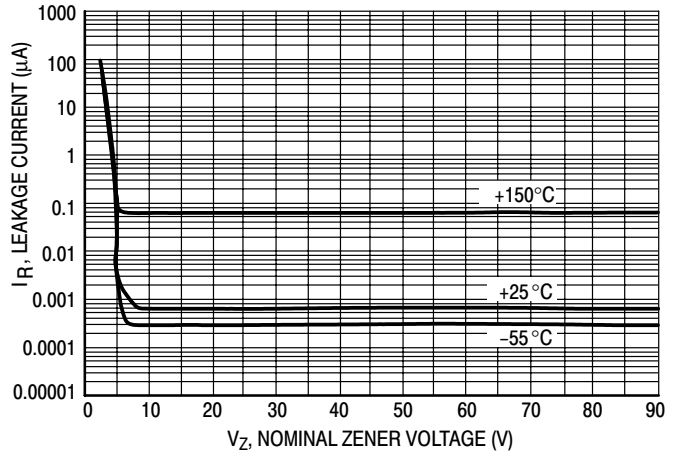

Figure 6. Typical Leakage Current

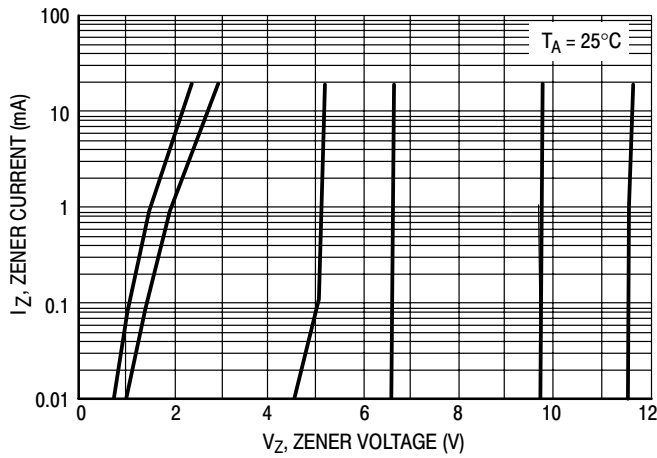

Figure 7. Zener Voltage versus Zener Current
(V_Z Up to 12 V)

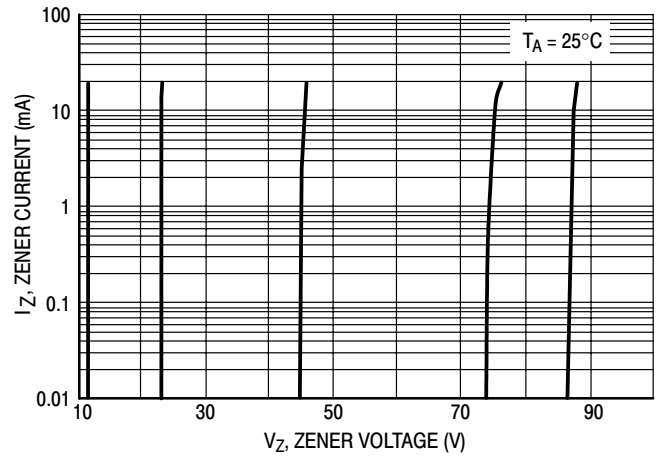
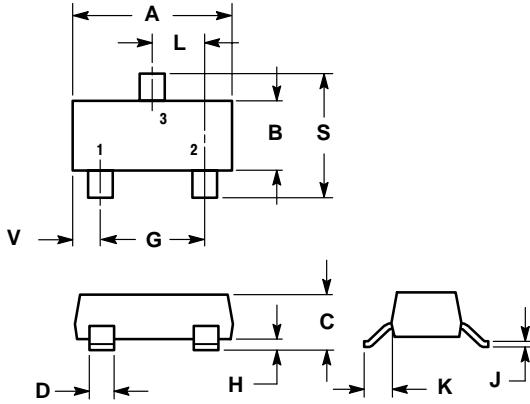

Figure 8. Zener Voltage versus Zener Current
(12 V to 91 V)

BZX84B4V7LT1, BZX84C2V4LT1 Series

PACKAGE DIMENSIONS

SOT-23
TO-236AB
CASE 318-09
ISSUE AH



NOTES:

1. DIMENSIONING AND TOLERANCING PER ANSI Y14.5M, 1982.
2. CONTROLLING DIMENSION: INCH.
3. MAXIMUM LEAD THICKNESS INCLUDES LEAD FINISH THICKNESS. MINIMUM LEAD THICKNESS IS THE MINIMUM THICKNESS OF BASE MATERIAL.
4. 318-01, -02, AND -06 OBSOLETE, NEW STANDARD 318-09.

DIM	INCHES		MILLIMETERS	
	MIN	MAX	MIN	MAX
A	0.1102	0.1197	2.80	3.04
B	0.0472	0.0551	1.20	1.40
C	0.0385	0.0498	0.99	1.26
D	0.0140	0.0200	0.36	0.50
G	0.0670	0.0826	1.70	2.10
H	0.0040	0.0098	0.10	0.25
J	0.0034	0.0070	0.085	0.177
K	0.0180	0.0236	0.45	0.60
L	0.0350	0.0401	0.89	1.02
S	0.0830	0.0984	2.10	2.50
V	0.0177	0.0236	0.45	0.60

STYLE 8:

1. ANODE
2. NO CONNECTION
3. CATHODE

SOLDERING FOOTPRINT*

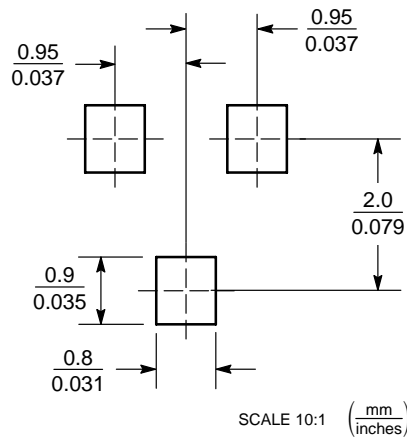

*For additional information on our Pb-Free strategy and soldering details, please download the ON Semiconductor Soldering and Mounting Techniques Reference Manual, SOLDERRM/D.

BZX84B4V7LT1, BZX84C2V4LT1 Series

ON Semiconductor and  are registered trademarks of Semiconductor Components Industries, LLC (SCILLC). SCILLC reserves the right to make changes without further notice to any products herein. SCILLC makes no warranty, representation or guarantee regarding the suitability of its products for any particular purpose, nor does SCILLC assume any liability arising out of the application or use of any product or circuit, and specifically disclaims any and all liability, including without limitation special, consequential or incidental damages. "Typical" parameters which may be provided in SCILLC data sheets and/or specifications can and do vary in different applications and actual performance may vary over time. All operating parameters, including "Typicals" must be validated for each customer application by customer's technical experts. SCILLC does not convey any license under its patent rights nor the rights of others. SCILLC products are not designed, intended, or authorized for use as components in systems intended for surgical implant into the body, or other applications intended to support or sustain life, or for any other application in which the failure of the SCILLC product could create a situation where personal injury or death may occur. Should Buyer purchase or use SCILLC products for any such unintended or unauthorized application, Buyer shall indemnify and hold SCILLC and its officers, employees, subsidiaries, affiliates, and distributors harmless against all claims, costs, damages, and expenses, and reasonable attorney fees arising out of, directly or indirectly, any claim of personal injury or death associated with such unintended or unauthorized use, even if such claim alleges that SCILLC was negligent regarding the design or manufacture of the part. SCILLC is an Equal Opportunity/Affirmative Action Employer. This literature is subject to all applicable copyright laws and is not for resale in any manner.

PUBLICATION ORDERING INFORMATION

LITERATURE FULFILLMENT:

Literature Distribution Center for ON Semiconductor
P.O. Box 5163, Denver, Colorado 80217 USA

Phone: 303-675-2175 or 800-344-3860 Toll Free USA/Canada

Fax: 303-675-2176 or 800-344-3867 Toll Free USA/Canada

Email: orderlit@onsemi.com

N. American Technical Support: 800-282-9855 Toll Free
USA/Canada

Japan: ON Semiconductor, Japan Customer Focus Center

2-9-1 Kamimeguro, Meguro-ku, Tokyo, Japan 153-0051

Phone: 81-3-5773-3850

ON Semiconductor Website: <http://onsemi.com>

Order Literature: <http://www.onsemi.com/litorder>

For additional information, please contact your
local Sales Representative.

BZX84C2V4LT1/D