

# TC7PA04FU

## Dual Inverter with 3.6 V Tolerant Input and Output

### Features

- Operating voltage range:  $V_{CC} = 1.8\sim 3.6\text{ V}$
- High-speed operation:  $t_{pd} = 2.8\text{ ns (max)}$  at  $V_{CC} = 3.0\sim 3.6\text{ V}$   
 $t_{pd} = 3.7\text{ ns (max)}$  at  $V_{CC} = 2.3\sim 2.7\text{ V}$   
 $t_{pd} = 7.4\text{ ns (max)}$  at  $V_{CC} = 1.8\text{ V}$
- High-level output current:  
 $I_{OH}/I_{OL} = \pm 24\text{ mA (min)}$  at  $V_{CC} = 3.0\text{ V}$   
 $I_{OH}/I_{OL} = \pm 18\text{ mA (min)}$  at  $V_{CC} = 2.3\text{ V}$   
 $I_{OH}/I_{OL} = \pm 6\text{ mA (min)}$  at  $V_{CC} = 1.8\text{ V}$
- High latch-up immunity:  $\pm 300\text{ mA}$
- High ESD: Higher than or equal to  $\pm 200\text{ V (JEITA)}$
- Higher than or equal to  $\pm 2000\text{ V (MIL)}$
- 3.6-V tolerant function and power-down protection provided on all inputs and outputs

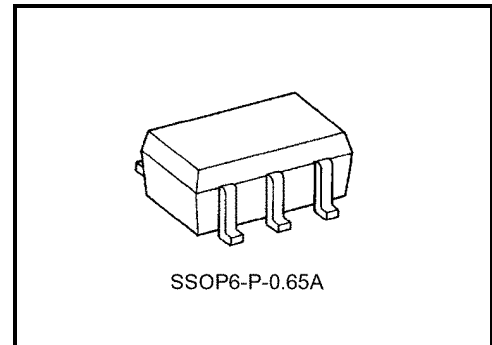

Weight: 0.0068 g (typ.)

### Maximum Ratings ( $T_a = 25^\circ\text{C}$ )

Characteristics	Symbol	Value	Unit
Power supply voltage	$V_{CC}$	$-0.5\sim 6$	V
DC input voltage	$V_{IN}$	$-0.5\sim 6$	V
DC output voltage	$V_{OUT}$	$-0.5\sim 6$ (Note 1)	V
		$-0.5\sim V_{CC} + 0.5$ (Note 2)	
Input diode current	$I_{IK}$	$-50$	mA
Output diode current	$I_{OK}$	$\pm 50$ (Note 3)	mA
DC output current	$I_{OUT}$	$\pm 50$	mA
Power dissipation	$P_D$	200	mW
DC $V_{CC}$ /ground current	$I_{CC}$	$\pm 100$	mA
Storage temperature	$T_{stg}$	$-65\sim 150$	$^\circ\text{C}$

Note 1:  $V_{CC} = 0\text{ V}$

Note 2: High or Low state. The  $I_{OUT}$  maximum rating must be adhere to.

Note 3:  $V_{OUT} < \text{GND}$ ,  $V_{OUT} > V_{CC}$

### Marking

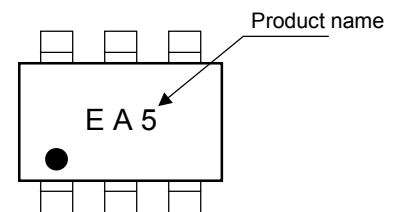

### Pin Assignment (top view)

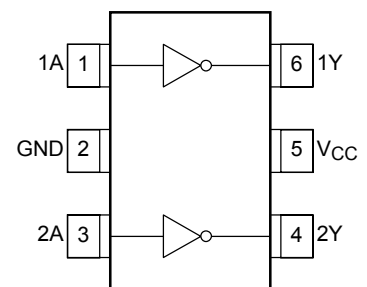

## Truth Table

A	Y
L	H
H	L

## IEC Logic Symbol

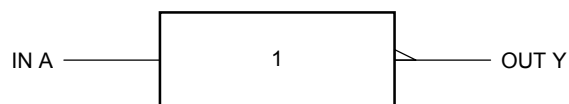

## Recommended Operating Conditions

Characteristics	Symbol	Value	Unit
Power supply voltage	$V_{CC}$	1.8~3.6	V
		1.2~3.6 (Note 4)	
Input voltage	$V_{IN}$	-0.3~3.6	V
Output voltage	$V_{OUT}$	0~3.6 (Note 5)	V
		0~ $V_{CC}$ (Note 6)	
Output Current	$I_{OH}/I_{OL}$	$\pm 24$ (Note 7)	mA
		$\pm 18$ (Note 8)	
		$\pm 6$ (Note 9)	
Operating temperature	$T_{opr}$	-40~85	°C
Input rise and fall time	$d_t/d_v$	0~10 (Note 10)	ns/V

Note 4: Data retention only

Note 5:  $V_{CC} = 0$  V

Note 6: High or Low state

Note 7:  $V_{CC} = 3.0\sim 3.6$  V

Note 8:  $V_{CC} = 2.3\sim 2.7$  V

Note 9:  $V_{CC} = 1.8$  V

Note 10:  $V_{IN} = 0.8\sim 2.0$  V,  $V_{CC} = 3.0$  V

## DC Electrical Characteristics (Ta = -40~85°C, 2.7 V < VCC ≤ 3.6 V)

Characteristics	Symbol	Test Condition		VCC (V)	Min	Max	Unit
High-Level Input Voltage	V <sub>IH</sub>	—		2.7~3.6	2.0	—	V
Low-Level Input Voltage	V <sub>IL</sub>	—		2.7~3.6	—	0.8	
High-Level Output Voltage	V <sub>OH</sub>	V <sub>IN</sub> = V <sub>IL</sub>	I <sub>OH</sub> = -100 μA	2.7~3.6	V <sub>CC</sub> - 0.2	—	V
			I <sub>OH</sub> = -12 mA	2.7	2.2	—	
			I <sub>OH</sub> = -18 mA	3.0	2.4	—	
			I <sub>OH</sub> = -24 mA	3.0	2.2	—	
Low-Level Output Voltage	V <sub>OL</sub>	V <sub>IN</sub> = V <sub>IH</sub>	I <sub>OL</sub> = 100 μA	2.7~3.6	—	0.2	V
			I <sub>OL</sub> = 12 mA	2.7	—	0.4	
			I <sub>OL</sub> = 18 mA	3.0	—	0.4	
			I <sub>OL</sub> = 24 mA	3.0	—	0.55	
Input Leakage Current	I <sub>IN</sub>	V <sub>IN</sub> = 0~3.6 V		2.7~3.6	—	±5.0	μA
Power-off Leakage Current	I <sub>OFF</sub>	V <sub>IN</sub> , V <sub>OUT</sub> = 0~3.6 V		0	—	10.0	μA
Quiescent Supply Current	I <sub>CC</sub>	V <sub>IN</sub> = V <sub>CC</sub> or GND		2.7~3.6	—	20.0	μA
		V <sub>CC</sub> ≤ (V <sub>IN</sub> , V <sub>OUT</sub> ) ≤ 3.6 V		2.7~3.6	—	±20.0	
Increase in I <sub>CC</sub> per Input	ΔI <sub>CC</sub>	V <sub>IH</sub> = V <sub>CC</sub> - 0.6 V		2.7~3.6	—	750	

## DC Characteristics (Ta = -40~85°C, 2.3 V ≤ VCC ≤ 2.7 V)

Characteristics	Symbol	Test Condition		VCC (V)	Min	Max	Unit
High-Level Input Voltage	V <sub>IH</sub>	—		2.3~2.7	1.6	—	V
Low-Level Input Voltage	V <sub>IL</sub>	—		2.3~2.7	—	0.7	
High-Level Output Voltage	V <sub>OH</sub>	V <sub>IN</sub> = V <sub>IL</sub>	I <sub>OH</sub> = -100 μA	2.3~2.7	V <sub>CC</sub> - 0.2	—	V
			I <sub>OH</sub> = -6 mA	2.3	2.0	—	
			I <sub>OH</sub> = -12 mA	2.3	1.8	—	
			I <sub>OH</sub> = -18 mA	2.3	1.7	—	
Low-Level Output Voltage	V <sub>OL</sub>	V <sub>IN</sub> = V <sub>IH</sub>	I <sub>OL</sub> = 100 μA	2.3~2.7	—	0.2	V
			I <sub>OL</sub> = 12 mA	2.3	—	0.4	
			I <sub>OL</sub> = 18 mA	2.3	—	0.6	
Input Leakage Current	I <sub>IN</sub>	V <sub>IN</sub> = 0~3.6 V		2.3~2.7	—	±5.0	μA
Power-off Leakage Current	I <sub>OFF</sub>	V <sub>IN</sub> , V <sub>OUT</sub> = 0~3.6 V		0	—	10.0	μA
Quiescent Supply Current	I <sub>CC</sub>	V <sub>IN</sub> = V <sub>CC</sub> or GND		2.3~2.7	—	20.0	μA
		V <sub>CC</sub> ≤ (V <sub>IN</sub> , V <sub>OUT</sub> ) ≤ 3.6 V		2.3~2.7	—	±20.0	

## DC Characteristics (Ta = -40~85°C, 1.8 V ≤ VCC < 2.3 V)

Characteristics	Symbol	Test Condition		VCC (V)	Min	Max	Unit
High-Level Input Voltage	V <sub>IH</sub>	—		1.8~2.3	0.7 × V <sub>CC</sub>	—	V
Low-Level Input Voltage	V <sub>IL</sub>	—		1.8~2.3	—	0.2 × V <sub>CC</sub>	
High-Level Output Voltage	V <sub>OH</sub>	V <sub>IN</sub> = V <sub>IL</sub>	I <sub>OH</sub> = -100 μA	1.8	V <sub>CC</sub> - 0.2	—	V
			I <sub>OH</sub> = -6 mA	1.8	1.4	—	
Low-Level Output Voltage	V <sub>OL</sub>	V <sub>IN</sub> = V <sub>IH</sub>	I <sub>OL</sub> = 100 μA	1.8	—	0.2	
			I <sub>OL</sub> = 6 mA	1.8	—	0.3	
Input Leakage Current	I <sub>IN</sub>	V <sub>IN</sub> = 0~3.6 V		1.8	—	±5.0	μA
Power-off Leakage Current	I <sub>OFF</sub>	V <sub>IN</sub> , V <sub>OUT</sub> = 0~3.6 V		0	—	10.0	μA
Quiescent Supply Current	I <sub>CC</sub>	V <sub>IN</sub> = V <sub>CC</sub> or GND		1.8	—	20.0	μA
		V <sub>CC</sub> ≤ (V <sub>IN</sub> , V <sub>OUT</sub> ) ≤ 3.6 V		1.8	—	±20.0	

## AC Electrical Characteristics (Ta = -40~85°C, input t<sub>r</sub> = t<sub>f</sub> = 2.0 ns, C<sub>L</sub> = 30 pF, R<sub>L</sub> = 500 Ω)

Characteristics	Symbol	Test Condition		VCC (V)	Min	Max	Unit
Propagation delay time	t <sub>pLH</sub> t <sub>pHL</sub>	(Figure 1 and 2)		1.8	1.0	7.4	ns
				2.5 ± 0.2	0.8	3.7	
				3.3 ± 0.3	0.6	2.8	

For C<sub>L</sub> = 50 pF, add approximately 300 ps to the AC maximum specification.

**Dynamic Switching Characteristics (Ta = 25°C, input tr = tf = 2.0 ns, CL = 30 pF)**

Characteristics	Symbol	Test Condition		TYP.	Unit	
			VCC (V)			
Quiet Output Maximum Dynamic VOL	VOLP	VIN = 1.8 V, VIL = 0 V	(Note 11)	1.8	0.25	ns
		VIN = 2.5 V, VIL = 0 V	(Note 11)	2.5	0.6	
		VIN = 3.3 V, VIL = 0 V	(Note 11)	3.3	0.8	
Quiet Output Minimum Dynamic VOL	VOLV	VIN = 1.8 V, VIL = 0 V	(Note 11)	1.8	-0.25	ns
		VIN = 2.5 V, VIL = 0 V	(Note 11)	2.5	-0.6	
		VIN = 3.3 V, VIL = 0 V	(Note 11)	3.3	-0.8	
Quiet Output Minimum Dynamic VOH	VOLP	VIN = 1.8 V, VIL = 0 V	(Note 11)	1.8	1.5	ns
		VIN = 2.5 V, VIL = 0 V	(Note 11)	2.5	1.9	
		VIN = 3.3 V, VIL = 0 V	(Note 11)	3.3	2.2	

Note 11: Characteristics guaranteed by design.

**Capacitive Characteristics (Ta = 25°C)**

Characteristics	Symbol	Test Condition		TYP.	Unit
			VCC (V)		
Input Capacitance	CIN	—		5	pF
Power Dissipation Capacitance	CPD	fIN = 10 MHz	(Note 12)	18	pF

Note 12: CPD is defined as the value of the internal equivalent capacitance which is calculated from the operating current consumption without load.

Average operating current can be obtained by the equation:

$$I_{CC} (opr.) = C_{PD} \cdot V_{CC} \cdot f_{IN} + I_{CC}/2$$

Figure 1 Test Circuit

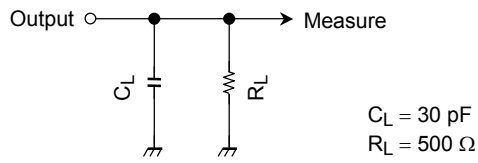

**AC Waveforms**

Figure 2  $t_{pLH}$ ,  $t_{pHL}$

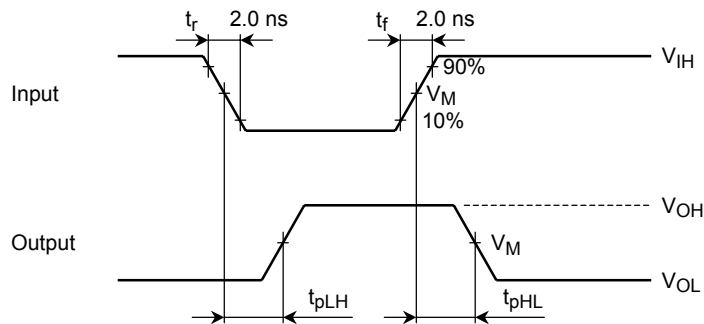

Symbol	$V_{CC}$		
	$3.3 \pm 0.3 \text{ V}$	$2.5 \pm 0.2 \text{ V}$	1.8 V
$V_{IH}$	2.7 V	$V_{CC}$	$V_{CC}$
$V_M$	1.5 V	$V_{CC}/2$	$V_{CC}/2$

**Package Dimensions**

SSOP6-P-0.65A

Unit: mm

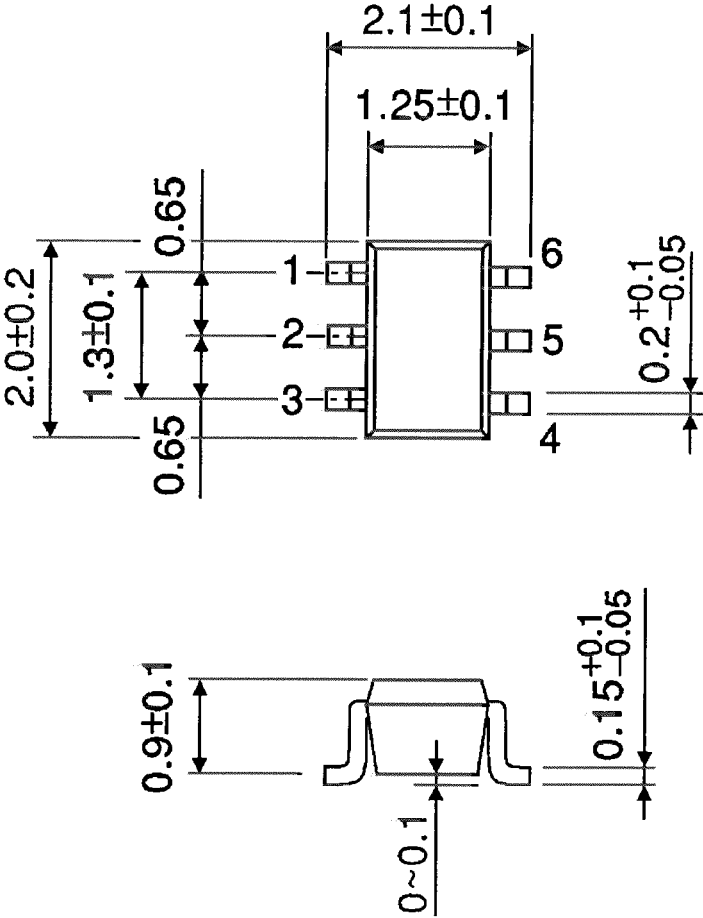

Weight: 0.0068 g (typ.)

**RESTRICTIONS ON PRODUCT USE**

000707EBA

- TOSHIBA is continually working to improve the quality and reliability of its products. Nevertheless, semiconductor devices in general can malfunction or fail due to their inherent electrical sensitivity and vulnerability to physical stress. It is the responsibility of the buyer, when utilizing TOSHIBA products, to comply with the standards of safety in making a safe design for the entire system, and to avoid situations in which a malfunction or failure of such TOSHIBA products could cause loss of human life, bodily injury or damage to property.  
In developing your designs, please ensure that TOSHIBA products are used within specified operating ranges as set forth in the most recent TOSHIBA products specifications. Also, please keep in mind the precautions and conditions set forth in the "Handling Guide for Semiconductor Devices," or "TOSHIBA Semiconductor Reliability Handbook" etc..
- The TOSHIBA products listed in this document are intended for usage in general electronics applications (computer, personal equipment, office equipment, measuring equipment, industrial robotics, domestic appliances, etc.). These TOSHIBA products are neither intended nor warranted for usage in equipment that requires extraordinarily high quality and/or reliability or a malfunction or failure of which may cause loss of human life or bodily injury ("Unintended Usage"). Unintended Usage include atomic energy control instruments, airplane or spaceship instruments, transportation instruments, traffic signal instruments, combustion control instruments, medical instruments, all types of safety devices, etc.. Unintended Usage of TOSHIBA products listed in this document shall be made at the customer's own risk.
- The products described in this document are subject to the foreign exchange and foreign trade laws.
- The information contained herein is presented only as a guide for the applications of our products. No responsibility is assumed by TOSHIBA CORPORATION for any infringements of intellectual property or other rights of the third parties which may result from its use. No license is granted by implication or otherwise under any intellectual property or other rights of TOSHIBA CORPORATION or others.
- The information contained herein is subject to change without notice.