

- Monolithic Silicon IC Containing Photodiode, Operational Amplifier, and Feedback Components
- Converts Light Intensity to a Voltage
- High Irradiance Responsivity, Typically 137 mV/($\mu\text{W}/\text{cm}^2$) at $\lambda_p = 635 \text{ nm}$ (TSL250R)
- Compact 3-Lead Clear Plastic Package
- Single Voltage Supply Operation
- Low Dark (Offset) Voltage....10mV Max
- Low Supply Current.....1.1 mA Typical
- Wide Supply-Voltage Range.... 2.7 V to 5.5 V
- Replacements for TSL250, TSL251, and TSL252

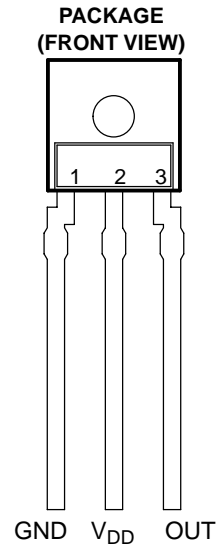

Description

The TSL250R, TSL251R, and TSL252R are light-to-voltage optical sensors, each combining a photodiode and a transimpedance amplifier (feedback resistor = 16 M Ω , 8 M Ω , and 2.8 M Ω respectively) on a single monolithic IC. Output voltage is directly proportional to the light intensity (irradiance) on the photodiode. These devices have improved amplifier offset-voltage stability and low power consumption and are supplied in a 3-lead clear plastic sidelooker package with an integral lens

Functional Block Diagram

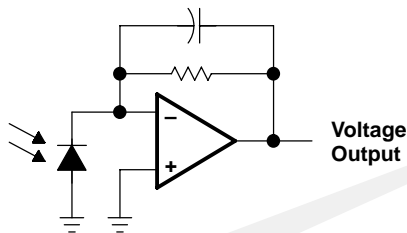

Terminal Functions

TERMINAL NAME	NO.	DESCRIPTION
GND	1	Ground (substrate). All voltages are referenced to GND.
OUT	3	Output voltage
V _{DD}	2	Supply voltage

TSL250R, TSL251R, TSL252R LIGHT-TO-VOLTAGE OPTICAL SENSORS

TAOS028A – MAY 2001

Absolute Maximum Ratings over operating free-air temperature range (unless otherwise noted)†

Supply voltage, V_{DD} (see Note 1)	6 V
Output current, I_O	± 10 mA
Duration of short-circuit current at (or below) 25°C (see Note 2)	5 s
Operating free-air temperature range, T_A	-25°C to 85°C
Storage temperature range, T_{stg}	-25°C to 85°C
Lead temperature 1,6 mm (1/16 inch) from case for 10 seconds	240°C

† Stresses beyond those listed under “absolute maximum ratings” may cause permanent damage to the device. These are stress ratings only, and functional operation of the device at these or any other conditions beyond those indicated under “recommended operating conditions” is not implied. Exposure to absolute-maximum-rated conditions for extended periods may affect device reliability.

- NOTES: 1. All voltages are with respect to GND.
2. Output may be shorted to supply.

Recommended Operating Conditions

	MIN	NOM	MAX	UNIT
Supply voltage, V_{DD}	2.7		5.5	V
Operating free-air temperature, T_A	0		70	°C

Electrical Characteristics at $V_{DD} = 5$ V, $T_A = 25^\circ\text{C}$, $\lambda_p = 635$ nm, $R_L = 10$ k Ω (unless otherwise noted) (see Notes 3, 4, and 5)

PARAMETER	TEST CONDITIONS	TSL250R			TSL251R			TSL252R			UNIT
		MIN	TYP	MAX	MIN	TYP	MAX	MIN	TYP	MAX	
V_D Dark voltage	$E_e = 0$	0	4	10	0	4	10	0	4	10	mV
V_{OM} Maximum output voltage	$V_{DD} = 4.5$ V	3.0	3.3		3.0	3.3		3.0	3.3		V
V_O Output voltage	$E_e = 14.6 \mu\text{W}/\text{cm}^2$	1.5	2	2.5							V
	$E_e = 38.5 \mu\text{W}/\text{cm}^2$				1.5	2	2.5				
	$E_e = 196 \mu\text{W}/\text{cm}^2$							1.5	2	2.5	
α_{VO} Temperature coefficient of output voltage (V_O)	$E_e = 14.6 \mu\text{W}/\text{cm}^2$, $T_A = 0^\circ\text{C}$ to 70°C	1.6									mV/°C
		0.08									%/°C
	$E_e = 38.5 \mu\text{W}/\text{cm}^2$, $T_A = 0^\circ\text{C}$ to 70°C				1.6						mV/°C
					0.08						%/°C
	$E_e = 196 \mu\text{W}/\text{cm}^2$, $T_A = 0^\circ\text{C}$ to 70°C							1.6			mV/°C
								0.08			%/°C
N_e Irradiance responsivity	$\lambda_p = 635$ nm, See Notes 5 and 7	137			52			10.2			mV/($\mu\text{W}/\text{cm}^2$)
	$\lambda_p = 880$ nm, See Notes 6 and 7	127			48			9.4			
I_{DD} Supply current	$E_e = 14.6 \mu\text{W}/\text{cm}^2$	1.1			1.7						mA
	$E_e = 38.5 \mu\text{W}/\text{cm}^2$				1.1			1.7			
	$E_e = 196 \mu\text{W}/\text{cm}^2$							1.1			

- NOTES: 3. Measurements are made with $R_L = 10$ k Ω between output and ground.
4. Optical measurements are made using small-angle incident radiation from an LED optical source.
5. The input irradiance E_e is supplied by an AlInGaP LED with peak wavelength $\lambda_p = 635$ nm
6. The input irradiance E_e is supplied by a GaAlAs LED with peak wavelength $\lambda_p = 880$ nm
7. Irradiance responsivity is characterized over the range $V_O = 0.05$ to 2.9 V. The best-fit straight line of Output Voltage V_O versus irradiance E_e over this range will typically have a positive extrapolated V_O value for $E_e = 0$.

Dynamic Characteristics at $T_A = 25^\circ\text{C}$ (see Figure 1)

PARAMETER	TEST CONDITIONS	TSL250R			TSL251R			TSL252R			UNIT
		MIN	TYP	MAX	MIN	TYP	MAX	MIN	TYP	MAX	
t_r Output pulse rise time	$V_{DD} = 5\text{ V}$, $\lambda_p = 635\text{ nm}$		260		70		7				μs
t_f Output pulse fall time	$V_{DD} = 5\text{ V}$, $\lambda_p = 635\text{ nm}$		260		70		7				μs
V_n Output noise voltage	$V_{DD} = 5\text{ V}$, $E_e = 0$, $f = 1000\text{ Hz}$		0.8		0.7		0.6				$\mu\text{V}/\sqrt{\text{Hz}}$

PARAMETER MEASUREMENT INFORMATION

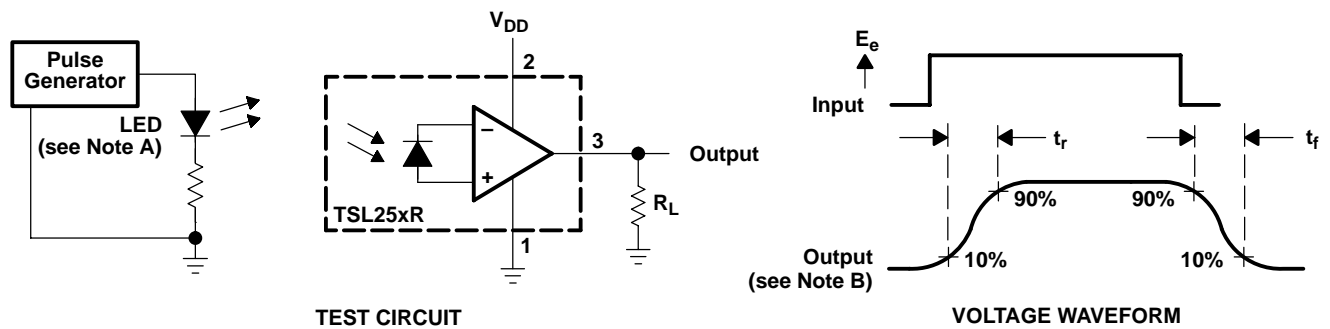

NOTES: A. The input irradiance is supplied by a pulsed AlInGaP light-emitting diode with the following characteristics: $\lambda_p = 635\text{ nm}$, $t_r < 1\ \mu\text{s}$, $t_f < 1\ \mu\text{s}$.

B. The output waveform is monitored on an oscilloscope with the following characteristics: $t_r < 100\text{ ns}$, $Z_i \geq 1\ \text{M}\Omega$, $C_i \leq 20\ \text{pF}$.

Figure 1. Switching Times

TSL250R, TSL251R, TSL252R LIGHT-TO-VOLTAGE OPTICAL SENSORS

TAOS028A – MAY 2001

TYPICAL CHARACTERISTICS

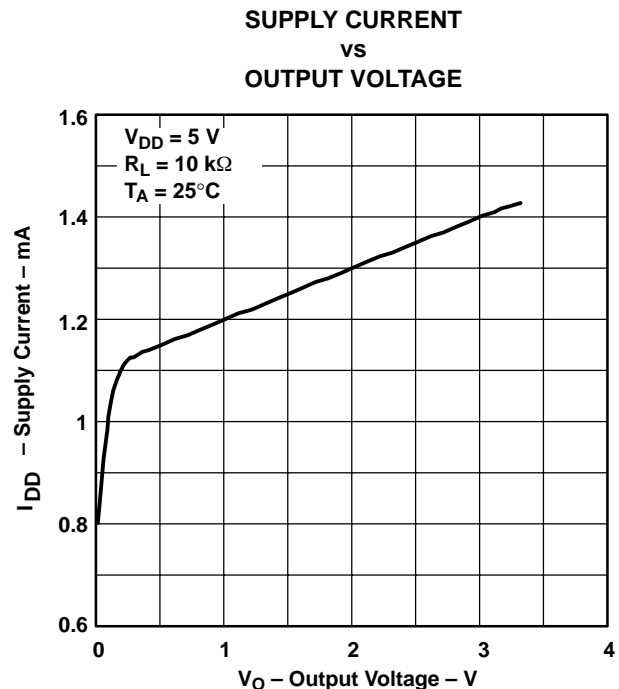
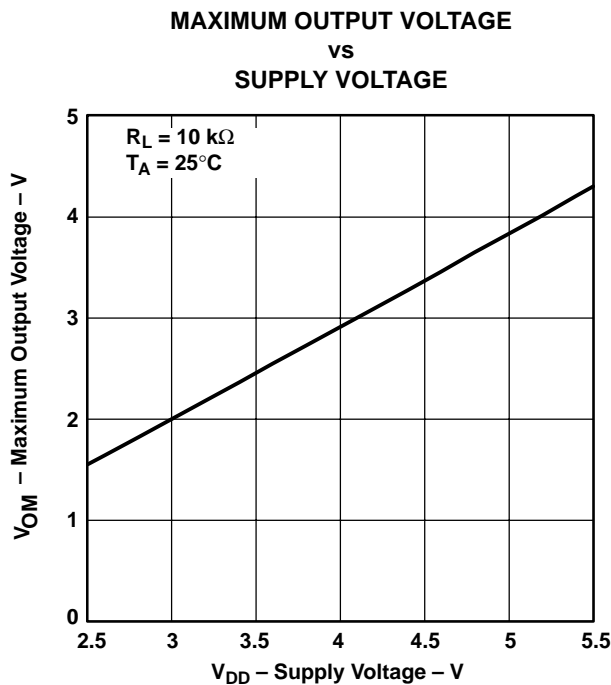
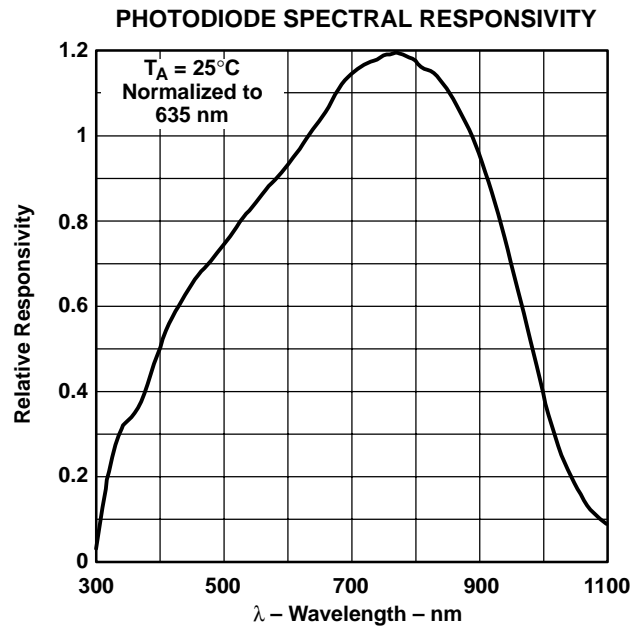
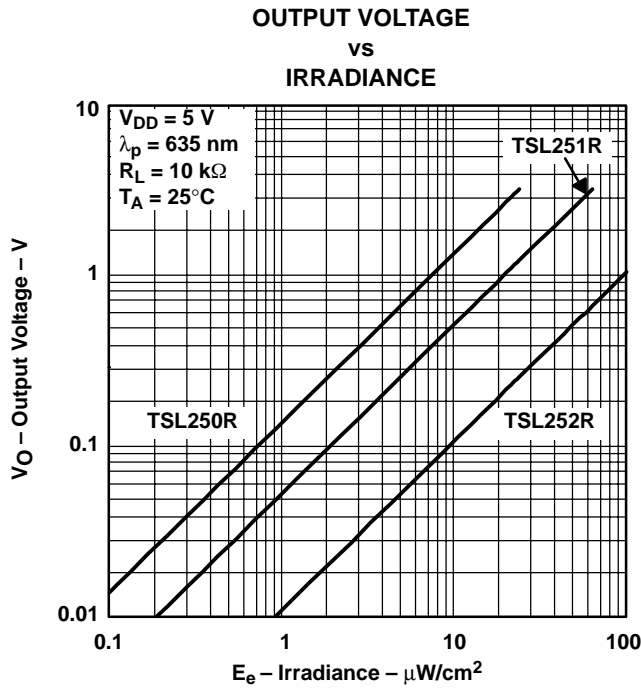

TYPICAL CHARACTERISTICS

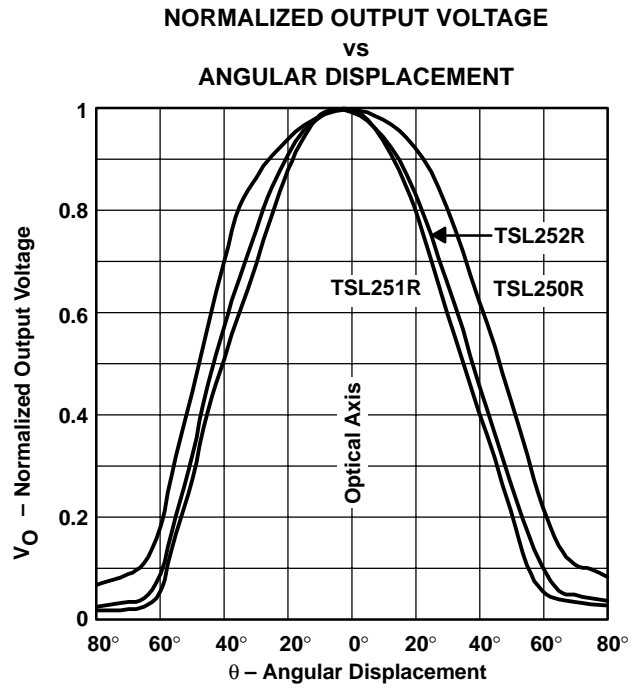

Figure 6

TSL250R, TSL251R, TSL252R LIGHT-TO-VOLTAGE OPTICAL SENSORS

TAOS028A – MAY 2001

MECHANICAL INFORMATION

The device is supplied in a clear plastic three-lead package. The integrated photodiode active area is typically 1,0 mm² (0.0016 in²) for TSL250R, 0,5 mm² (0.00078 in²) for the TSL251R, and 0,26 mm² (0.0004 in²) for the TSL252R.

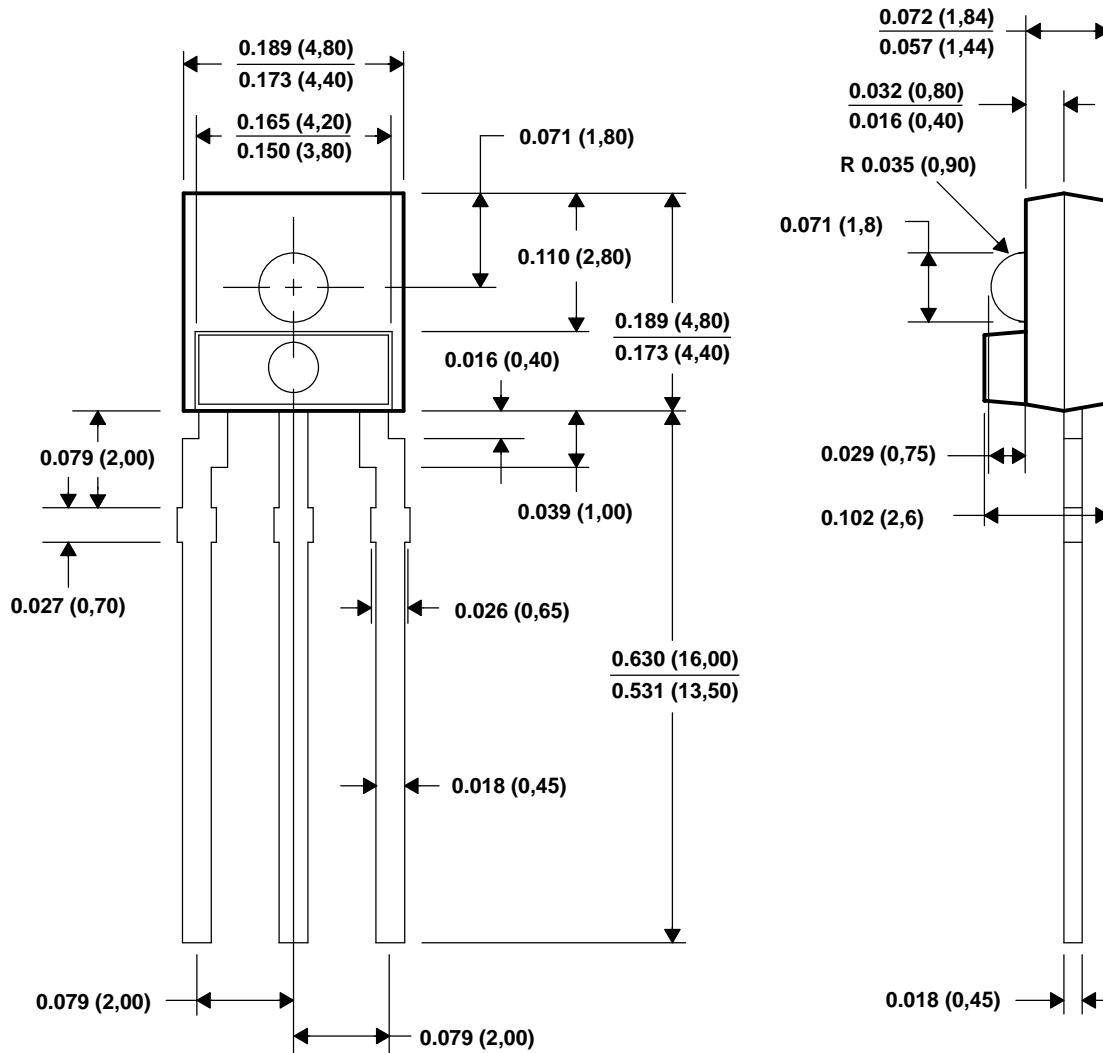

Figure 7. Package Configuration

- NOTES:
- All linear dimensions are in inches (millimeters).
 - This drawing is subject to change without notice.
 - All dimensions apply before solder dip.
 - Package body is a clear nonfilled optically transparent material
 - Index of refraction of clear plastic is 1.55.

PRODUCTION DATA — information in this document is current at publication date. Products conform to specifications in accordance with the terms of Texas Advanced Optoelectronic Solutions, Inc. standard warranty. Production processing does not necessarily include testing of all parameters.

NOTICE

Texas Advanced Optoelectronic Solutions, Inc. (TAOS) reserves the right to make changes to the products contained in this document to improve performance or for any other purpose, or to discontinue them without notice. Customers are advised to contact TAOS to obtain the latest product information before placing orders or designing TAOS products into systems.

TAOS assumes no responsibility for the use of any products or circuits described in this document or customer product design, conveys no license, either expressed or implied, under any patent or other right, and makes no representation that the circuits are free of patent infringement. TAOS further makes no claim as to the suitability of its products for any particular purpose, nor does TAOS assume any liability arising out of the use of any product or circuit, and specifically disclaims any and all liability, including without limitation consequential or incidental damages.

TEXAS ADVANCED OPTOELECTRONIC SOLUTIONS, INC. PRODUCTS ARE NOT DESIGNED OR INTENDED FOR USE IN CRITICAL APPLICATIONS IN WHICH THE FAILURE OR MALFUNCTION OF THE TAOS PRODUCT MAY RESULT IN PERSONAL INJURY OR DEATH. USE OF TAOS PRODUCTS IN LIFE SUPPORT SYSTEMS IS EXPRESSLY UNAUTHORIZED AND ANY SUCH USE BY A CUSTOMER IS COMPLETELY AT THE CUSTOMER'S RISK.

TAOS, the TAOS logo, and Texas Advanced Optoelectronic Solutions are trademarks of Texas Advanced Optoelectronic Solutions Incorporated.

