

RECTIFIER STACK (CENTER TAP)

1J2C1 600V 2A

MAXIMUM RATINGS

CHARACTERISTIC		SYMBOL	RATING	UNIT
Repetitive Peak Reverse Voltage	1B2C1, 1B2Z1	V _{RRM}	100	V
	1D2C1, 1D2Z1		200	
	1G2C1, 1G2Z1		400	
	1J2C1, 1J2Z1		600	
Average Output Rectified Current		I _o	2.0	A
Peak One Cycle Surge Forward Current		I _{FSM}	60(50Hz)	A
Junction Temperature		T _j	-40~150	°C
Storage Temperature Range		T _{stg}	-40~150	°C

ELECTRICAL CHARACTERISTICS

CHARACTERISTIC	SYMBOL	CONDITION	MIN.	TYP.	MAX.	UNIT
Peak Forward Voltage	V _{FM}	I _{FM} =2.0A, T _a =25°C	-	-	1.2	V
Repetitive Peak Reverse Current	I _{RRM}	V _{RRM} =Rated, T _j =150°C	-	-	0.4	mA

POLARITY

1. CATHODE COMMON

1B2C1 1G2C1
1D2C1 1J2C1

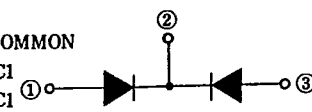

2. ANODE COMMON

1B2Z1 1G2Z1
1D2Z1 1J2Z1

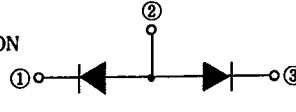
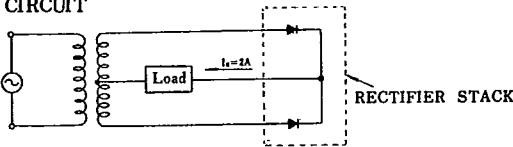
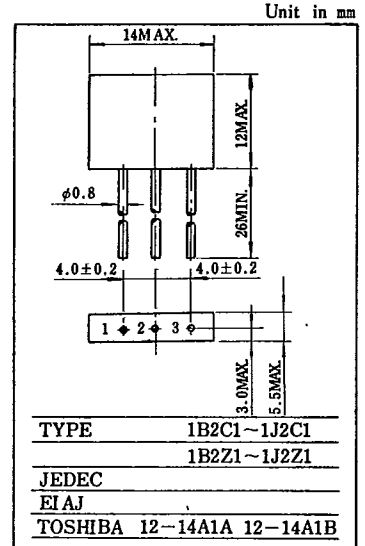

Fig.1 NORMAL CIRCUIT



- Notes : 1. Soldering : 6 mm is the minimum to be kept between case and soldering part.
2. Lead Bending : 6 mm is the minimum to be kept from the case when bend the lead wire.



I_o - T_a MAX

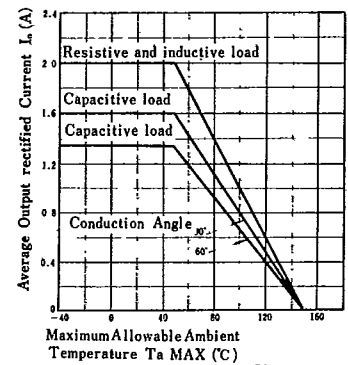

4J2C41 600V 4A

MAXIMUM RATINGS

CHARACTERISTIC		SYMBOL	RATING	Unit
Repetitive Peak Reverse Voltage	4B2C41, 4B2Z41	V _{RRM}	100	V
	4D2C41, 4D2Z41		200	
	4G2C41, 4G2Z41		400	
	4J2C41, 4J2Z41		600	
Average Output Rectified Current		I _o	4	A
Peak One Cycle Surge Forward Current (Non-Repetitive) (T _a =25°C)		I _{FSM}	250(50Hz)	A
Junction Temperature		T _j	-20~150	°C
Storage Temperature Range		T _{stg}	-20~140	°C

ELECTRICAL CHARACTERISTICS

CHARACTERISTIC	SYMBOL	CONDITION	MIN.	TYP.	MAX.	UNIT
Peak Forward Voltage	V _{FM}	I _{FM} =22A T _a =25°C	-	-	1.2	V
Repetitive Peak Reverse Current	I _{RRM}	V _{RRM} =Rated T _j =150°C	-	-	2.0	mA

POLARITY

1. CATHODE COMMON

4B2C41 4G2C41
4D2C41 4J2C41

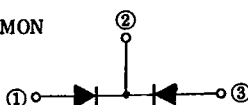

2. ANODE COMMON

4B2Z41 4G2Z41
4D2Z41 4J2Z41

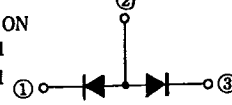
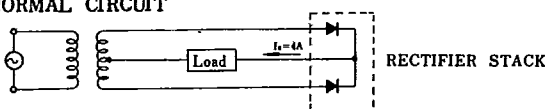
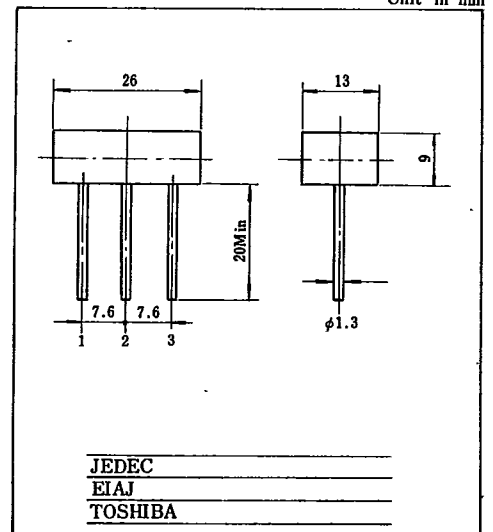

Fig.1 NORMAL CIRCUIT



- Notes : 1. Soldering : 6 mm is the minimum to be kept between case and soldering part.
2. Lead Bending : 6 mm is the minimum to be kept from the case when bend the lead wire.



I_o - T_a MAX

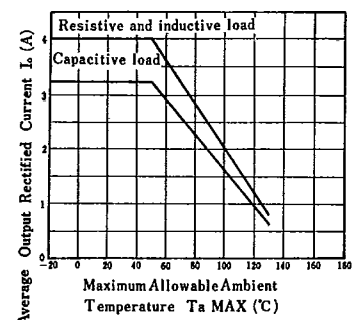

STACKS