

TOSHIBA GTR MODULE SILICON N CHANNEL IGBT

MG75Q2YS50

HIGH POWER SWITCHING APPLICATIONS

MOTOR CONTROL APPLICATIONS

- High Input Impedance
- High Speed : $t_f = 0.3 \mu s$ (Max.)
@Inductive Load
- Low Saturation Voltage
: $V_{CE(sat)} = 3.6V$ (Max.)
- Enhancement-Mode
- Includes a Complete Half Bridge in One Package.
- The Electrodes are Isolated from Case.

EQUIVALENT CIRCUIT

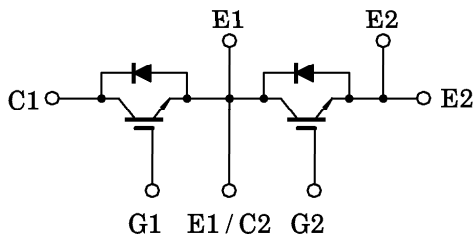

Unit in mm

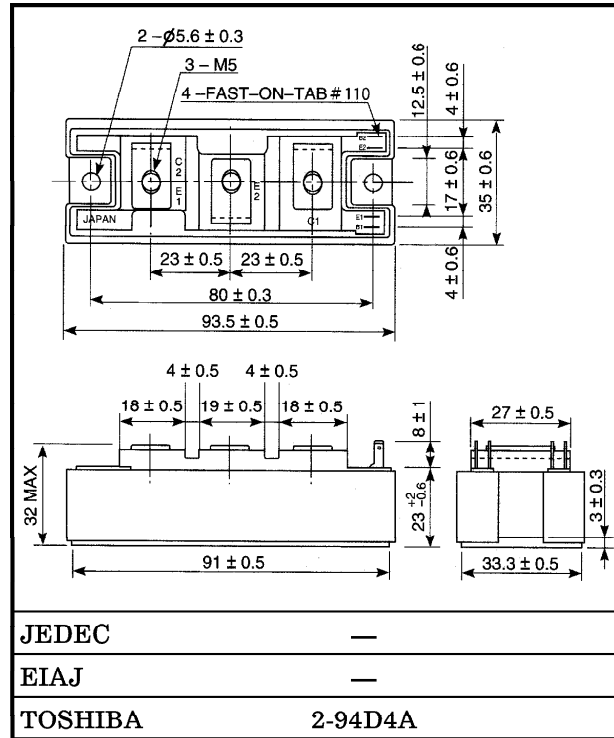

Weight : 202g

MAXIMUM RATINGS (Ta = 25°C)

CHARACTERISTIC	SYMBOL	RATING	UNIT
Collector-Emitter Voltage	V_{CES}	1200	V
Gate-Emitter Voltage	V_{GES}	±20	V
Collector Current	DC	I_C (25°C / 80°C)	100 / 75
	1ms	I_{CP} (25°C / 80°C)	200 / 150
Forward Current	DC	I_F	75
	1ms	I_{FM}	150
Collector Power Dissipation (Tc = 25°C)	P_C	600	W
Junction Temperature	T_j	150	°C
Storage Temperature Range	T_{stg}	-40~125	°C
Isolation Voltage	V_{Isol}	2500 (AC 1minute)	V
Screw Torque (Terminal / Mounting)	—	3 / 3	N·m

961001EAA2

● TOSHIBA is continually working to improve the quality and the reliability of its products. Nevertheless, semiconductor devices in general can malfunction or fail due to their inherent electrical sensitivity and vulnerability to physical stress. It is the responsibility of the buyer, when utilizing TOSHIBA products, to observe standards of safety, and to avoid situations in which a malfunction or failure of a TOSHIBA product could cause loss of human life, bodily injury or damage to property. In developing your designs, please ensure that TOSHIBA products are used within specified operating ranges as set forth in the most recent products specifications. Also, please keep in mind the precautions and conditions set forth in the TOSHIBA Semiconductor Reliability Handbook.

ELECTRICAL CHARACTERISTICS (Ta = 25°C)

CHARACTERISTIC		SYMBOL	TEST CONDITION	MIN.	TYP.	MAX.	UNIT
Gate Leakage Current		I_{GES}	$V_{GE} = \pm 20V, V_{CE} = 0$	—	—	± 500	nA
Collector Cut-off Current		I_{CES}	$V_{CE} = 1200V, V_{GE} = 0$	—	—	1.0	mA
Gate-Emitter Cut-off Voltage		$V_{GE} (off)$	$I_C = 75mA, V_{CE} = 5V$	3.0	—	6.0	V
Collector-Emitter Saturation Voltage		$V_{CE} (sat)$	$I_C = 75A, V_{GE} = 15V$	$T_j = 25^\circ C$	—	2.8	3.6
				$T_j = 125^\circ C$	—	3.1	4.0
Input Capacitance		C_{ies}	$V_{CE} = 10V, V_{GE} = 0, f = 1MHz$	—	8.5	—	nF
Switching Time	Turn-on Delay Time	$t_d (on)$	Inductive Load $V_{CC} = 600V$ $I_C = 75A$ $V_{GE} = \pm 15V$ $R_G = 16\Omega$ (Note 1)	—	0.05	—	μs
	Rise Time	t_r		—	0.05	—	
	Turn-on Time	t_{on}		—	0.2	—	
	Turn-off Delay Time	$t_d (off)$		—	0.5	—	
	Fall Time	t_f		—	0.1	0.3	
	Turn-off Time	t_{off}		—	0.6	—	
Forward Voltage		V_F	$I_F = 75A, V_{GE} = 0$	—	2.4	3.5	V
Reverse Recovery Time		t_{rr}	$I_F = 75A, V_{GE} = -10V$ $di/dt = 700A/\mu s$ (Note 1)	—	0.1	0.25	μs
Thermal Resistance		$R_{th} (j-c)$	Transistor Stage	—	—	0.2	$^\circ C/W$
			Diode Stage	—	—	0.47	

Note 1 : Switching Time and Reverse Recovery Time Test Circuit & Timing Chart

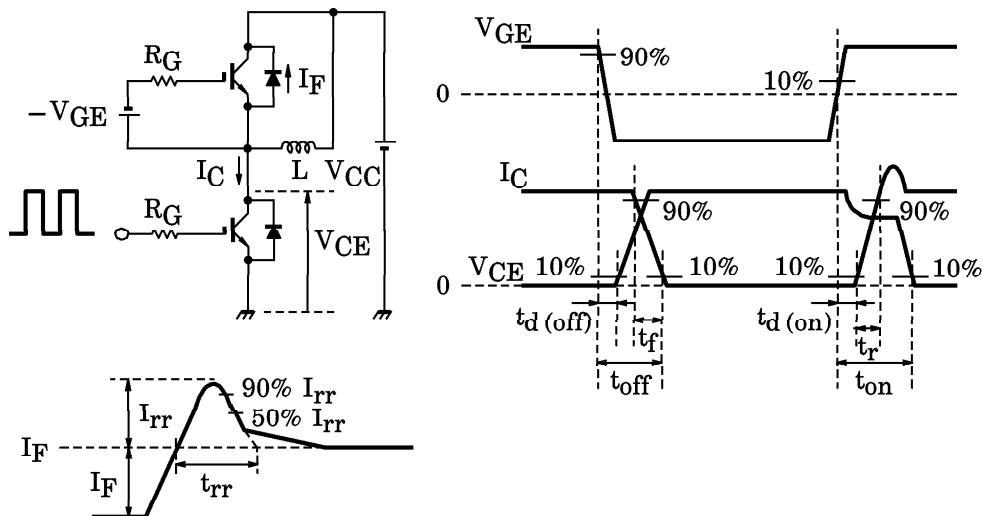

961001EAA2'

- The information contained herein is presented only as a guide for the applications of our products. No responsibility is assumed by TOSHIBA CORPORATION for any infringements of intellectual property or other rights of the third parties which may result from its use. No license is granted by implication or otherwise under any intellectual property or other rights of TOSHIBA CORPORATION or others.
- The information contained herein is subject to change without notice.

