

TENTATIVE TOSHIBA MOS DIGITAL INTEGRATED CIRCUIT SILICON GATE CMOS
262,144-WORD BY 16-BIT STATIC RAM

DESCRIPTION

The TC554161FTL is a 4,194,304-bit static random access memory (SRAM) organized as 262,144 words by 16 bits. Fabricated using Toshiba's CMOS Silicon gate process technology, this device operates from a single 3 to 5.5 V power supply. Advanced circuit technology provides both high speed and low power at an operating current of 10 mA/MHz (typ) and a minimum cycle time of 70 ns. It is automatically placed in low-power mode at 4 μ A standby current (max) when chip enable (\overline{CE}) is asserted high. There are two control inputs. \overline{CE} is used to select the device and for data retention control, and output enable (\overline{OE}) provides fast memory access. Data byte control pin (\overline{LB} , \overline{UB}) provides lower and upper byte access. This device is well suited to various microprocessor system applications where high speed, low power and battery backup are required. The TC554161FTL is available in a plastic 54-pin thin-small-outline package (TSOP).

FEATURES

- Low-power dissipation
Operating: 55 mW/MHz (typical)
- Standby current of 8 μ A (maximum) at $T_a = 25^\circ\text{C}$
- Single power supply voltage of 3 to 5.5 V
- Power down features using \overline{CE} .
- Data retention supply voltage of 2 to 5.5 V
- Direct TTL compatibility for all inputs and outputs

Access Times (maximum):

	5 V \pm 10%			3.0 V to 5.5 V
	-70V	-85V	-10V	-70V/-85V/-10V
Access Time	70 ns	85 ns	100 ns	150 ns
\overline{CE} Access Time	70 ns	85 ns	100 ns	150 ns
\overline{OE} Access Time	35 ns	45 ns	50 ns	75 ns

- Package:
TSOP II 54-P-400 -0.80 (FTL) (Weight: 0.55 g typ)

PIN ASSIGNMENT (TOP VIEW)

NC	1	54	A4
A3	2	53	A5
A2	3	52	A6
A1	4	51	A7
A0	5	50	NC
I/O16	6	49	I/O1
I/O15	7	48	I/O2
V _{DD}	8	47	V _{DD}
GND	9	46	GND
I/O14	10	45	I/O3
I/O13	11	44	I/O4
\overline{UB}	12	43	\overline{LB}
\overline{CE}	13	42	\overline{OE}
OP	14	41	OP
R/W	15	40	NC
I/O12	16	39	I/O5
I/O11	17	38	I/O6
GND	18	37	GND
V _{DD}	19	36	V _{DD}
I/O10	20	35	I/O7
I/O9	21	34	I/O8
NC	22	33	A8
A17	23	32	A9
A16	24	31	A10
A15	25	30	A11
A14	26	29	A12
A13	27	28	NC

(Normal pinout)

PIN NAMES

A0 to A17	Address Inputs
I/O1 to I/O16	Data Inputs/Outputs
\overline{CE}	Chip Enable
R/W	Read/Write Control
\overline{OE}	Output Enable
\overline{LB} , \overline{UB}	Data Byte Control Input
V _{DD}	Power
GND	Ground
NC	No Connection
OP*	Option

*: OP pin must be open or connected to GND.

961001EBA1

- TOSHIBA is continually working to improve the quality and the reliability of its products. Nevertheless, semiconductor devices in general can malfunction or fail due to their inherent electrical sensitivity and vulnerability to physical stress. It is the responsibility of the buyer, when utilizing TOSHIBA products, to observe standards of safety, and to avoid situations in which a malfunction or failure of a TOSHIBA product could cause loss of human life, bodily injury or damage to property. In developing your designs, please ensure that TOSHIBA products are used within specified operating ranges as set forth in the most recent products specifications. Also, please keep in mind the precautions and conditions set forth in the TOSHIBA Semiconductor Reliability Handbook.
- The products described in this document are subject to foreign exchange and foreign trade control laws.
- The information contained herein is presented only as a guide for the applications of our products. No responsibility is assumed by TOSHIBA CORPORATION for any infringements of intellectual property or other rights of the third parties which may result from its use. No license is granted by implication or otherwise under any intellectual property or other rights of TOSHIBA CORPORATION or others.
- The information contained herein is subject to change without notice.

BLOCK DIAGRAM

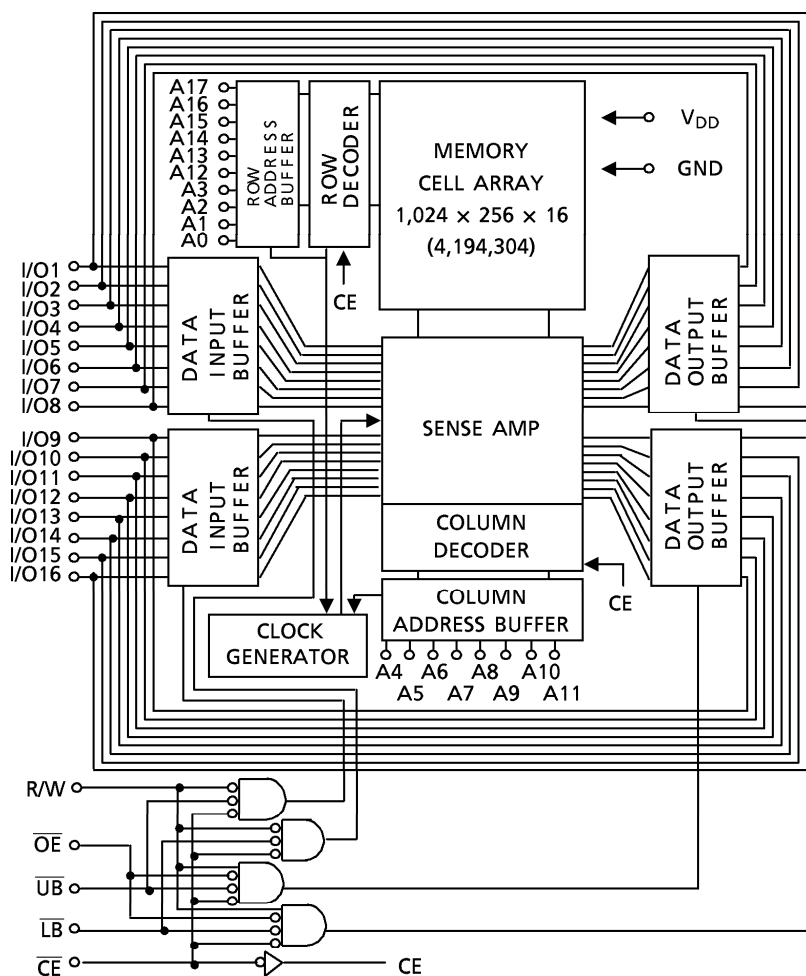

MAXIMUM RATINGS

SYMBOL	RATING	VALUE	UNIT
V _{DD}	Power Supply Voltage	- 0.3 to 7.0	V
V _{IN}	Input Voltage	- 0.3 * to 7.0	V
V _{I/O}	Input/Output Voltage	- 0.5 * to V _{DD} + 0.5	V
P _D	Power Dissipation	0.6	W
T _{solder}	Soldering Temperature (10 s)	260	°C
T _{strg}	Storage Temperature	- 55 to 150	°C
T _{opr}	Operating Temperature	0 to 70	°C

* - 3.0 V when measured at a pulse width of 30 ns

DC RECOMMENDED OPERATING CONDITIONS (Ta = 0° to 70°C)

SYMBOL	PARAMETER	5 V ± 10%			3.0 to 5.5 V			UNIT
		MIN	TYP	MAX	MIN	TYP	MAX	
V _{DD}	Power Supply Voltage	4.5	5.0	5.5	3.0	5.0	5.5	V
V _{IH}	Input High Voltage	2.2	-	V _{DD} + 0.3	V _{DD} - 0.2 V	-	V _{DD} + 0.3	V
V _{IL}	Input Low Voltage	- 0.3 *	-	0.8	- 0.3 *	-	0.2	V
V _{DH}	Data Retention Supply Voltage	2.0	-	5.5	2.0	-	5.5	V

* - 3.0 V when measured at a pulse width of 30 ns

DC CHARACTERISTICS ($T_a = 0^\circ \text{ to } 70^\circ\text{C}$, $V_{DD} = 5 \text{ V} \pm 10\%$)

SYMBOL	PARAMETER	TEST CONDITION		MIN	TYP	MAX	UNIT	
I_{IL}	Input Leakage Current	$V_{IN} = 0 \text{ V to } V_{DD}$		-	-	± 1.0	μA	
I_{LO}	Output Leakage Current	$\overline{CE} = V_{IH}$ or $R/W = V_{IL}$ or $\overline{OE} = V_{IH}$ $V_{OUT} = 0 \text{ V to } V_{DD}$		-	-	± 1.0	μA	
I_{OH}	Output High Current	$V_{OH} = 2.4 \text{ V}$		- 1.0	-	-	mA	
I_{OL}	Output Low Current	$V_{OL} = 0.4 \text{ V}$		2.1	-	-	mA	
I_{DDO1}	Operating Current	$\overline{CE} = V_{IL}$ $R/W = V_{IH}$, $I_{OUT} = 0 \text{ mA}$ Other Inputs = V_{IH}/V_{IL}	Tcycle	70 ns	-	-	110	mA
				85 ns, 100 ns	-	-	100	
				1 μs	-	15	-	
I_{DDO2}	Operating Current	$\overline{CE} = 0.2 \text{ V}$ $R/W = V_{DD} - 0.2 \text{ V}$, $I_{OUT} = 0 \text{ mA}$ Other Inputs = $V_{DD} - 0.2 \text{ V}/0.2 \text{ V}$	Tcycle	70 ns	-	-	100	mA
				85 ns, 100 ns	-	-	90	
				1 μs	-	10	-	
I_{DDS1}	Standby Current	$\overline{CE} = V_{IH}$		-	-	3	mA	
I_{DDS2}		$\overline{CE} = V_{DD} - 0.2 \text{ V}$	$V_{DD} = 2 \text{ to } 5.5 \text{ V}$	$T_a = 25^\circ\text{C}$	-	4	8	μA
				$T_a = 0^\circ \text{ to } 70^\circ\text{C}$	-	-	60	
		$V_{DD} = 3.0 \text{ V}$	$T_a = 25^\circ\text{C}$	-	2	-		
			$T_a = 0^\circ \text{ to } 40^\circ\text{C}$	-	-	6		
		$T_a = 0 \text{ to } 70^\circ\text{C}$	-	-	30			

DC CHARACTERISTICS ($T_a = 0^\circ \text{ to } 70^\circ\text{C}$, $V_{DD} = 3.3 \text{ V} \pm 0.3 \text{ V}$)

SYMBOL	PARAMETER	TEST CONDITION		MIN	TYP	MAX	UNIT	
I_{IL}	Input Leakage Current	$V_{IN} = 0 \text{ V to } V_{DD}$		-	-	± 1.0	μA	
I_{LO}	Output Leakage Current	$\overline{CE} = V_{IH}$ or $R/W = V_{IL}$ or $\overline{OE} = V_{IH}$ $V_{OUT} = 0 \text{ V to } V_{DD}$		-	-	± 1.0	μA	
I_{OH}	Output High Current	$V_{OH} = V_{DD} - 0.2 \text{ V}$		- 1.0	-	-	mA	
I_{OL}	Output Low Current	$V_{OL} = 0.2 \text{ V}$		0.1	-	-	mA	
I_{DDO2}	Operating Current	$\overline{CE} = 0.2 \text{ V}$ $R/W = V_{DD} - 0.2 \text{ V}$, $I_{OUT} = 0 \text{ mA}$ Other Inputs = $V_{DD} - 0.2 \text{ V}/0.2 \text{ V}$	Tcycle	min	-	-	35	mA
				1 μs	-	5	-	
I_{DDS2}	Standby Current	$\overline{CE} = V_{DD} - 0.2 \text{ V}$	$V_{DD} = 3.3 \text{ V} \pm 0.3 \text{ V}$	$T_a = 25^\circ\text{C}$	-	2	4	μA
				$T_a = 0^\circ \text{ to } 70^\circ\text{C}$	-	-	40	
			$V_{DD} = 3.3 \text{ V}$	$T_a = 25^\circ\text{C}$	-	2	-	
				$T_a = 0^\circ \text{ to } 40^\circ\text{C}$	-	-	8	
		$T_a = 0^\circ \text{ to } 70^\circ\text{C}$	-	-	35			

CAPACITANCE ($T_a = 25^\circ\text{C}$, $f = 1 \text{ MHz}$)

SYMBOL	PARAMETER	TEST CONDITION	MIN	TYP	MAX	UNIT
C_{IN}	Input Capacitance	$V_{IN} = \text{GND}$	-	-	10	pF
C_{OUT}	Output Capacitance	$V_{OUT} = \text{GND}$	-	-	10	pF

Note: This parameter is periodically sampled and is not 100% tested.

OPERATING MODE

MODE	\overline{CE}	\overline{OE}	R/W	\overline{LB}	\overline{UB}	I/O1 to I/O8	I/O9 to I/O16	POWER
Read	L	L	H	L	L	Output	Output	I_{DDO}
				H	L	High-Z	Output	I_{DDO}
				L	H	Output	High-Z	I_{DDO}
Write	L	x	L	L	L	Input	Input	I_{DDO}
				H	L	High-Z	Input	I_{DDO}
				L	H	Input	High-Z	I_{DDO}
Outputs Disable	L	H	H	x	x	High-Z	High-Z	I_{DDO}
	L	x	x	H	H			
Standby	H	x	x	x	x	High-Z	High-Z	I_{DDS}

x = don't care
H = logic high
L = logic low

AC CHARACTERISTICS AND OPERATING CONDITIONS (Ta = 0° to 70°C, VDD = 5 V ± 10%)

READ CYCLE

SYMBOL	PARAMETER	TC554161FTL						UNIT
		-70V		-85V		-10V		
		MIN	MAX	MIN	MAX	MIN	MAX	
t _{RC}	Read Cycle Time	70	–	85	–	100	–	ns
t _{ACC}	Address Access Time	–	70	–	85	–	100	
t _{CO}	Chip Enable Access Time	–	70	–	85	–	100	
t _{OE}	Output Enable Access Time	–	35	–	45	–	50	
t _{BA}	Data Byte Control Access Time	–	35	–	45	–	50	
t _{OH}	Output Data Hold Time	10	–	10	–	10	–	
t _{COE}	Chip Enable Low to Output Active	10	–	10	–	10	–	
t _{OEE}	Output Enable Low to Output Active	5	–	5	–	5	–	
t _{BE}	Data Byte Control Low to Output Active	5	–	5	–	5	–	
t _{OD}	Chip Enable High to Output High-Z	–	25	–	30	–	35	
t _{ODO}	Output Enable High to Output High-Z	–	25	–	30	–	35	
t _{BD}	Data Byte Control High to Output High-Z	–	25	–	30	–	35	

WRITE CYCLE

SYMBOL	PARAMETER	TC554161FTL						UNIT
		-70V		-85V		-10V		
		MIN	MAX	MIN	MAX	MIN	MAX	
t _{WC}	Write Cycle Time	70	–	85	–	100	–	ns
t _{WP}	Write Pulse Width	50	–	55	–	60	–	
t _{CW}	Chip Enable to End of Write	60	–	70	–	80	–	
t _{BW}	Data Byte Control to End of Write	50	–	55	–	60	–	
t _{AS}	Address Setup Time	0	–	0	–	0	–	
t _{WR}	Write Recovery Time	0	–	0	–	0	–	
t _{DS}	Data Setup Time	30	–	35	–	40	–	
t _{DH}	Data Hold Time	0	–	0	–	0	–	
t _{OEW}	R/W High to Output Active	5	–	5	–	5	–	
t _{ODW}	R/W Low to Output High-Z	–	25	–	30	–	35	

AC TEST CONDITIONS

Output load: 100 pF + one TTL gate
 Input pulse level: 0.6 V, 2.4 V
 Timing measurements: 1.5 V
 Reference level: 1.5 V
 t_R, t_F: 5 ns

AC CHARACTERISTICS AND OPERATING CONDITIONS ($T_a = 0^\circ$ to 70°C , $V_{DD} = 3$ to 5.5 V)

READ CYCLE

SYMBOL	PARAMETER	MIN	MAX	
t_{RC}	Read Cycle Time	150	-	ns
t_{ACC}	Address Access Time	-	150	
t_{CO}	Chip Enable Access Time	-	150	
t_{OE}	Output Enable Access Time	-	75	
t_{BA}	Data Byte Control Access Time	-	75	
t_{OH}	Output Data Hold Time	10	-	
t_{COE}	Chip Enable Low to Output Active	10	-	
t_{OEE}	Output Enable Low to Output Active	5	-	
t_{BE}	Data Byte Control Low to Output Active	5	-	
t_{OD}	Chip Enable High to Output High-Z	-	50	
t_{ODO}	Output Enable High to Output High-Z	-	50	
t_{BD}	Data Byte Control High to Output High-Z	-	50	

WRITE CYCLE

SYMBOL	PARAMETER	MIN	MAX	UNIT
t_{WC}	Write Cycle Time	150	-	ns
t_{WP}	Write Pulse Width	100	-	
t_{CW}	Chip Enable to End of Write	120	-	
t_{BW}	Data Byte Control to End of Write	100	-	
t_{AS}	Address Setup Time	0	-	
t_{WR}	Write Recovery Time	0	-	
t_{DS}	Data Setup Time	60	-	
t_{DH}	Data Hold Time	0	-	
t_{OEW}	R/W High to Output Active	5	-	
t_{ODW}	R/W Low to Output High-Z	-	50	

AC TEST CONDITIONS

Output load: 100 pF (including jig)

Input pulse level: 0.2 V, $V_{DD} - 0.2\text{ V}$

Timing measurements: 1.5 V

Reference level: 1.5 V

t_R, t_F : 5 ns

TIMING DIAGRAMS
READ CYCLE (See Note 1)

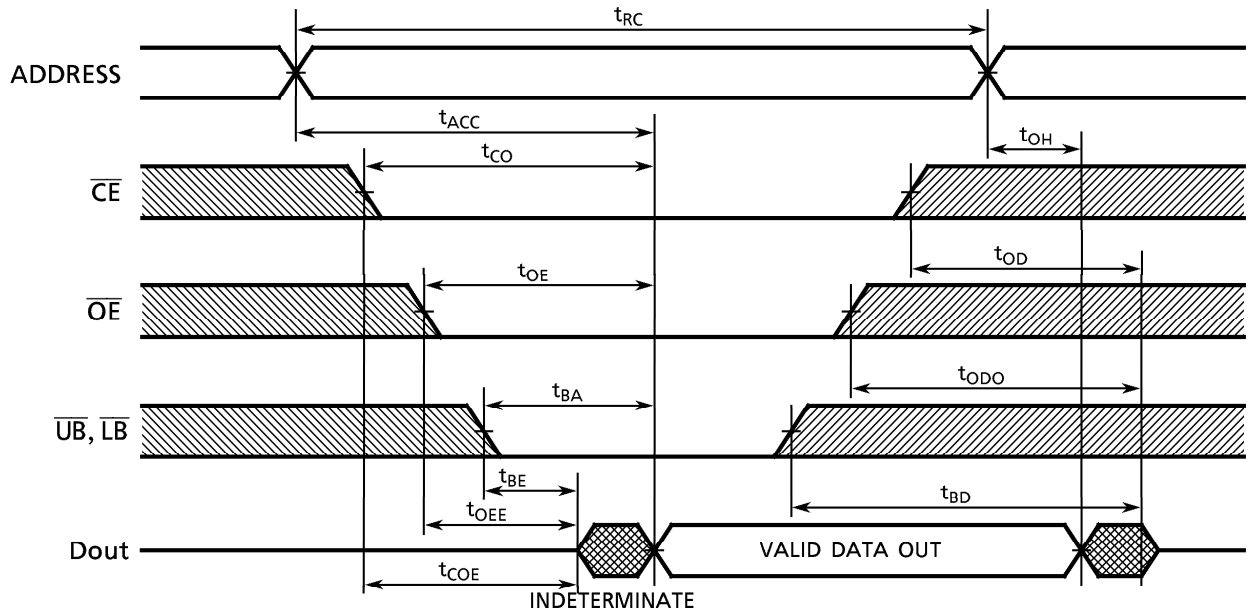

WRITE CYCLE 1 (R/W CONTROLLED) (See Note 4)

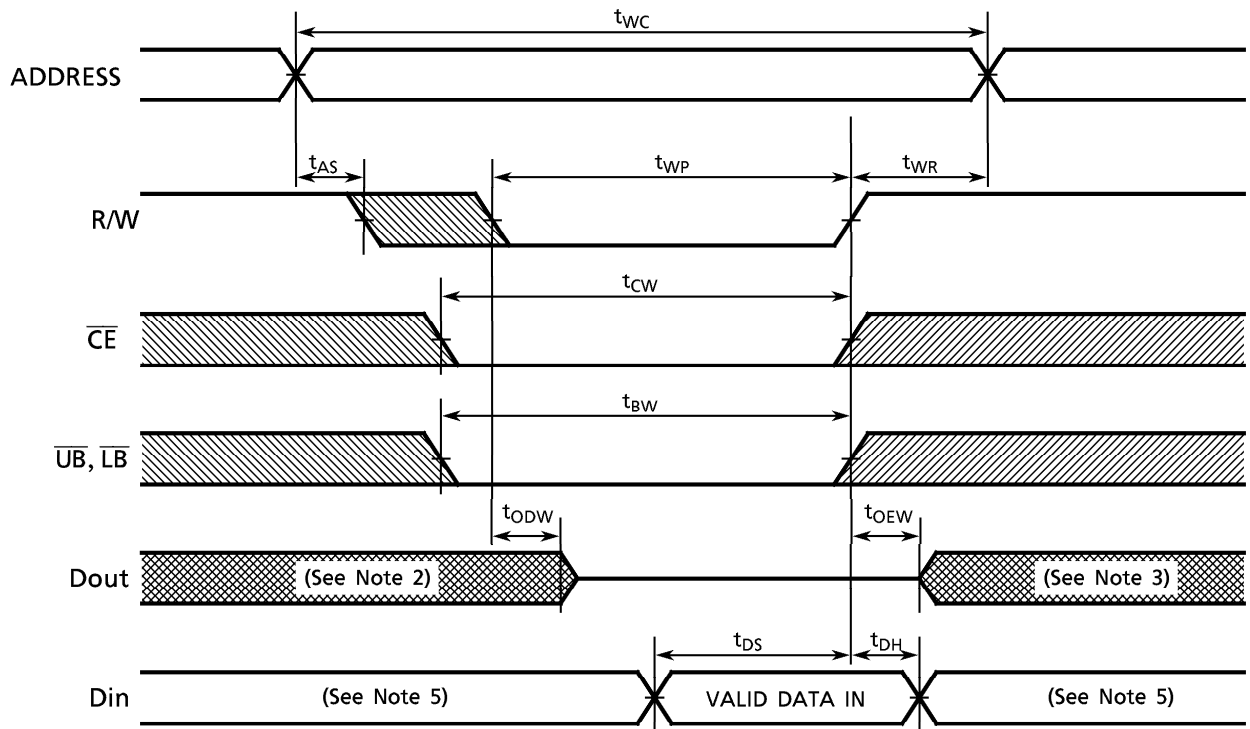

WRITE CYCLE 2 (\overline{CE} CONTROLLED) (See Note 4)

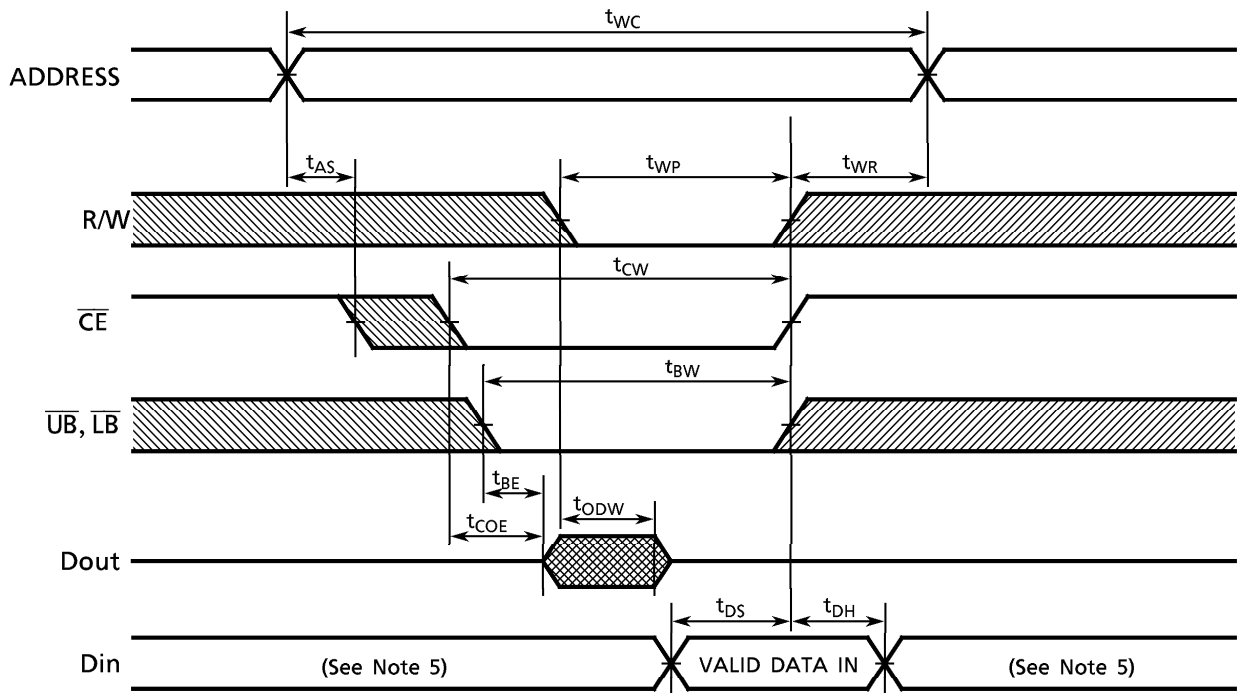

WRITE CYCLE 3 (\overline{UB} , \overline{LB} CONTROLLED) (See Note 4)

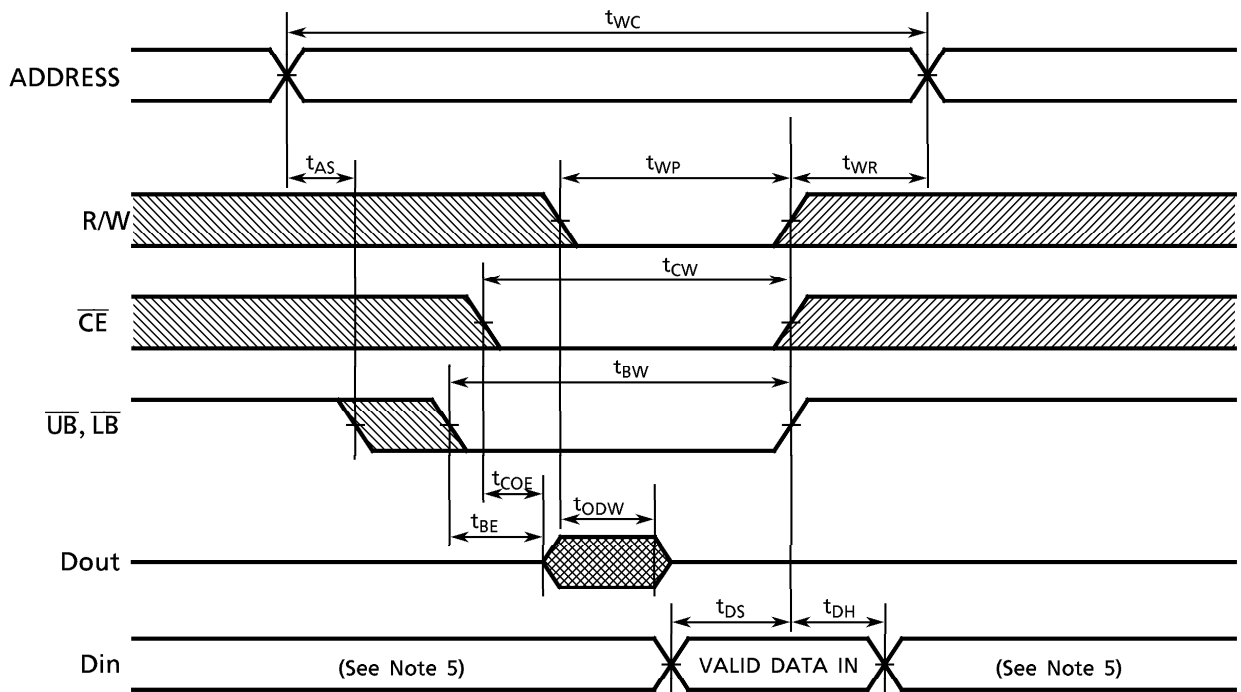

Note: (1) R/W remains HIGH for the read cycle.

(2) If \overline{CE} goes LOW coincident with or after R/W goes LOW, the outputs will remain at high impedance.

(3) If \overline{CE} goes HIGH coincident with or before R/W goes HIGH, the outputs will remain at high impedance.

(4) If \overline{OE} is HIGH during the write cycle, the outputs will remain at high impedance.

(5) Because I/O signals may be in the output state at this time, input signals of reverse polarity must not be applied.

DATA RETENTION CHARACTERISTICS (Ta = 0° to 70°C)

SYMBOL	PARAMETER	MIN	TYP	MAX	UNIT	
V _{DH}	Data Retention Supply Voltage	2.0	–	5.5	V	
I _{DDS2}	Standby Current	V _{DH} = 3.3 V	–	–	35*	μA
		V _{DH} = 5.5 V	–	–	60	
t _{CDR}	Chip Deselect to Data Retention Mode Time	0	–	–	nS	
t _R	Recovery Time	5	–	–	mS	

* 8 μA (max) at Ta = 0° to 40°C

CE CONTROLLED DATA RETENTION MODE

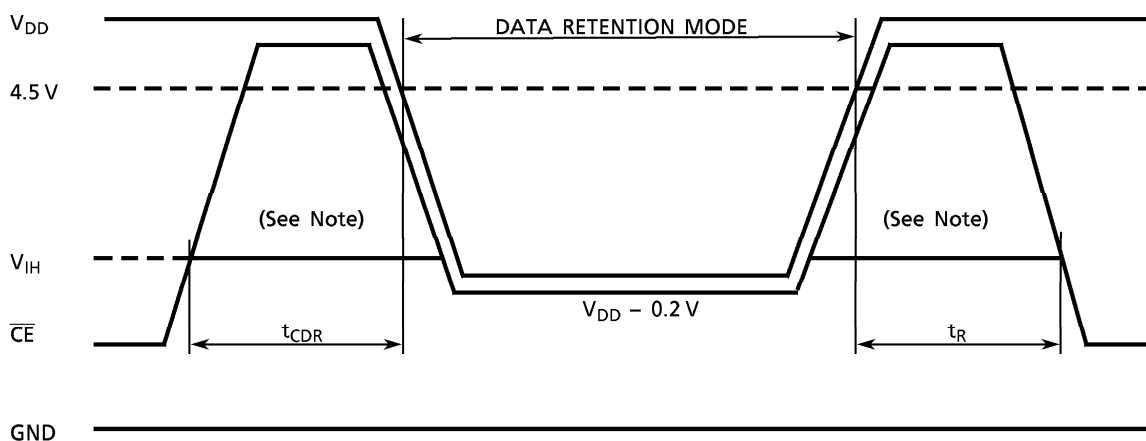

Note: When \overline{CE} is operating at the V_{IH} level (2.2 V), the operating current is given by I_{DDS1} during the transition of V_{DD} from 4.5 to 2.4 V.

PACKAGE DIMENSIONS (TSOPII 54-P-400-0.80)

Units in mm

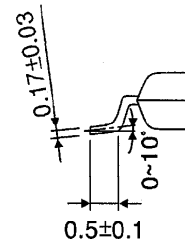
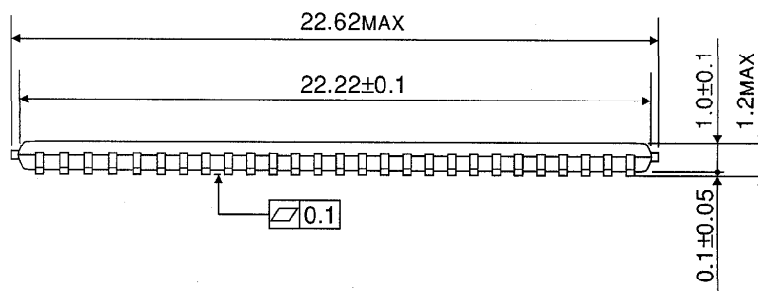
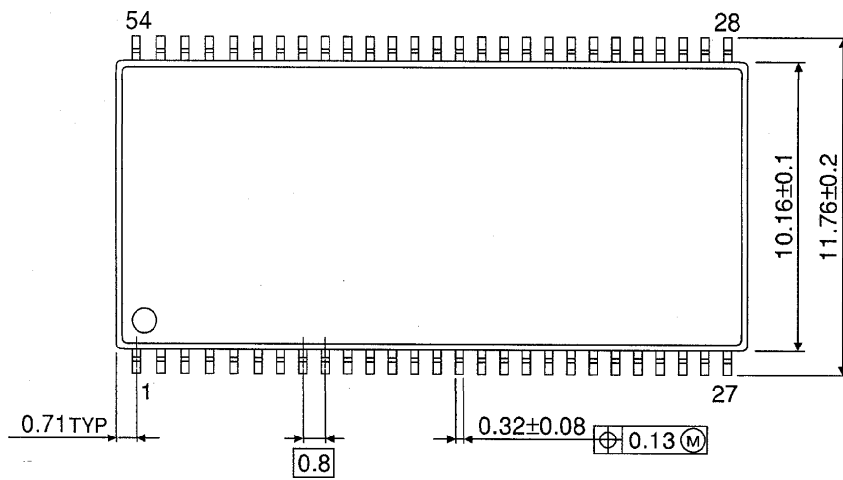

Weight: 0.55 g (typ)