

TOSHIBA PHOTOCOUPLER PHOTO RELAY

TLP227A, TLP227A-2

CORDLESS TELEPHONE

PBX

MODEM

The TOSHIBA TLP227A series consist of a gallium arsenide infrared emitting diode optically coupled to a photo-MOS FET in a plastic DIP package.

The TLP227A series are a bi-directional switch, which can replace mechanical relays in many applications.

FEATURES

- TLP227A : 4 pin DIP (DIP4)
1 Channel Type (1 Form A)
- TLP227A-2 : 8 pin DIP (DIP8)
2 Channel Type (2 Form A)
- Peak Off-State Voltage : 60 V (MIN.)
- Trigger LED Current : 3 mA (MAX.)
- On-State Current : 500 mA (MAX.)
- On-State Resistance : 2 Ω (MAX.)
- Isolation Voltage : 2500 Vrms (MIN.)
- UL Recognized : UL1577, File No. E67349

PIN CONFIGURATION (TOP VIEW)

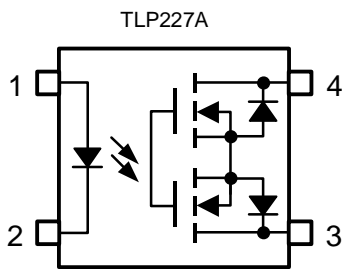

1 : ANODE
2 : CATHODE
3 : DRAIN
4 : DRAIN

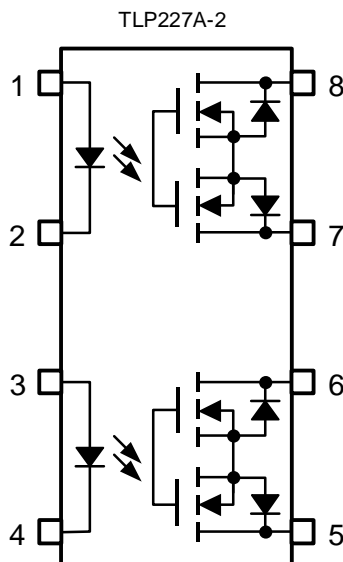

1, 3 : ANODE
2, 4 : CATHODE
5 : DRAIN D1
6 : DRAIN D2
7 : DRAIN D3
8 : DRAIN D4

Unit: mm

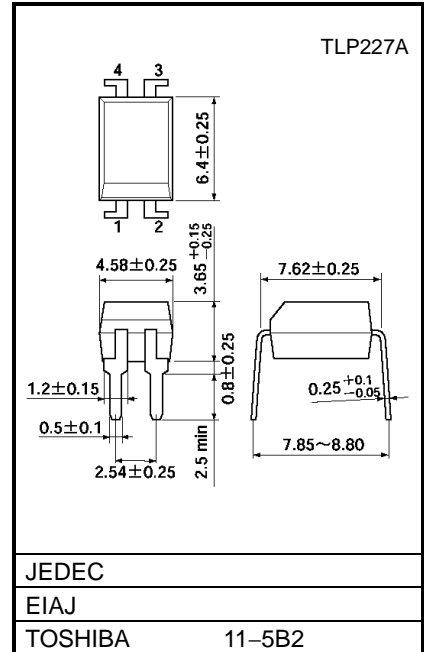

Weight: 0.26 g

Unit: mm

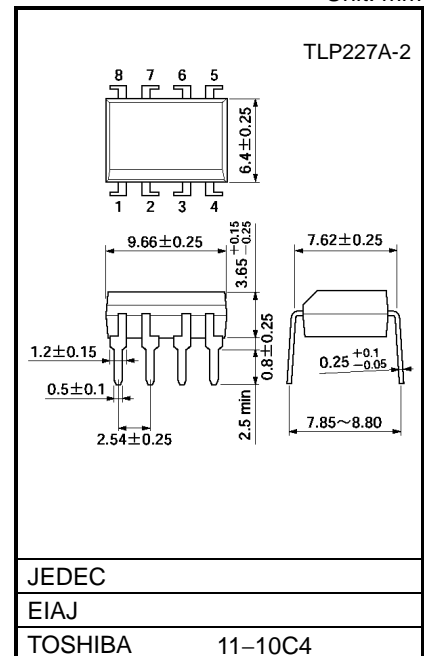

Weight: 0.54 g

MAXIMUM RATINGS (Ta = 25°C)

CHARACTERISTIC			SYMBOL	RATING	UNIT	
LED	Forward Current		I_F	50	mA	
	Forward Current Derating (Ta ≥ 25°C)		$\Delta I_F/^\circ\text{C}$	-0.5	mA/°C	
	Peak Forward Current (100µs pulse, 100 pps)		I_{FP}	1	A	
	Reverse Voltage		V_R	5	V	
	Junction Temperature		T_j	125	°C	
DETECTOR	Off-State Output Terminal Voltage		V_{OFF}	60	V	
	On-State Current	TLP227A	I_{ON}	500	mA	
		TLP227A-2				One Channel
			Both Channel (Note 1)			
	On-State Current Derating (Ta ≥ 25°C)	TLP227A	$\Delta I_{ON}/^\circ\text{C}$	-5.0	mA/°C	
		TLP227A-2				One Channel
		Both Channel (Note 1)				
Junction Temperature		T_j	125	°C		
Storage Temperature Range		T_{stg}	-55~125	°C		
Operating Temperature Range		T_{opr}	-40~85	°C		
Lead Soldering Temperature (10 s)		T_{sol}	260	°C		
Isolation Voltage (AC, 1 minute, R.H. ≤ 60%)		BV_S	2500	Vrms		

(Note 1) :Two channels operating simultaneously.

(Note 2):Device considered a two-terminal device : LED side pins shorted together, and DETECTOR side pins shorted together.

RECOMMENDED OPERATING CONDISIONS

CHARACTERISTIC	SYMBOL	MIN.	TYP.	MAX.	UNIT
Supply Voltage	V_{DD}	—	—	48	V
Forward Current	I_F	5	7.5	25	mA
On-State Current	I_{ON}	—	—	400	mA
Operating Temperature	T_{opr}	-20	—	65	°C

INDIVIDUAL ELECTRICAL CHARACTERISTICS (Ta = 25°C)

CHARACTERISTIC		SYMBOL	TEST CONDITION	MIN.	TYP.	MAX.	UNIT
LED	Forward Voltage	V_F	$I_F = 10 \text{ mA}$	1.0	1.15	1.3	V
	Reverse Current	I_R	$V_R = 5 \text{ V}$	—	—	10	µA
	Capacitance	C_T	$V = 0, f = 1 \text{ MHz}$	—	30	—	pF
DETECTOR	Off-State Current	I_{OFF}	$V_{OFF} = 60 \text{ V}$	—	—	1	µA
	Capacitance	C_{OFF}	$V = 0, f = 1 \text{ MHz}$	—	130	—	pF

COUPLED ELECTRICAL CHARACTERISTICS (Ta = 25°C)

CHARACTERISTIC	SYMBOL	TEST CONDITION	MIN.	TYP.	MAX.	UNIT
Trigger LED Current	I_{FT}	$I_{ON} = 300 \text{ mA}$	—	1	3	mA
Close LED Current	I_{FC}	$I_{OFF} = 100 \mu\text{A}$	0.1	—	—	mA
On-State Resistance	R_{ON}	$I_{ON} = 300 \text{ mA}, I_F = 5 \text{ mA}$	—	1	2	Ω

ISOLATION CHARACTERISTICS (Ta = 25°C)

CHARACTERISTIC	SYMBOL	TEST CONDITION	MIN.	TYP.	MAX.	UNIT
Capacitance Input to Output	C_S	$V_S = 0 \text{ V}, f = 1 \text{ MHz}$	—	0.8	—	pF
Isolation Resistance	R_S	$V_S = 500 \text{ V}, \text{R.H.} \leq 60\%$	5×10^{10}	10^{14}	—	Ω
Isolation Voltage	BV_S	AC, 1 minute	2500	—	—	Vrms
		AC, 1 second (in oil)	—	5000	—	Vrms
		DC, 1 minute (in oil)	—	5000	—	Vdc

SWITCHING CHARACTERISTICS (Ta = 25°C)

CHARACTERISTIC	SYMBOL	TEST CONDITION	MIN.	TYP.	MAX.	UNIT
Turn-on Time	t_{ON}	$R_L = 200 \Omega$ $V_{DD} = 20 \text{ V}, I_F = 5 \text{ mA}$ (Note 3)	—	0.6	2	ms
Turn-off Time	t_{OFF}		—	0.1	1	
Turn-on Time	t_{ON}	$R_L = 200 \Omega$ $V_{DD} = 30 \text{ V}, I_F = 10 \text{ mA}$ (Note 3)	—	0.3	1	ms
Turn-off Time	t_{OFF}		—	0.1	1	

(Note 3) : SWITCHING TIME TEST CIRCUIT

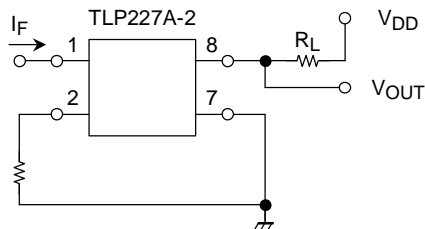
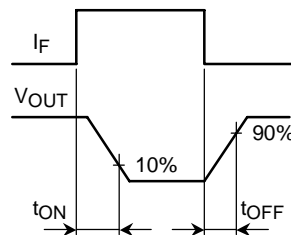
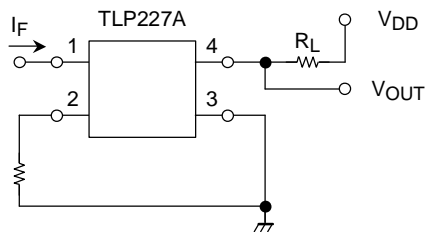

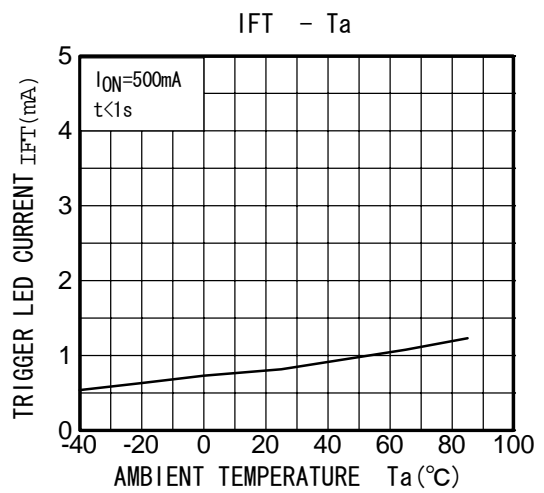
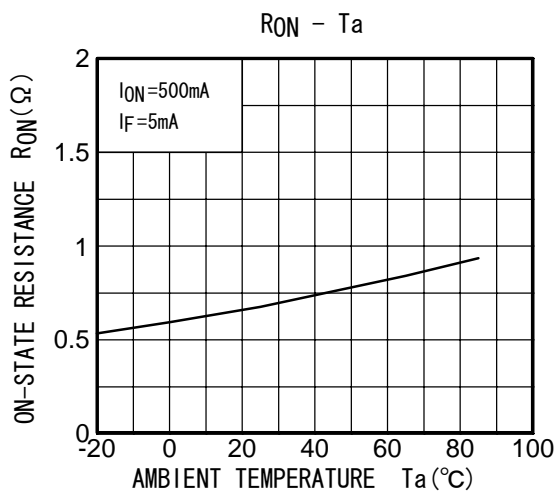
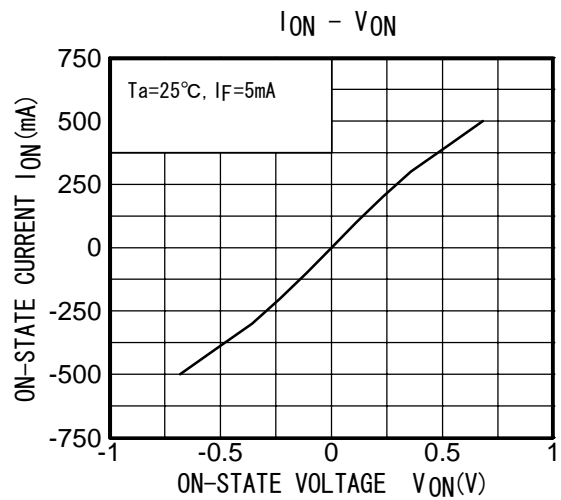
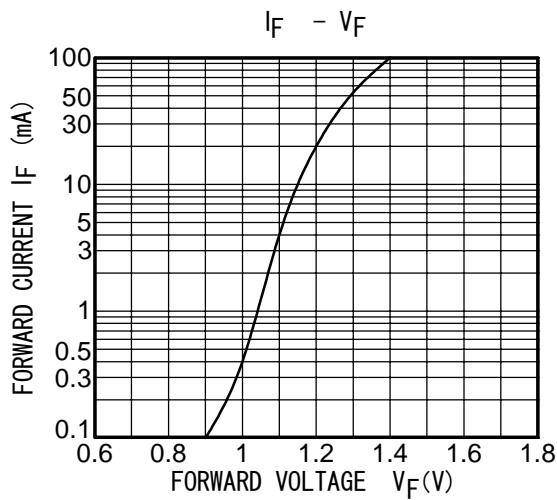
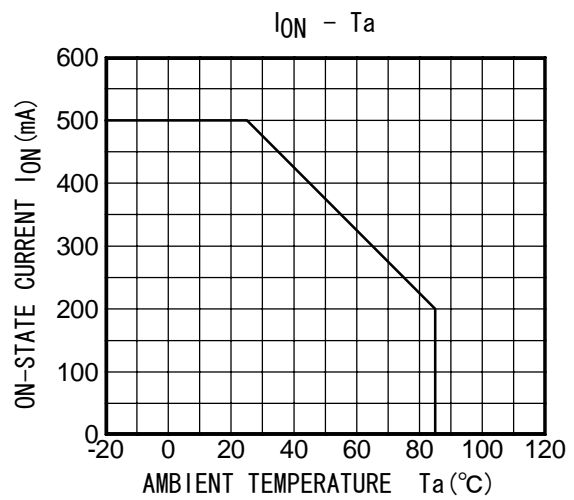
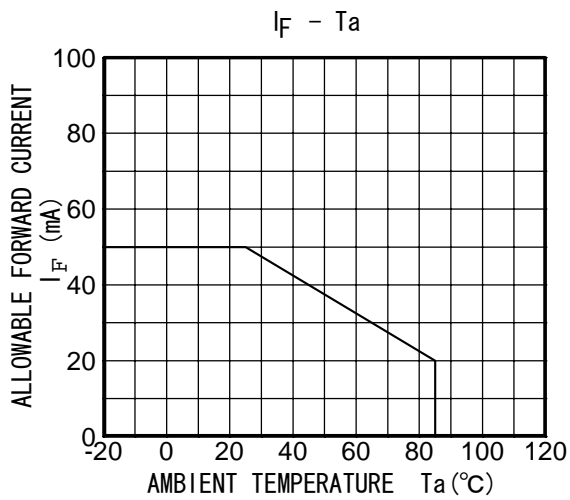

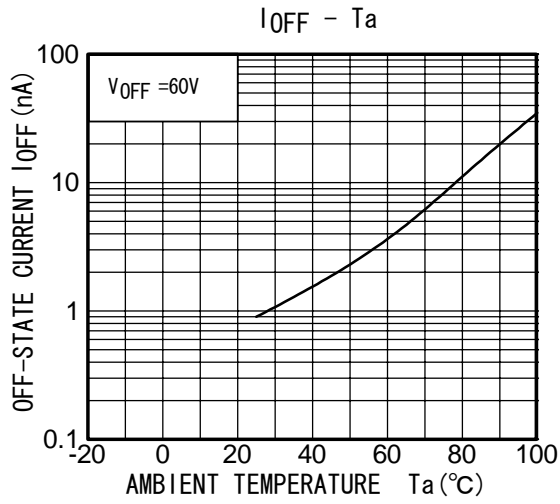
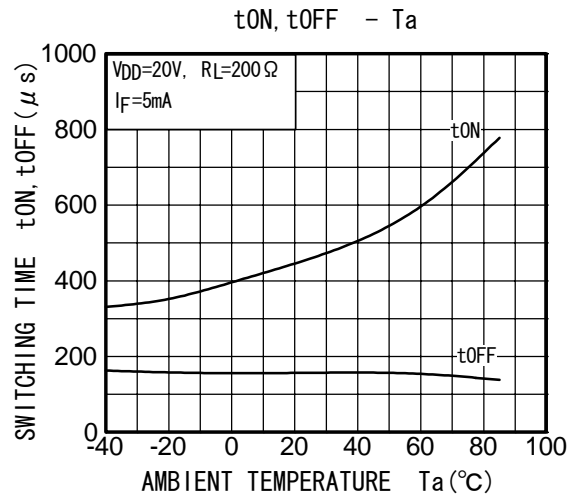
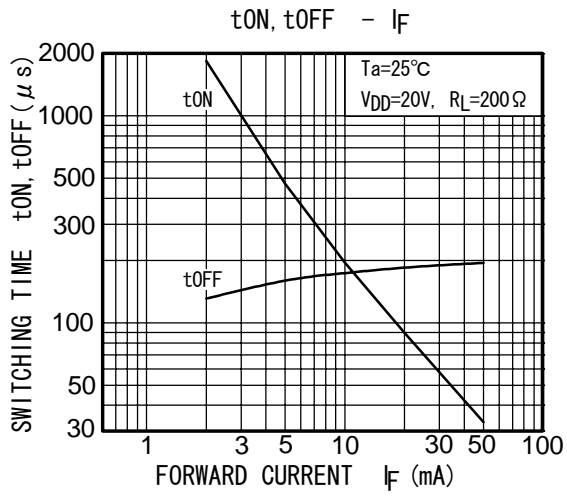

RESTRICTIONS ON PRODUCT USE

000707EBC

- TOSHIBA is continually working to improve the quality and reliability of its products. Nevertheless, semiconductor devices in general can malfunction or fail due to their inherent electrical sensitivity and vulnerability to physical stress. It is the responsibility of the buyer, when utilizing TOSHIBA products, to comply with the standards of safety in making a safe design for the entire system, and to avoid situations in which a malfunction or failure of such TOSHIBA products could cause loss of human life, bodily injury or damage to property.
In developing your designs, please ensure that TOSHIBA products are used within specified operating ranges as set forth in the most recent TOSHIBA products specifications. Also, please keep in mind the precautions and conditions set forth in the "Handling Guide for Semiconductor Devices," or "TOSHIBA Semiconductor Reliability Handbook" etc..
- The TOSHIBA products listed in this document are intended for usage in general electronics applications (computer, personal equipment, office equipment, measuring equipment, industrial robotics, domestic appliances, etc.). These TOSHIBA products are neither intended nor warranted for usage in equipment that requires extraordinarily high quality and/or reliability or a malfunction or failure of which may cause loss of human life or bodily injury ("Unintended Usage"). Unintended Usage include atomic energy control instruments, airplane or spaceship instruments, transportation instruments, traffic signal instruments, combustion control instruments, medical instruments, all types of safety devices, etc.. Unintended Usage of TOSHIBA products listed in this document shall be made at the customer's own risk.
- Gallium arsenide (GaAs) is a substance used in the products described in this document. GaAs dust and fumes are toxic. Do not break, cut or pulverize the product, or use chemicals to dissolve them. When disposing of the products, follow the appropriate regulations. Do not dispose of the products with other industrial waste or with domestic garbage.
- The products described in this document are subject to the foreign exchange and foreign trade laws.
- The information contained herein is presented only as a guide for the applications of our products. No responsibility is assumed by TOSHIBA CORPORATION for any infringements of intellectual property or other rights of the third parties which may result from its use. No license is granted by implication or otherwise under any intellectual property or other rights of TOSHIBA CORPORATION or others.
- The information contained herein is subject to change without notice.