

TC55257BPL/BFL/BSPL/BFTL/BTRL-85L/10L(LV)

SILICON GATE CMOS

32,768 WORD x 8 BIT STATIC RAM

Description

The TC55257BPL is a 262,144 bit CMOS static random access memory organized as 32,768 words by 8 bits and operated from a single 5V power supply. Advanced circuit techniques provide both high speed and low power features with an operating current of 5mA/MHz (typ.) and a minimum cycle time of 85ns.

When \overline{CE} is a logical high, the device is placed in a low power standby mode in which the standby current is 2 μ A at room temperature. The TC55257BPL has two control inputs. Chip enable (\overline{CE}) allows for device selection and data retention control, while an output enable input (\overline{OE}) provides fast memory access. The TC55257BPL is suitable for use in microprocessor systems where high speed, low power, and battery backup are required.

The TC55257BPL is offered in a standard dual-in-line 28-pin plastic package (0.6/0.3 inch width), a small outline plastic package, and a thin small outline plastic package (forward type, reverse type).

Features

- Low power dissipation: 27.5mW/MHz (typ.)
- Standby current: 2 μ A (max.) at Ta = 25°C
- Single 5V power supply
- Access time (max.)

	TC55257BPL/BFL/BSPL/BFTL/BTRL	
	-85L(LV)	-10L(LV)
Access Time	85ns	100ns
Chip Enable Access Time	85ns	100ns
Output Enable Time	45ns	50ns

- Power down feature: \overline{CE}
- Data retention supply voltage: 2.0 ~ 5.5V
- Inputs and outputs TTL compatible
- Package
 - TC55257BPL : DIP28-P-600
 - TC55257BFL : SOP28-P-450
 - TC55257BSPL : DIP28-P-300B
 - TC55257BFTL : TSOP28-P
 - TC55257BTRL : TSOP28-P-A

Pin Names

A0 ~ A14	Address Inputs
R/W	Read/Write Control Input
\overline{OE}	Output Enable Input
\overline{CE}	Chip Enable Input
I/O1 ~ I/O8	Data Input/Output
V _{DD}	Power (+5V)
GND	Ground

Pin Connection (Top View)

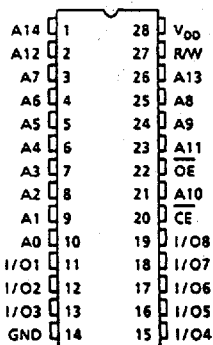

(forward type)

(reverse type)

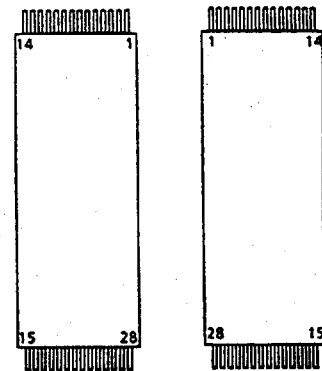

PIN NO.	1	2	3	4	5	6	7	8	9	10	11	12	13	14
PIN NAME	\overline{OE}	A ₁₁	A ₉	A ₈	A ₁₃	R/W	V _{DD}	A ₁₄	A ₁₂	A ₇	A ₆	A ₅	A ₄	A ₃
PIN NO.	15	16	17	18	19	20	21	22	23	24	25	26	27	28
PIN NAME	A ₂	A ₁	A ₀	I/O1	I/O2	I/O3	GND	I/O4	I/O5	I/O6	I/O7	I/O8	\overline{CE}	A ₁₀

Block Diagram

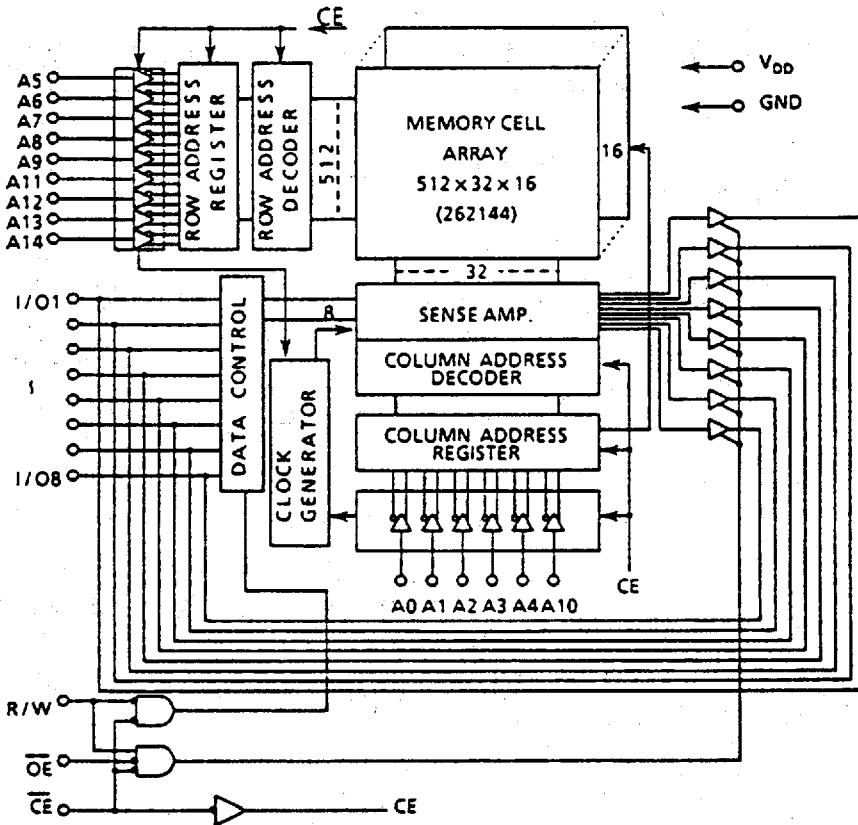

Operating Mode

MODE	PIN	\overline{CE}	\overline{OE}	R/W	I/O1 ~ I/O8	POWER
Read		L	L	H	D _{OUT}	I _{DDO}
Write		L	*	L	D _{IN}	I _{DDO}
Output Deselect		L	H	H	High-Z	I _{DDO}
Standby		H	*	*	High-Z	I _{DDs}

* H or L

Maximum Ratings

SYMBOL	ITEM	RATING	UNIT
V _{DD}	Power Supply Voltage	-0.3 ~ 7.0	V
V _{IN}	Input Voltage	-0.3* ~ 7.0	V
V _{I/O}	Input and Output Voltage	-0.5* ~ V _{DD} + 0.5	V
P _D	Power Dissipation	1.0/0.8/0.6**	W
T _{SOLDER}	Soldering Temperature • Time	260 • 10	°C • sec
T _{STRG}	Storage Temperature	-55 ~ 150	°C
T _{OPR}	Operating Temperature	0 ~ 70	°C

* -3.0V with a pulse width of 50ns

** Package dependent: 0.6 inch 1.0W, 0.3 inch 0.8W, 0.45 inch 0.6W

A-34

TOSHIBA AMERICA ELECTRONIC COMPONENTS, INC.

DC Recommended Operating Conditions

SYMBOL	PARAMETER	MIN.	TYP.	MAX.	UNIT
V_{DD}	Power Supply Voltage	4.5	5.0	5.5	V
V_{IH}	Input High Voltage	2.2	-	$V_{DD} + 0.3$	
V_{IL}	Input Low Voltage	-0.3*	-	0.8	
V_{DH}	Data Retention Supply Voltage	2.0	-	5.5	

* -3.0V with a pulse width of 50ns

DC Characteristics (Ta = 0 ~ 70°C, V_{DD} = 5V±10%)

SYMBOL	PARAMETER	TEST CONDITION	MIN.	TYP.	MAX.	UNIT	
I_{LI}	Input Leakage Current	$V_{IN} = 0 \sim V_{DD}$	-	-	±1.0	μA	
I_{LO}	Output Leakage Current	$\overline{CE} = V_{IH}$ or $R/W = V_{IL}$ or $\overline{OE} = V_{IH}$ $V_{OUT} = 0 \sim V_{DD}$	-	-	±1.0	μA	
I_{OH}	Output High Current	$V_{OH} = 2.4V$	-1.0	-	-	mA	
I_{OL}	Output Low Current	$V_{OL} = 0.4V$	4.0	-	-	mA	
I_{DDO1}	Operating Current	$\overline{CE} = V_{IL}$ $R/W = V_{IH}$ Other Input = V_{IH}/V_{IL} $I_{OUT} = 0mA$	$t_{cycle} = 1\mu s$	-	10	-	mA
			$t_{cycle} = \text{Min. cycle}$	-	-	70	
I_{DDO2}	Operating Current	$\overline{CE} = 0.2V$ $R/W = V_{DD} - 0.2V$ Other Input = $V_{DD} - 0.2V/0.2V$ $I_{OUT} = 0mA$	$t_{cycle} = 1\mu s$	-	5	-	mA
			$t_{cycle} = \text{Min. cycle}$	-	-	60	
I_{DDS1}	Standby Current	$\overline{CE} = V_{IH}$	-	-	3	mA	
I_{DDS2}		$\overline{CE} = V_{DD} - 0.2V$ $V_{DD} = 2.0V \sim 5.5V$	$T_a = 0 \sim 70^\circ C$	-	-	30	μA
		$T_a = 25^\circ C$	-	-	2		

Capacitance* (Ta = 25°C, f = 1MHz)

SYMBOL	PARAMETER	TEST CONDITION	MAX.	UNIT
C_{IN}	Input Capacitance	$V_{IN} = GND$	10	pF
C_{OUT}	Output Capacitance	$V_{OUT} = GND$	10	

*This parameter is periodically sampled and is not 100% tested.

AC Characteristics (Ta = 0 ~ 70°C, V_{DD} = 5V±10%)

Read Cycle

SYMBOL	PARAMETER	TC55257BPL/BFL/BSPL/BFTL/BTRL				UNIT
		-85L(LV)		-10L(LV)		
		MIN.	MAX.	MIN.	MAX.	
t _{RC}	Read Cycle Time	85	—	100	—	ns
t _{ACC}	Address Access Time	—	85	—	100	
t _{CO}	\overline{CE} Access Time	—	85	—	100	
t _{OE}	Output Enable to Output in Valid	—	45	—	50	
t _{COE}	Chip Enable (\overline{CE}) to Output in Low-Z	10	—	10	—	
t _{OEE}	Output Enable to Output in Low-Z	5	—	5	—	
t _{OD}	Chip Enable (\overline{CE}) to Output in High-Z	—	30	—	50	
t _{ODO}	Output Enable to Output in High-Z	—	30	—	40	
t _{OH}	Output Data Hold Time	10	—	10	—	

Write Cycle

SYMBOL	PARAMETER	TC55257BPL/BFL/BSPL/BFTL/BTRL				UNIT
		-85L(LV)		-10L(LV)		
		MIN.	MAX.	MIN.	MAX.	
t _{WC}	Write Cycle Time	85	—	100	—	ns
t _{WP}	Write Pulse Width	60	—	70	—	
t _{CW}	Chip Selection to End of Write	65	—	90	—	
t _{AS}	Address Setup Time	0	—	0	—	
t _{WR}	Write Recovery Time	5	—	5	—	
t _{ODW}	R/W to Output in High-Z	—	30	—	50	
t _{OEW}	R/W to Output in Low-Z	5	—	5	—	
t _{DS}	Data Setup Time	40	—	40	—	
t _{DH}	Data Hold Time	0	—	0	—	

AC Test Conditions

Input Pulse Levels	2.4V/0.6V
Input Pulse Rise and Fall Time	5ns
Input Timing Measurement Reference Levels	2.2V/0.8V
Output Timing Measurement Reference Levels	2.2V/0.8V
Output Load	1 TTL Gate and C _L = 100pF

Timing Waveforms

Read Cycle ⁽¹⁾

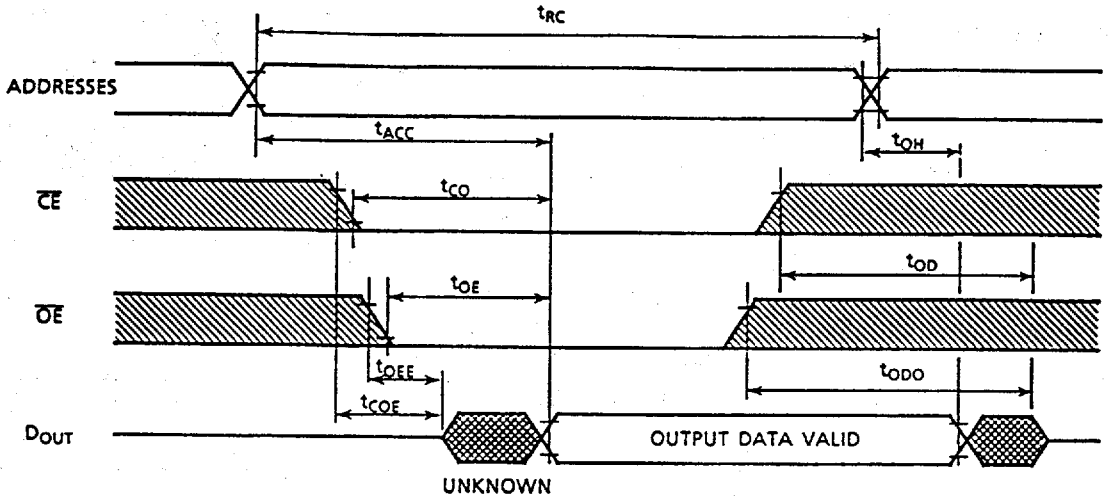

Write Cycle 1 ⁽⁴⁾ (R/W Controlled Write)

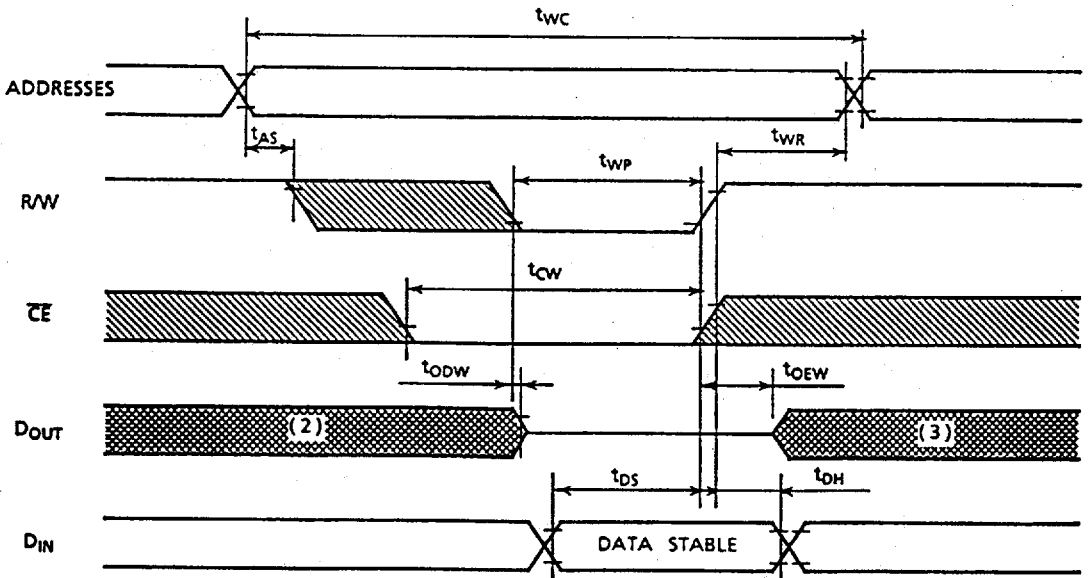

Write Cycle 2 ⁽⁴⁾ (\overline{CE} Controlled Write)

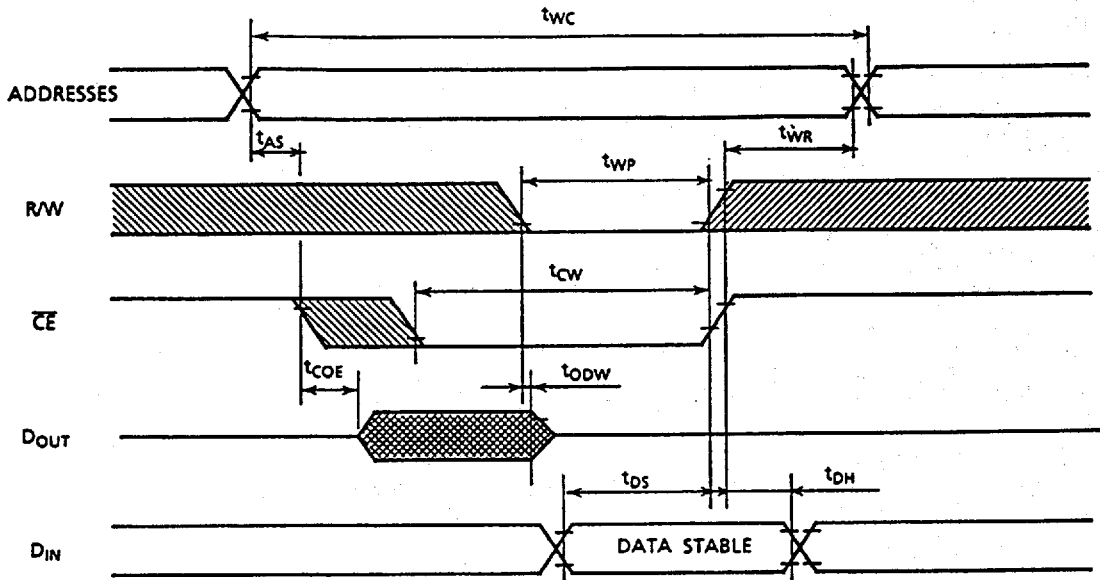

Notes:

1. R/W is high for read cycles.
2. If the \overline{CE} low transition occurs coincident with or after the R/W low transition, outputs remain in a high impedance state.
3. If the \overline{CE} high transition occurs coincident with or prior to the R/W high transition, outputs remain in a high impedance state.
4. If \overline{OE} is high during a write cycle, the outputs are in a high impedance state during this period.

Data Retention Characteristics (Ta = 0 ~ 70°C)

SYMBOL	PARAMETER	MIN.	TYP.	MAX.	UNIT
V _{DH}	Data Retention Supply Voltage	2.0	-	5.5	V
I _{DDS2}	Standby Current	V _{DH} = 3.0V	-	20	μA
		V _{DH} = 5.5V	-	30	
t _{CDR}	Chip Deselect to Data Retention Mode	0	-	-	μs
t _R	Recovery Time	t _{RC(1)}	-	-	

Note (1): Read Cycle Time

\overline{CE} Controlled Data Retention Mode

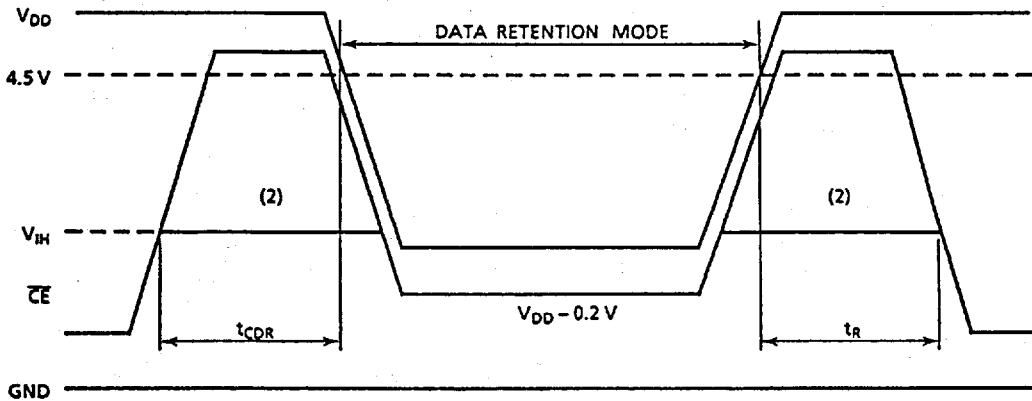

Note (2): If the V_{IH} of \overline{CE} is 2.2V in operation, I_{DDs1} current flows during the period that the V_{DD} voltage is going down from 4.5V to 2.4V.

3V Operation

DC Recommended Operating Conditions

SYMBOL	PARAMETER	MIN.	TYP.	MAX.	UNIT
V _{DD}	Power Supply Voltage	2.7	3.0	3.3	V
V _{IH}	Input High Voltage	V _{DD} - 0.2	-	V _{DD} + 0.3	
V _{IL}	Input Low Voltage	-0.3	-	0.2	

DC Characteristics (Ta = 0 ~ 70°C, V_{DD} = 3V±10%)

SYMBOL	PARAMETER	TEST CONDITION	MIN.	TYP.	MAX.	UNIT		
I _{LI}	Input Leakage Current	V _{IN} = 0 ~ V _{DD}	-	-	±1.0	μA		
I _{LO}	Output Leakage Current	$\overline{CE} = V_{IH}$ or R/W = V _{IL} or $\overline{OE} = V_{IH}$, V _{OUT} = 0 ~ V _{DD}	-	-	±1.0	μA		
I _{OH}	Output High Current	V _{OH} = V _{DD} - 0.2V	-0.1	-	-	mA		
I _{OL}	Output Low Current	V _{OL} = 0.2V	0.1	-	-	mA		
I _{DDO2}	Operating Current	$\overline{CE} = 0.2V$ R/W = V _{DD} - 0.2V I _{OUT} = 0mA Other Inputs = V _{DD} - 0.2V/0.2V	t _{cycle}	Min.	-	-	20	mA
				1μs	-	-	5	
I _{DD2}	Standby Current	$\overline{CE} = V_{DD} - 0.2V$	Ta = 0 ~ 70°C	-	-	20	μA	
			Ta = 25°C	-	1	2		

Capacitance* (Ta = 25°C, f = 1MHz)

SYMBOL	PARAMETER	TEST CONDITION	MAX.	UNIT
C _{IN}	Input Capacitance	V _{IN} = GND	10	pF
C _{OUT}	Output Capacitance	V _{OUT} = GND	10	

*This parameter is periodically sampled and is not 100% tested.

3V OperationDC Characteristics ($T_a = 0 \sim 70^\circ\text{C}$, $V_{DD} = 3V \pm 10\%$)**Read Cycle**

SYMBOL	PARAMETER	MIN.	MAX.	UNIT
t_{RC}	Read Cycle Time	200	—	ns
t_{ACC}	Address Access Time	—	200	
t_{CO}	\overline{CE} Access Time	—	200	
t_{OE}	Output Enable to Output in Valid	—	100	
t_{COE}	Chip Enable (\overline{CE}) to Output in Low-Z	10	—	
t_{OEE}	Output Enable to Output in Low-Z	5	—	
t_{OD}	Chip Enable (\overline{CE}) to Output in High-Z	—	100	
t_{ODO}	Output Enable to Output in High-Z	—	80	
t_{OH}	Output Data Hold Time	10	—	

Write Cycle

SYMBOL	PARAMETER	MIN.	MAX.	UNIT
t_{WC}	Write Cycle Time	200	—	ns
t_{WP}	Write Pulse Width	150	—	
t_{CW}	Chip Selection to End of Write	180	—	
t_{AS}	Address Setup Time	0	—	
t_{WR}	Write Recovery Time	5	—	
t_{ODW}	R/W to Output in High-Z	—	100	
t_{OEW}	R/W to Output in Low-Z	5	—	
t_{DS}	Data Setup Time	90	—	
t_{DH}	Data Hold Time	0	—	

AC Test Conditions

Input Pulse Levels	$V_{DD} - 0.2V/0.2V$
Input Pulse Rise and Fall Time	5ns
Input Timing Measurement Reference Levels	1.5V
Output Timing Measurement Reference Levels	1.5V
Output Load	$C_L = 100\text{pF}$