

**RF Driver Amplifier  
250 - 4000 MHz**

**MAAMSS0049  
V1**

**Features**

- Output Intercept Point of +40 dBm over a 20 dB Input Power Range
- Broadband Operation
- Excellent ACPR performance
- Lead-Free SOT-89 Package
- 100% Matte Tin Plating over Copper
- Halogen-Free “Green” Mold Compound
- RoHS\* Compliant and 260°C Reflow Compatible

**Description**

M/A-COM’s MAAMSS0049 RF driver amplifier is a GaAs MMIC which exhibits exceptional linearity performance over a >20 dB dynamic range, as well as featuring high gain in a lead-free miniature SOT-89 surface mount plastic package. The device runs off a single +5 volt supply and draws 230 mA typically.

The MAAMSS0049 is fabricated using an HBT process to realize low current and high linearity. The process features full passivation for increased performance and reliability.

**Functional Schematic**

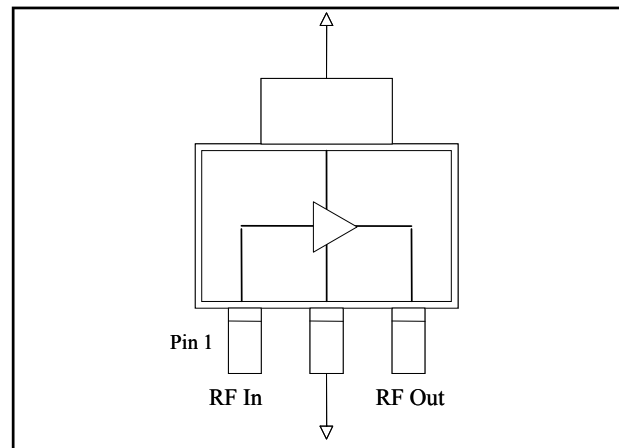

**Pin Configuration**

Pin No.	Function	Pin No.	Function
1	RF Input	3	RF Output/ Bias
2	Ground		

**Ordering Information <sup>1</sup>**

Part Number	Package
MAAMSS0049	Bulk Packaging
MAAMSS0049SMB-01	900 MHz Configuration
MAAMSS0049SMB-02	1900 MHz Configuration
MAAMSS0049SMB-03	2140 MHz Configuration
MAAMSS0049TR-3000	3000 piece reel

1. Reference Application Note M513 for reel size information.

**Maximum Operating Conditions <sup>2</sup>**

Parameter	Maximum Operating Conditions
Junction Temperature	160°C
RF Output Power	28 dBm

2. Operating at, or below this condition, at or below 85°C will give a MTTF > 1 x 10<sup>6</sup> hours.

**Absolute Maximum Ratings <sup>3,4</sup>**

Parameter	Absolute Maximum
RF Output Power	29 dBm
Voltage	6 volts
Operating Temperature	-40 °C to +85 °C
Storage Temperature	-65 °C to +150 °C
Junction Temperature <sup>5</sup>	200°C

3. Exceeding any one or combination of these limits may cause permanent damage to this device.
4. M/A-COM does not recommend sustained operation near these survivability limits.
5. Typical thermal resistance (θ<sub>jc</sub>) = 55°C/W.

\* Restrictions on Hazardous Substances, European Union Directive 2002/95/EC.

**RF Driver Amplifier  
250 - 4000 MHz**

**MAAMSS0049  
V1**

**Electrical Specifications:  $T_A = 25^\circ\text{C}$ ,  $V_{CC} = 5\text{ V}$ ,  $Z_0 = 50\ \Omega$**

Parameter	Test Conditions	Units	Min.	Typ.	Max.
Gain	900 MHz	dB	—	19.0	—
	1900 MHz	dB	—	15.5	—
	2140 MHz	dB	14	15.5	—
Input Return Loss	900 MHz	dB	—	-15	—
	1900 MHz	dB	—	-11	—
	2140 MHz	dB	—	-20	—
Output Return Loss	900 MHz	dB	—	-15	—
	1900 MHz	dB	—	-10	—
	2140 MHz	dB	—	-15	—
Output P1dB	900 MHz	dBm	—	28.5	—
	1900 MHz	dBm	—	28.5	—
	2140 MHz	dBm	—	28.5	—
Output IP3	(+20 dBm / tone, 1 MHz spacing) 900 MHz	dBm	—	43	—
	1900 MHz	dBm	—	43	—
	2140 MHz	dBm	38	43	—
Channel Power	(@ -45 dBc ACPR, IS-95 9 channels fwd) 900 MHz	dBm	—	22	—
	1900 MHz	dBm	—	20	—
	2140 MHz	dBm	—	19	—
Noise Figure	900 MHz	dB	—	3.5	—
	1900 MHz	dB	—	3.5	—
	2140 MHz	dB	—	3.5	—
Device / Supply Voltage	900 MHz	V	—	5	—
	1900 MHz	V	—	5	—
	2140 MHz	V	—	5	—
Quiescent Current		mA	—	230	—
Current @ 20 dBm Output	2140 MHz	mA	—	288	325

**Lead-Free SOT-89 Plastic Package<sup>†</sup>**

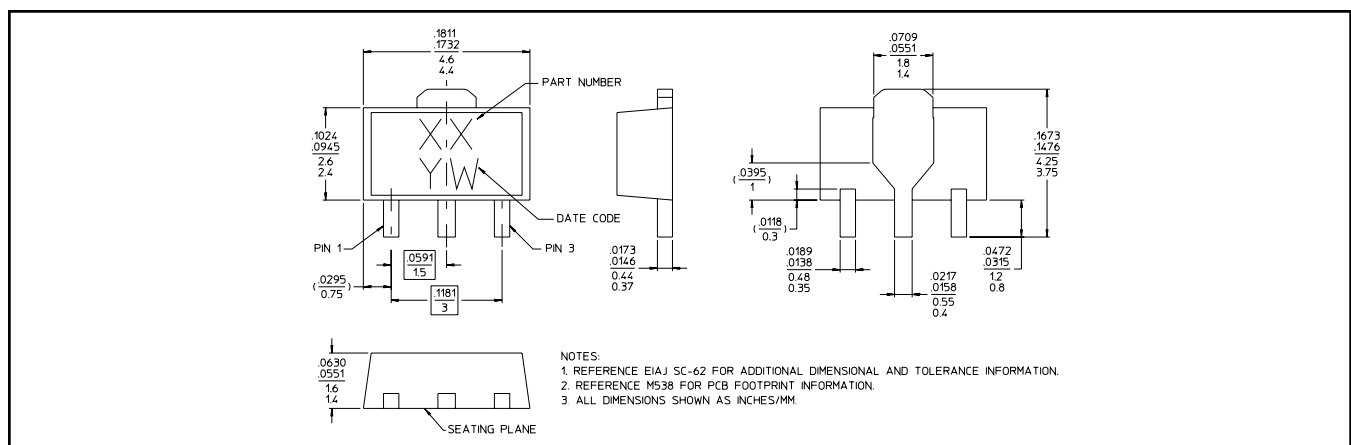

<sup>†</sup> Reference Application Note M538 for lead-free solder reflow recommendations.

**RF Driver Amplifier  
250 - 4000 MHz**

**MAAMSS0049  
V1**

**900 MHz PCB Layout**

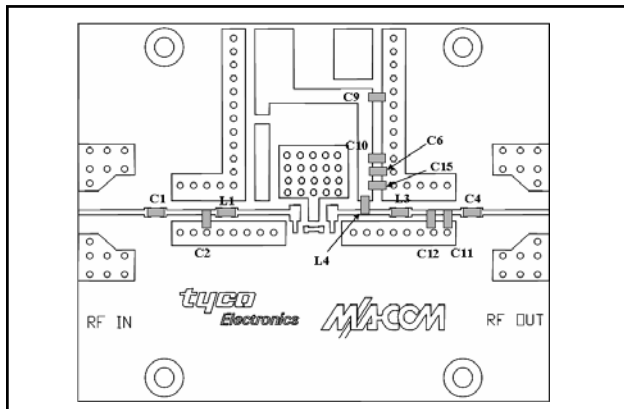

**900 MHz Schematic**

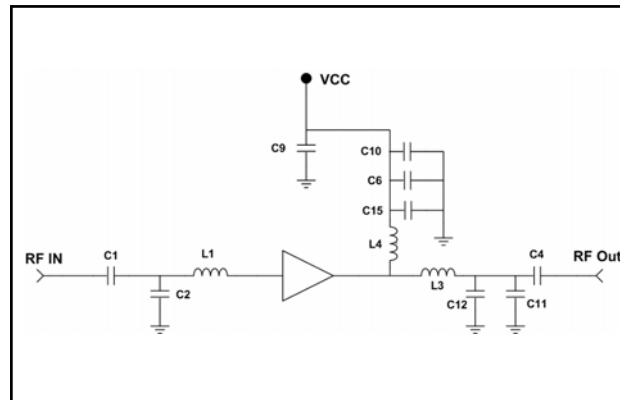

**1900 MHz PCB Layout**

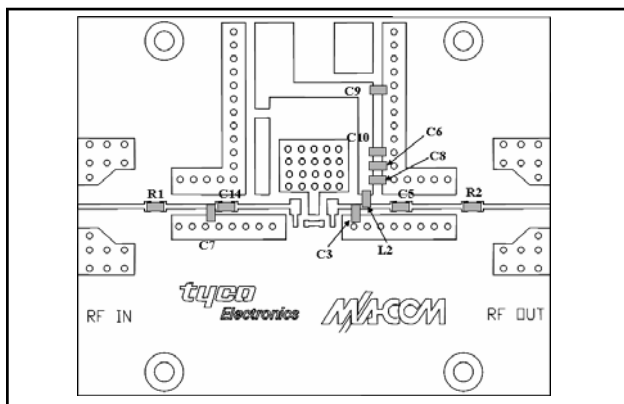

**1900 MHz Schematic**

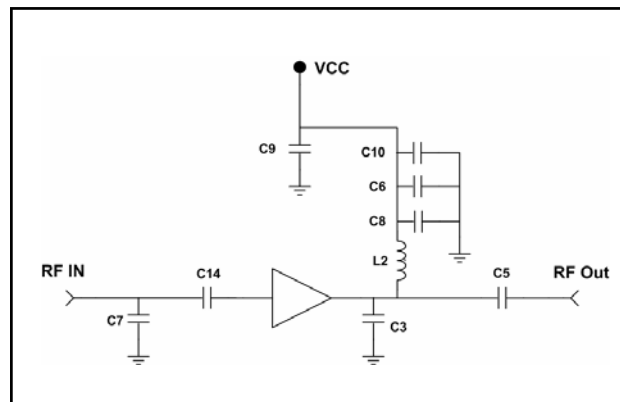

**2140 MHz PCB Layout**

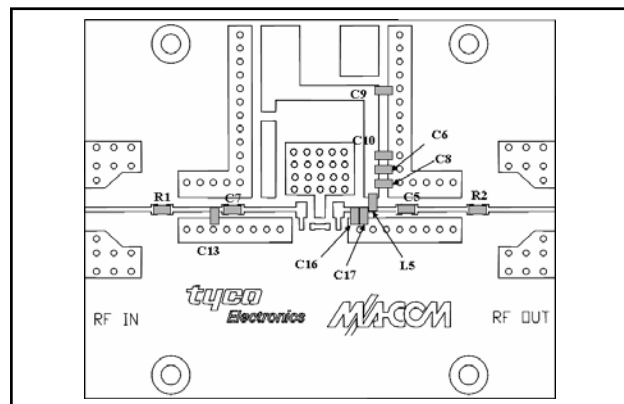

**2140 Schematic**

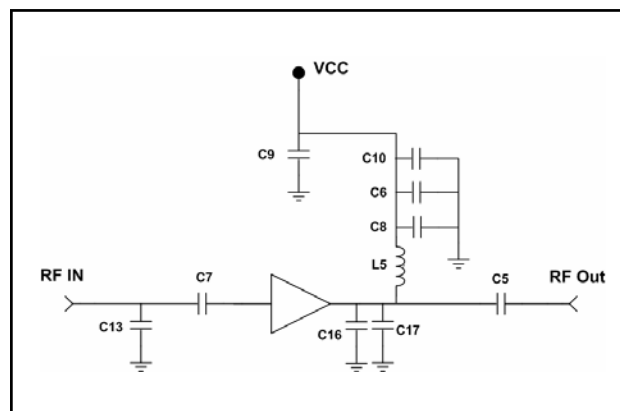

**Parts List**

Part	Value	Used on Freq. Band	Case Style	Manufacturer	Purpose
C1, C4	1000 pF	300, 900	0402	Murata	DC Block
C6	1000 pF	All	0402	Murata	Bypass
C2	6.8 pF	900	0402	Murata	Input Tuning
C3	3.3 pF	1900	0402	Murata	Output Tuning
C5	39 pF	1900, 2140	0402	Murata	DC Block
C7	2.7 pF	1900, 2140	0402	Murata	Input Tuning & DC Block
C8	15 pF	300, 1900, 2140, 2400, 3500	0402	Murata	Bypass
C9, C10	0.1 uF	All	0402	Murata	Bypass
C11	4.7 pF	900	0402	Murata	Output Tuning
C12	1.2 pF	900	0402	Murata	Output Tuning
C13	2.2 pF	1900	0402	Murata	Input Tuning
C16, C21	2.2 pF	2140, 2400	0402	Murata	Output Tuning
C14	5 pF	1900	0402	Murata	Output Tuning & DC Block
C15	100 pF	900	0402	Murata	Bypass
C17, C20, C23	1 pF	2140, 2400, 3500	0402	Murata	Input Tuning & Output Tuning
L1, L8	2.2 nH	900, 2400	0402	Coilcraft	Input Tuning
L2	5.6 nH	1900	0402	Coilcraft	Bias Injection
L3	1 nH	900	0402	Coilcraft	Output Tuning
L4	15 nH	900	0402	Coilcraft	Bias Injection
L5	3.6 nH	2140	0402	Coilcraft	Bias Injection
R1, R2	0 Ohms	1900, 2140	0402	Panasonic	Jumper
C18, C19	18 pF	300	0402	Murata	Input Tuning & Output Tuning
C22	0.5 pF	2400, 3500	0402	Murata	Input Tuning & Output Tuning
L6	23 nH	300	0402	Panasonic	Input Tuning
L7	8.2 nH	300	0402	Coilcraft	Output Tuning

**Cross Section View**

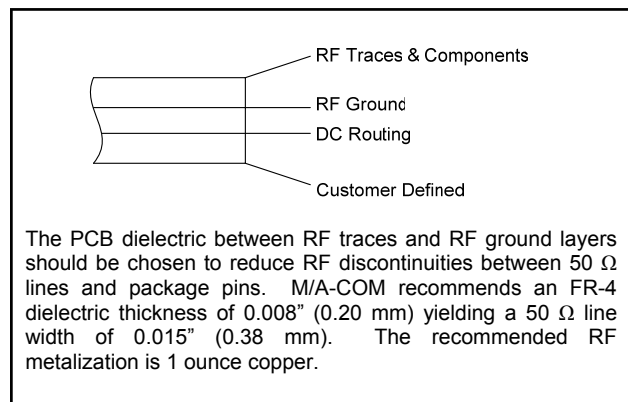

**Handling Procedures**

Please observe the following precautions to avoid damage:

**Static Sensitivity**

Gallium Arsenide Integrated Circuits are sensitive to electrostatic discharge (ESD) and can be damaged by static electricity. Proper ESD control techniques should be used when handling these devices.

- **North America** Tel: 800.366.2266 / Fax: 978.366.2266
- **Europe** Tel: 44.1908.574.200 / Fax: 44.1908.574.300
- **Asia/Pacific** Tel: 81.44.844.8296 / Fax: 81.44.844.8298

Visit [www.macom.com](http://www.macom.com) for additional data sheets and product information.

**Typical Performance Curves, 900 MHz Configuration,  $V_{CC} = +5 V$**

**Gain**

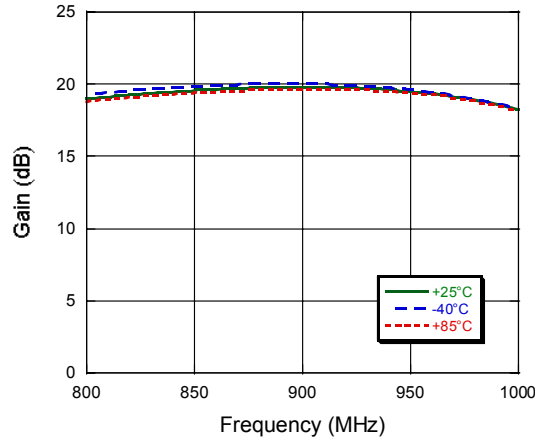

**Noise Figure**

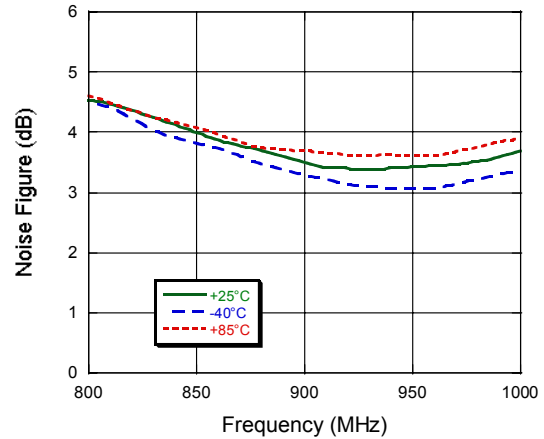

**Input Return Loss**

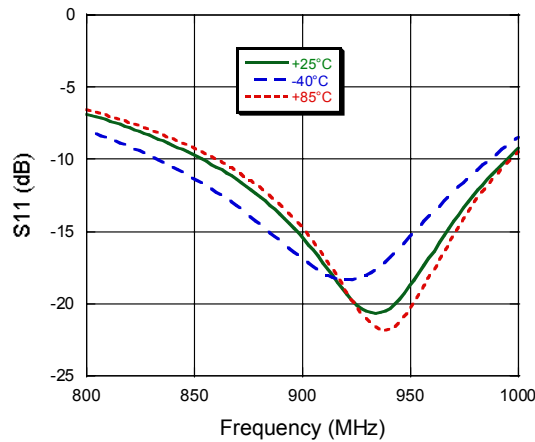

**Output Return Loss**

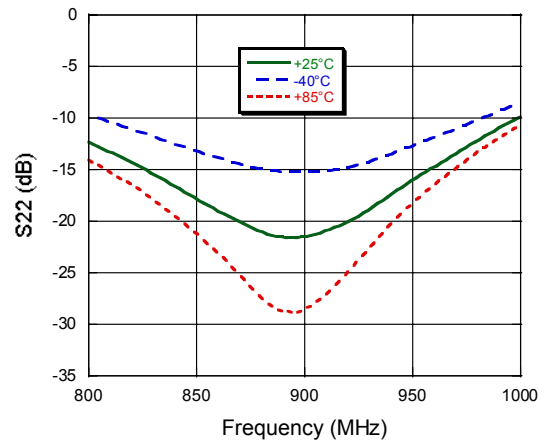

**P1dB**

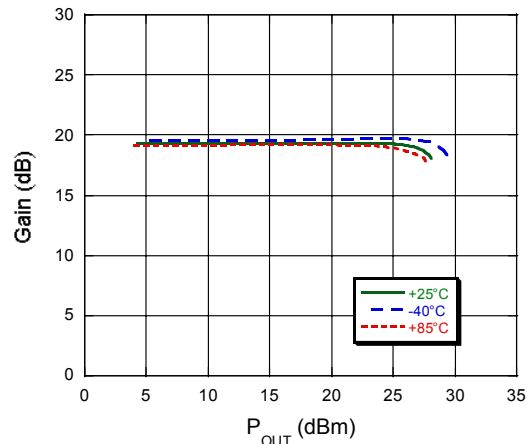

**Output IP3**

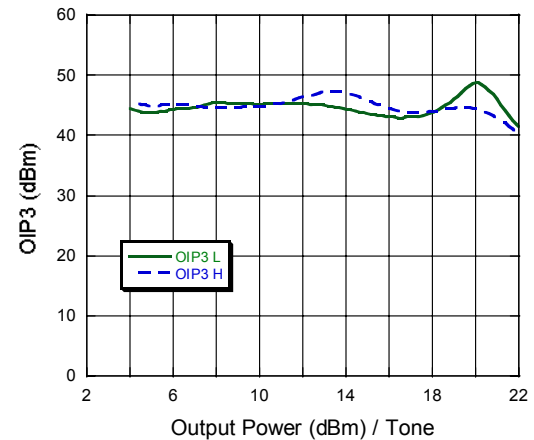

**Typical Performance Curves, 1900 MHz Configuration**

**Gain**

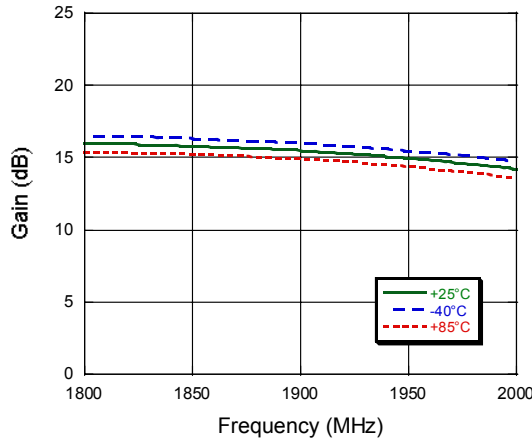

**Noise Figure**

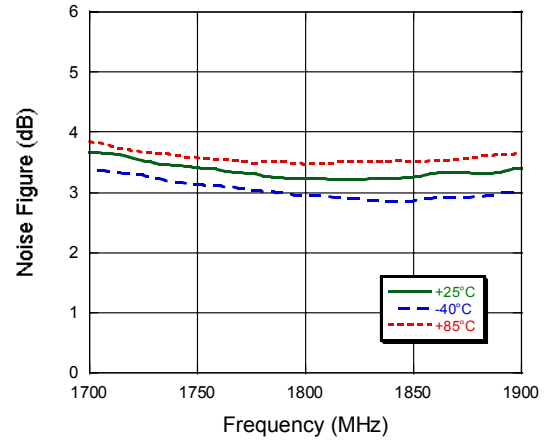

**Input Return Loss**

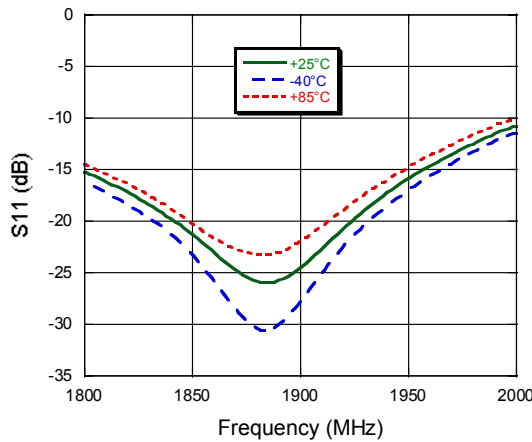

**Output Return Loss**

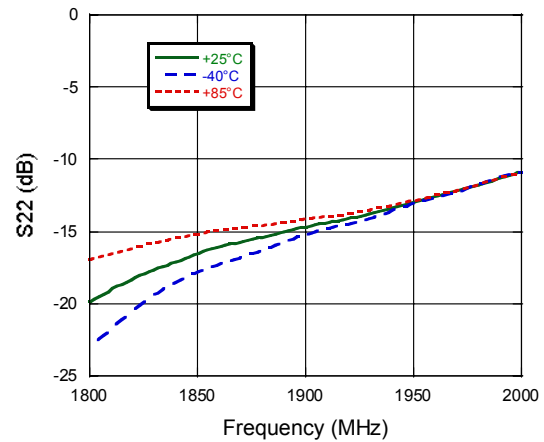

**P1dB**

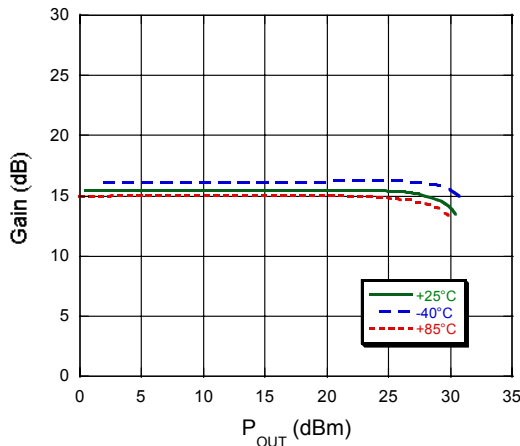

**Output IP3**

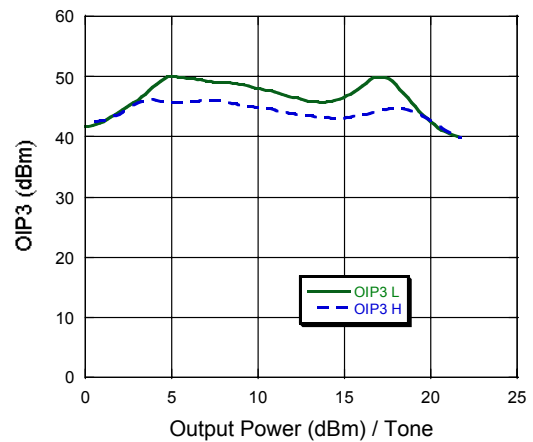

**Typical Performance Curves, 2140 MHz Configuration**

**Gain**

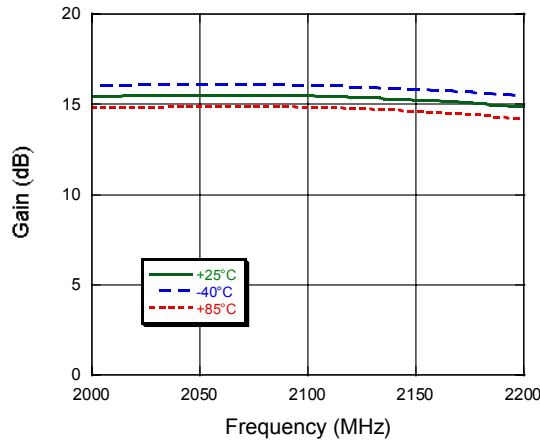

**Noise Figure**

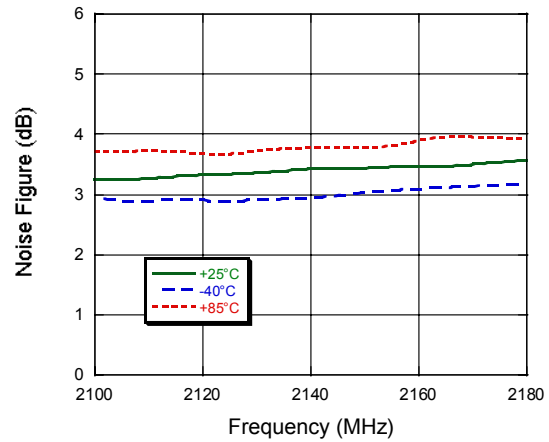

**Input Return Loss**

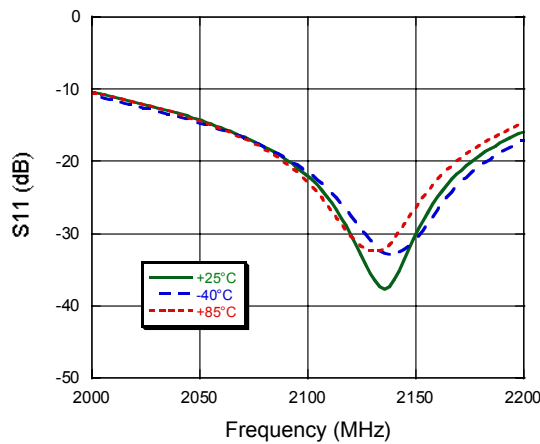

**Output Return Loss**

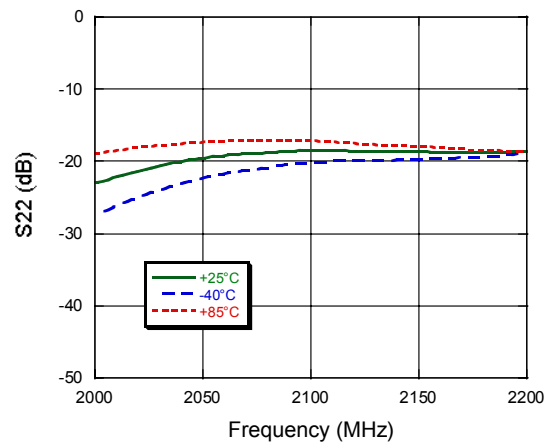

**P1dB**

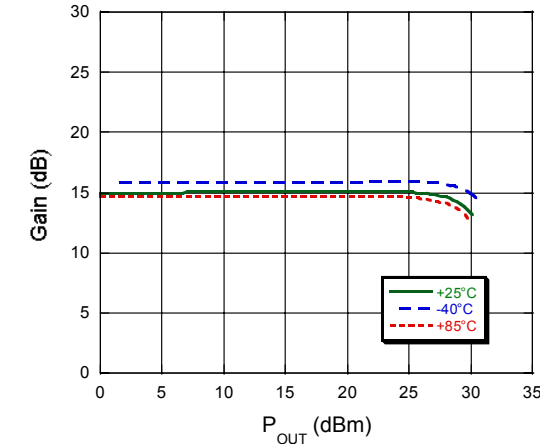

**Output IP3**

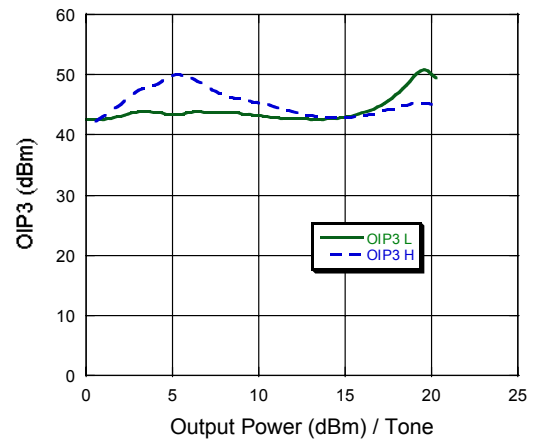

**Applications Section**

**Typical Performance Curves, 300 MHz Configuration**

**Gain**

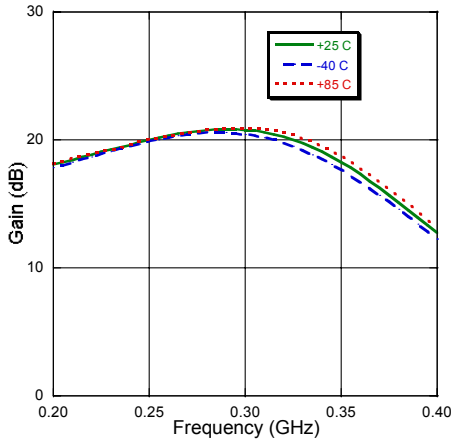

**Input Return Loss**

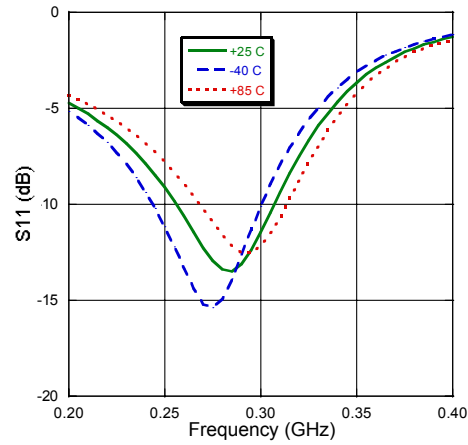

**Output Return Loss**

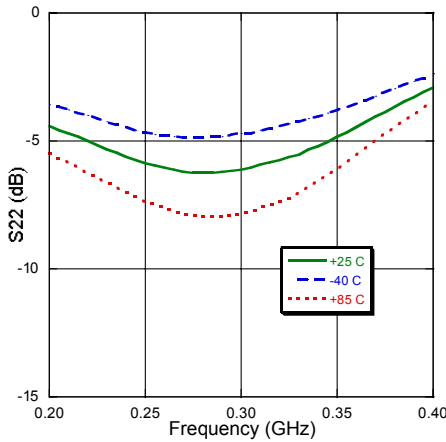

**Output IP3**

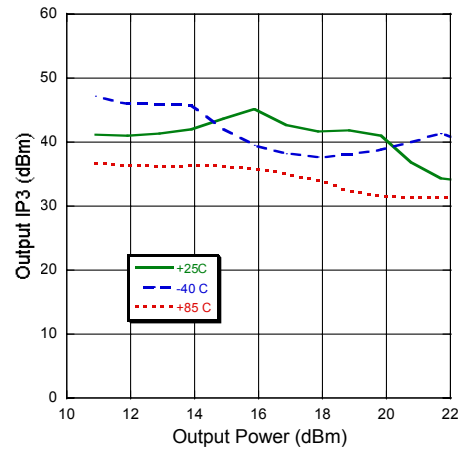

**P1dB**

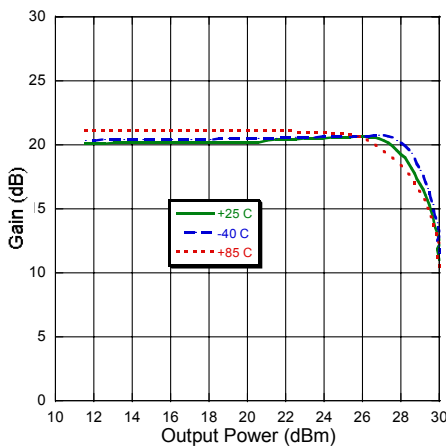



**Applications Section**

**Typical Performance Curves, 2400 MHz Configuration**

**Gain**

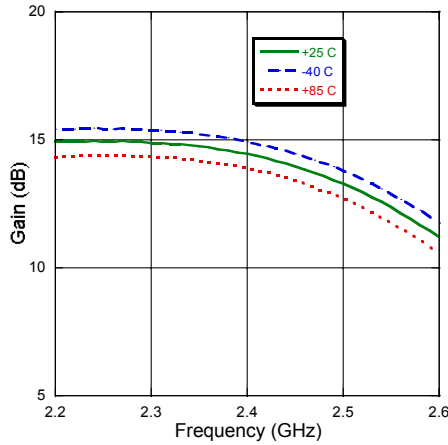

**Input Return Loss**

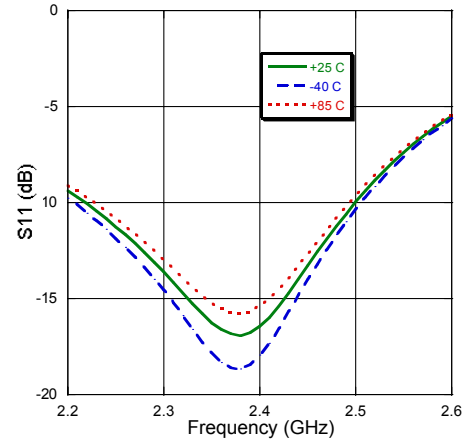

**Output Return Loss**

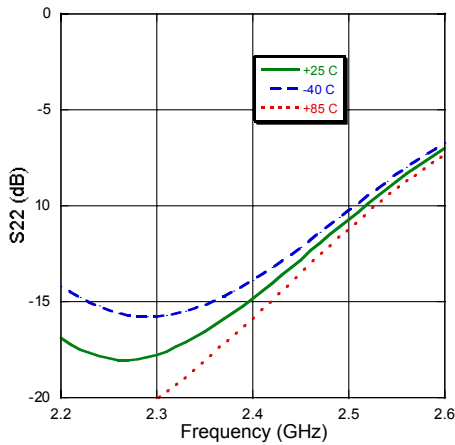

**Output IP3**

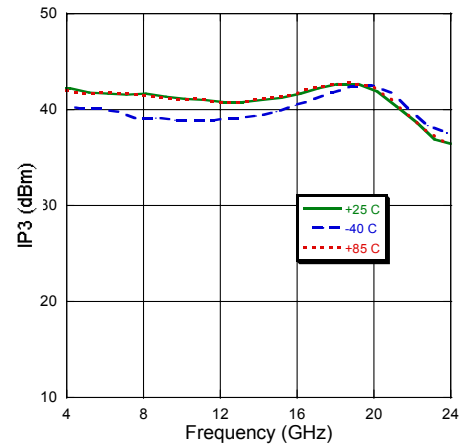

**P1dB**

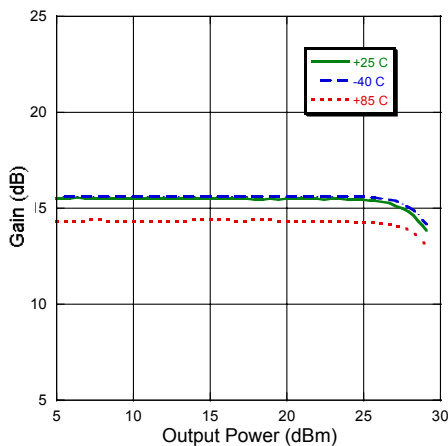

**Applications Section**

**Typical Performance Curves, 3500 MHz Configuration**

**Gain**

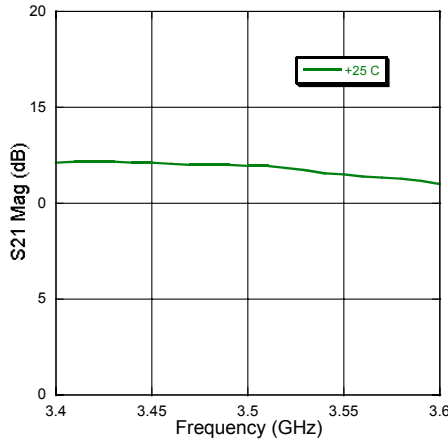

**Input Return Loss**

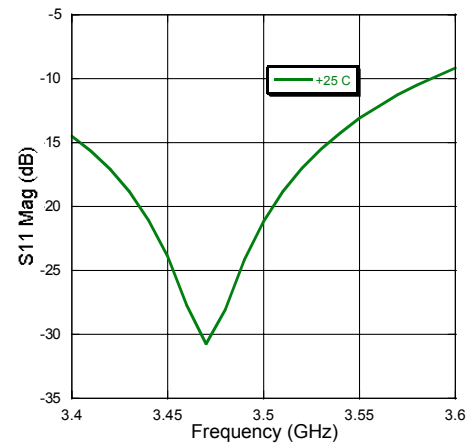

**Output Return Loss**

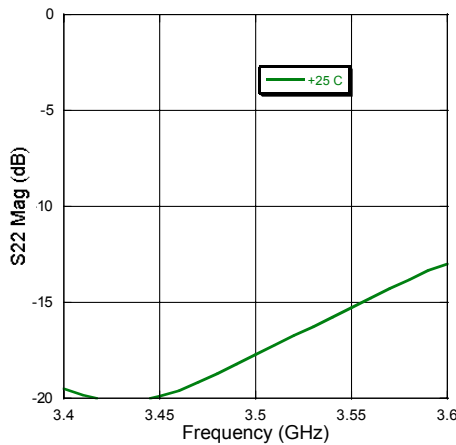

**Output IP3**

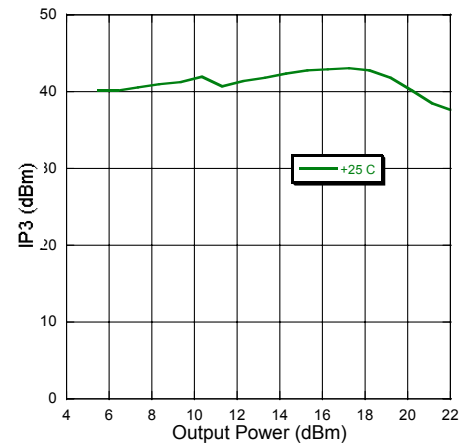

**P1dB**

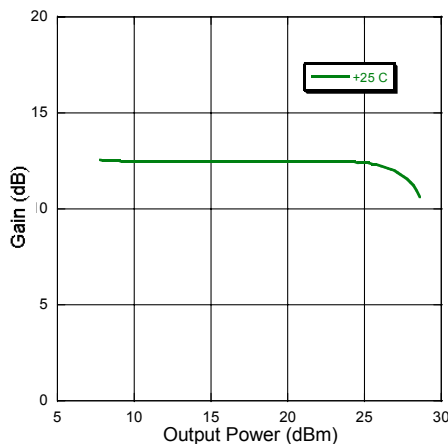

**Applications Section**

**300 MHz PCB Layout**

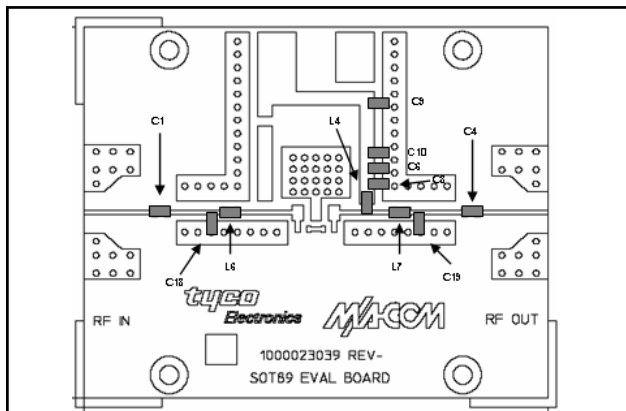

**300 MHz Schematic**

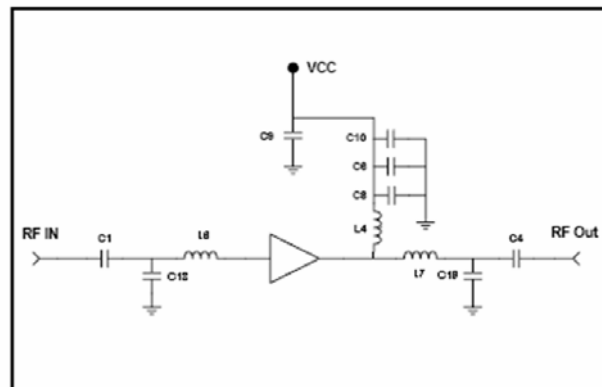

**2400 MHz PCB Layout**

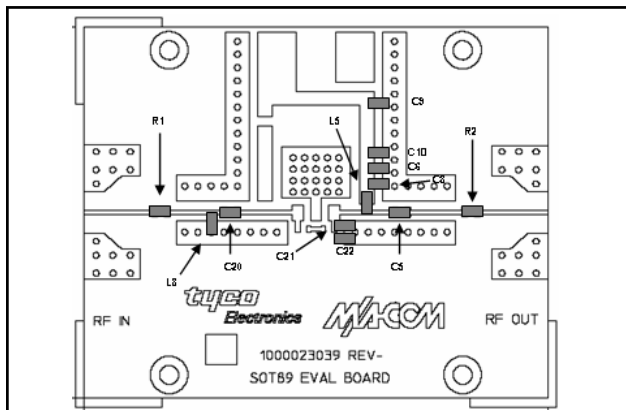

**2400 MHz Schematic**

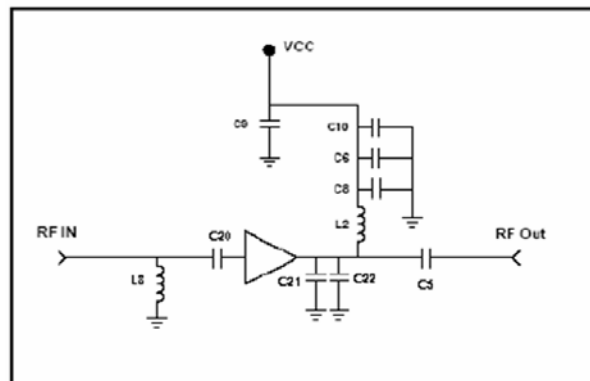

**3500 MHz PCB Layout**

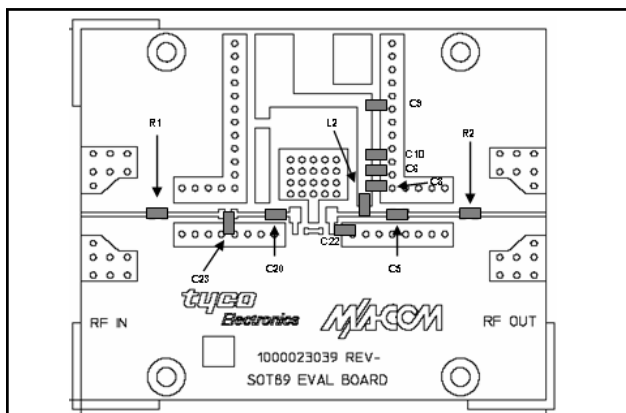

**3500 MHz Schematic**

